

Introduction

Chapter 1





Today, we look much cuter!

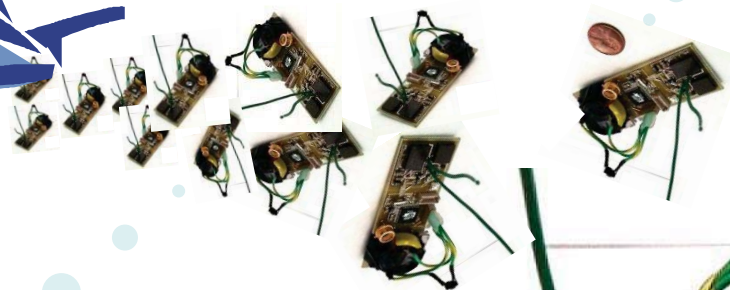

And we're usually carefully deployed

Radio

Power

Processor

Sensors

Memory

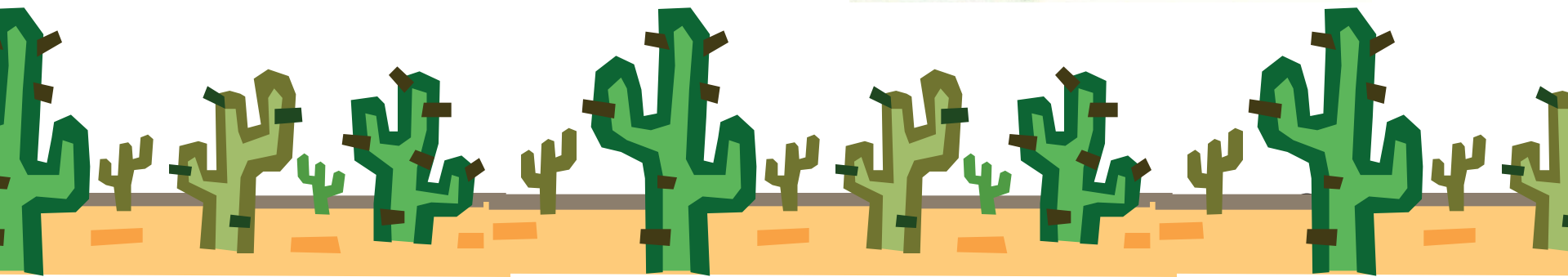
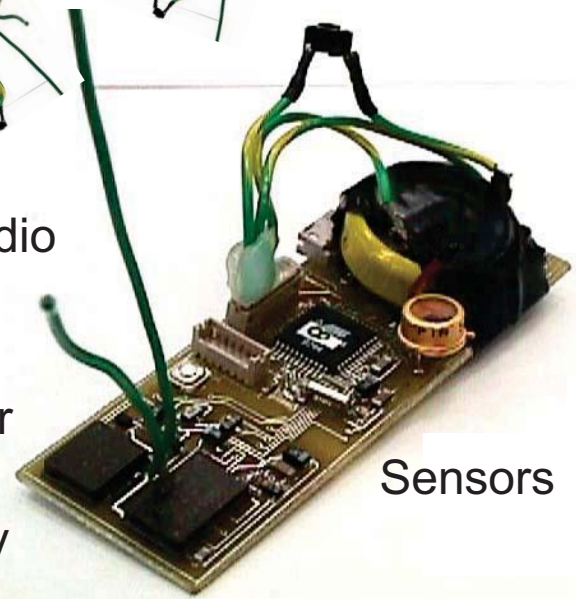

A Typical Sensor Node: TinyNode 584

[Shockfish SA, The Sensor Network Museum]

- TI MSP430F1611 microcontroller @ 8 MHz
- 10k SRAM, 48k flash (code), 512k serial storage
- 868 MHz Xemics XE1205 multi channel radio
- Up to 115 kbps data rate, 200m outdoor range

	Current Draw	Power Consumption
uC sleep with timer on	6.5 uA	0.0195 mW
uC active, radio off	2.1 mA	6.3 mW
uC active, radio idle listening	16 mA	48 mW
uC active, radio TX/RX at +12dBm	62 mA	186 mW
Max. Power (uC active, radio TX/RX at +12dBm + flash write)	76.9 mA	230.7mW

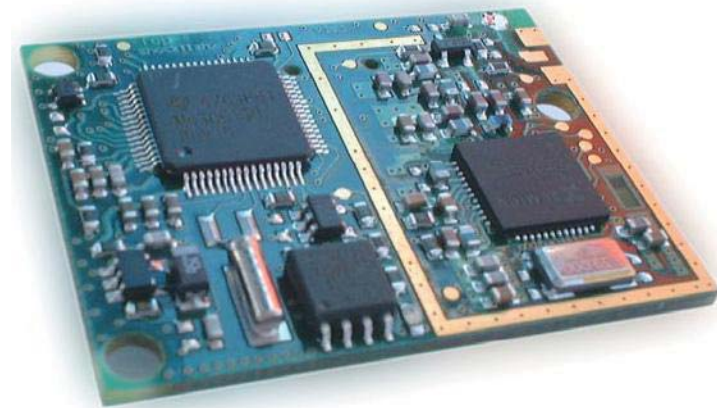

After Deployment

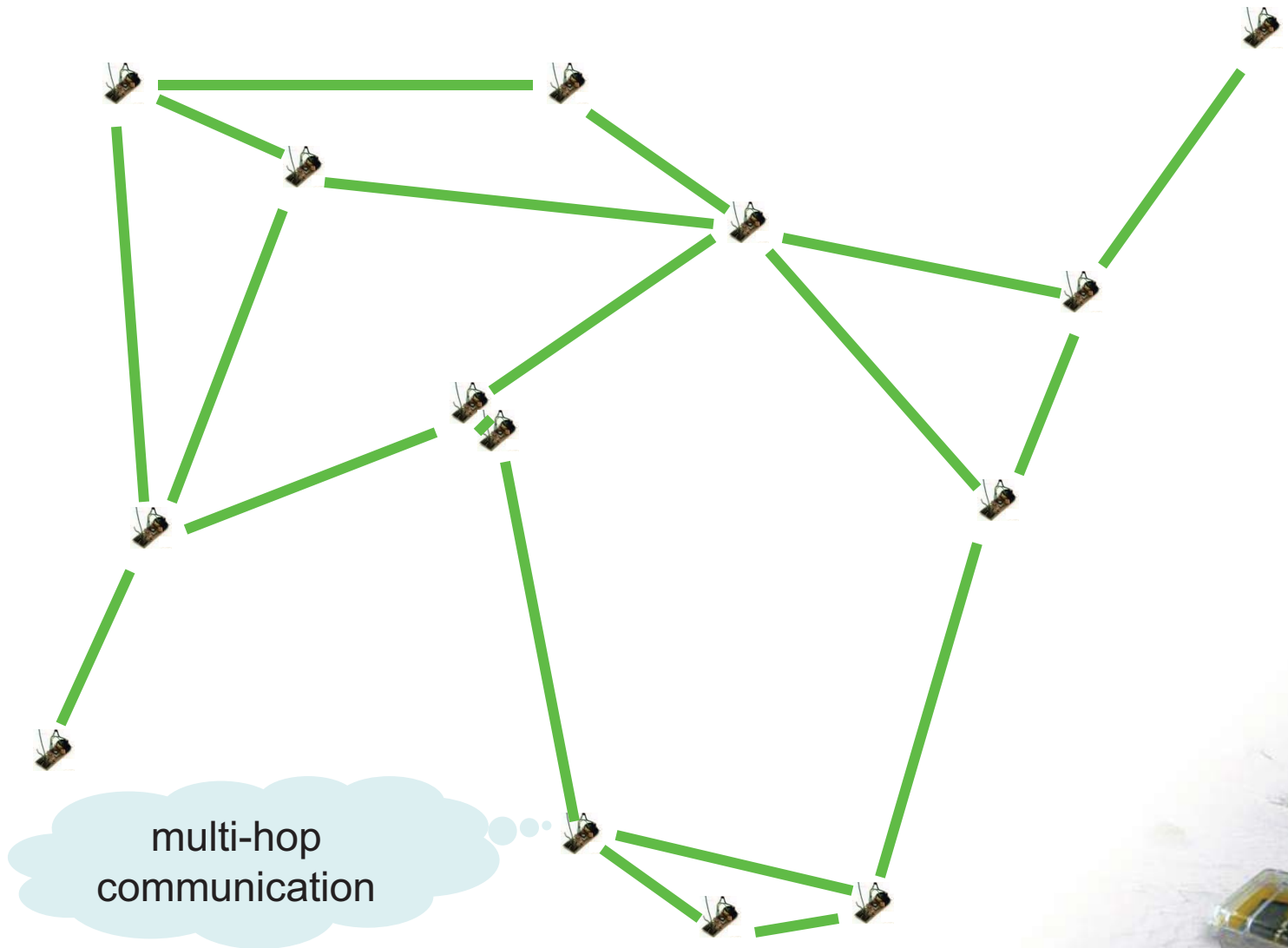

Visuals anyone?

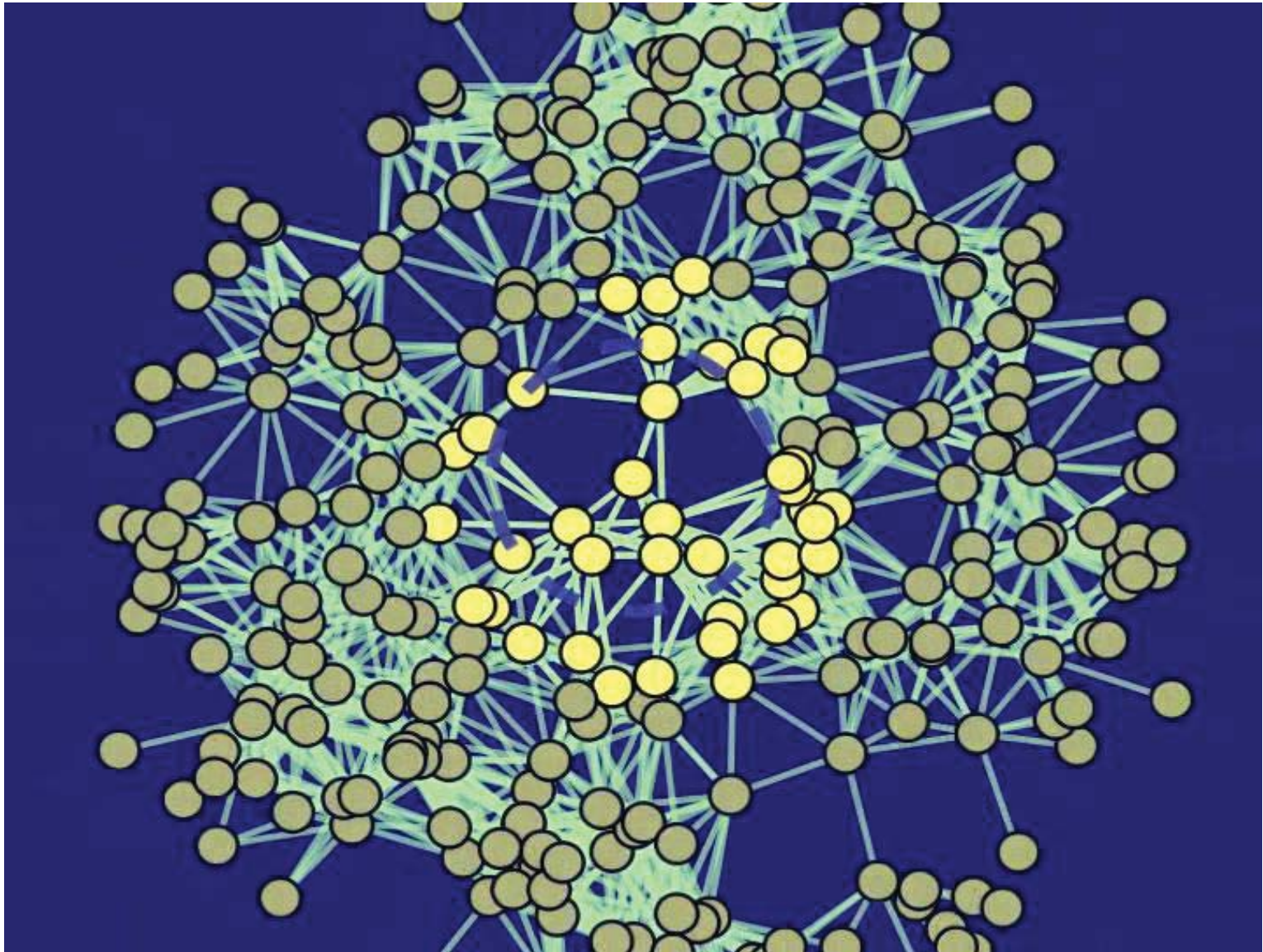

- Laptops, PDA's, cars, soldiers
- All-to-all **routing**
- Often with **mobility** (MANET's)
- **Trust/Security** an issue
 - No central coordinator
- Maybe high **bandwidth**
- **Tiny nodes**: 4 MHz, 32 kB, ...
- Broadcast/Echo from/to sink
- Usually no mobility
 - but link failures
- One administrative control
- Long lifetime → **Energy**

There is no strict separation; more variants such as mesh or sensor/actor networks exist



Overview

- Introduction
- Application Examples
- Related Areas

- Wireless Communication Basics
 - Frequencies
 - Signals
 - Antennas
 - Signal Propagation
 - Modulation

- Course Overview
- Literature



Animal Monitoring (Great Duck Island)



1. Biologists put sensors in underground nests of storm petrel
2. And on 10cm stilts
3. Devices record data about birds
4. Transmit to research station
5. And from there via satellite to lab

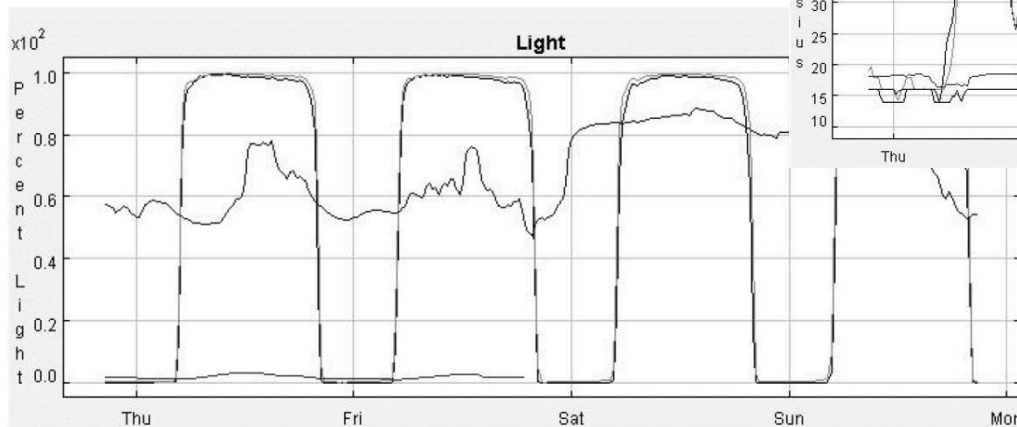
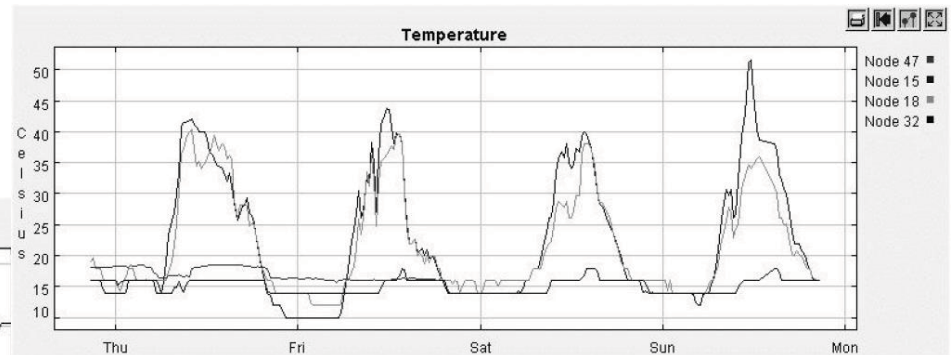

Environmental Monitoring (Redwood Tree)

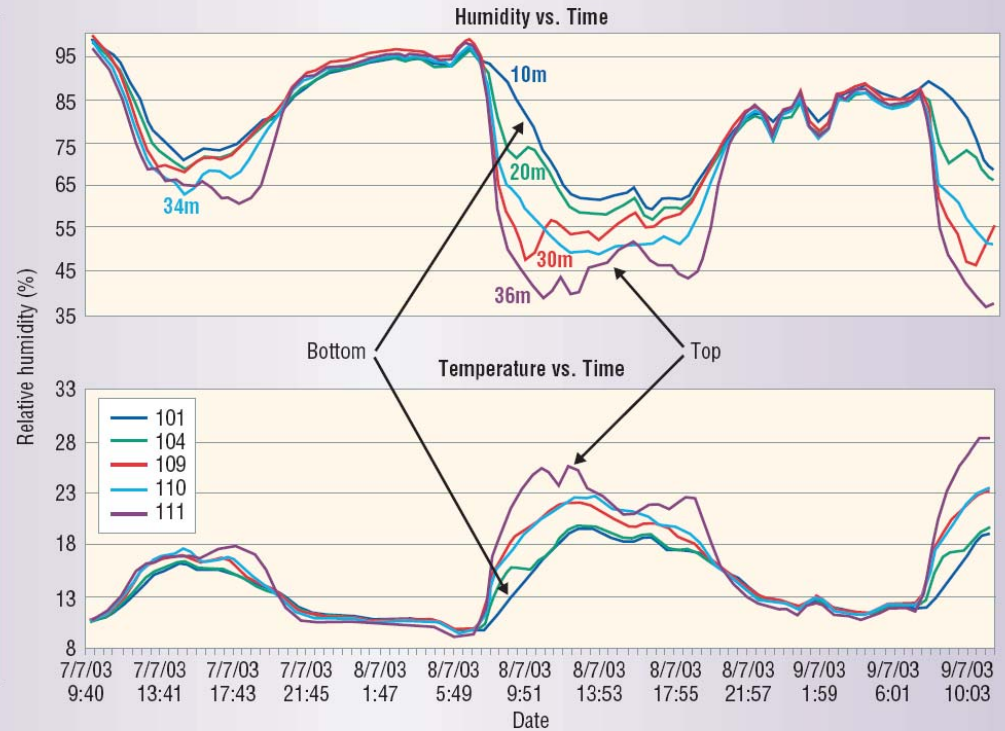

- Microclimate in a tree
- 10km less cables on a tree; easier to set up
- Sensor Network = The New Microscope?



Vehicle Tracking

- Sensor nodes (equipped with magnetometers) are packaged, and dropped from fully autonomous GPS controlled “toy” air plane
- Nodes know dropping order, and use that for initial position guess
- Nodes then track vehicles (trucks mostly)

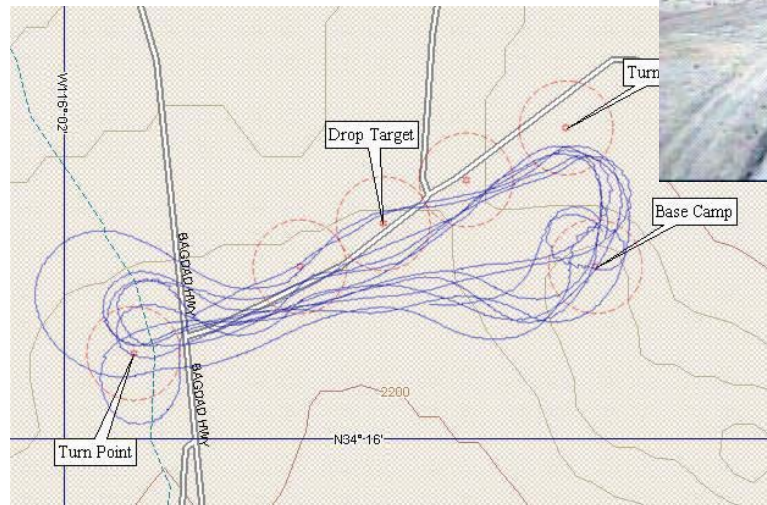

Smart Spaces (Car Parking)

- The good: Guide cars towards empty spots
- The bad: Check which cars do not have any time remaining
- The ugly: Meter running out: take picture and send fine

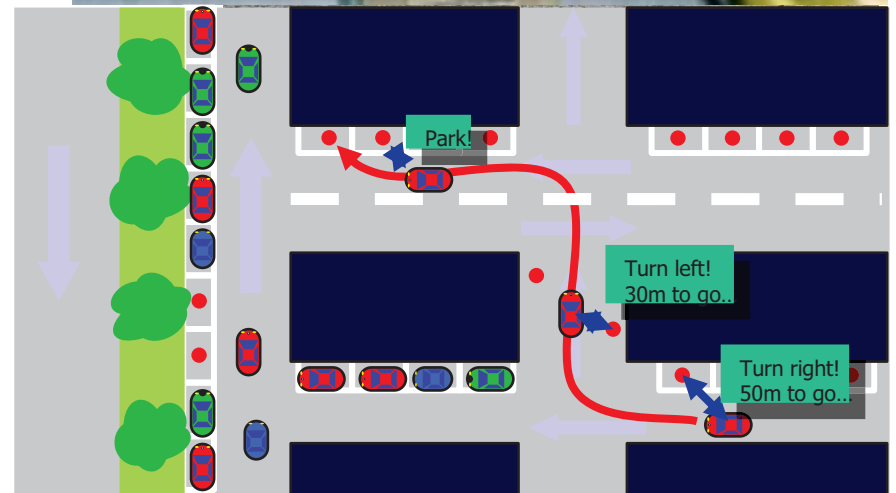

[Matthias Grossglauser, EPFL & Nokia Research]

Structural Health Monitoring (Bridge)

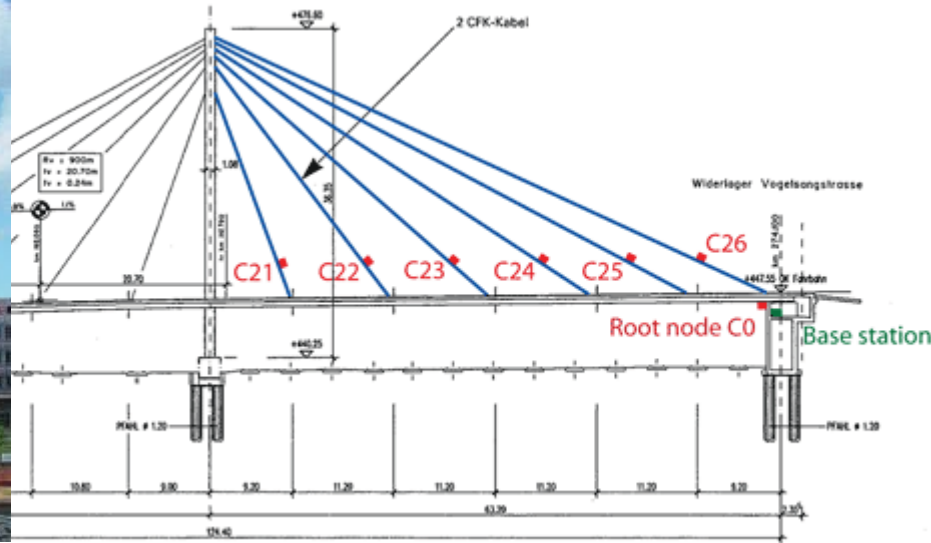

Swiss Made
[EMPA]

Detect structural defects, measuring temperature, humidity, vibration, etc.

On site (Stork Bridge)

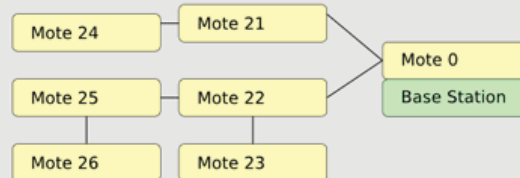

Winterthur

Remote Control

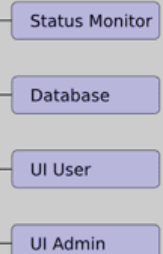

Dübendorf

Virtual Fence (CSIRO Australia)

- Download the fence to the cows. Today stay here, tomorrow go somewhere else.
- When a cow strays towards the co-ordinates, software running on the collar triggers a stimulus chosen to scare the cow away, a sound followed by an electric shock; this is the “virtual” fence. The software also "herds" the cows when the position of the virtual fence is moved.
- If you just want to make sure that cows stay together, GPS is not really needed...



Cows learn and need not to be shocked later... Moo!



Economic Forecast

[Jean-Pierre Hubaux, EPFL]

- Industrial Monitoring (35% – 45%)
 - Monitor and control production chain
 - Storage management
 - Monitor and control distribution
- Building Monitoring and Control (20 – 30%)
 - Alarms (fire, intrusion etc.)
 - Access control
- Home Automation (15 – 25%)
 - Energy management (light, heating, AC etc.)
 - Remote control of appliances
- Automated Meter Reading (10-20%)
 - Water meter, electricity meter, etc.
- Environmental Monitoring (5%)
 - Agriculture
 - Wildlife monitoring

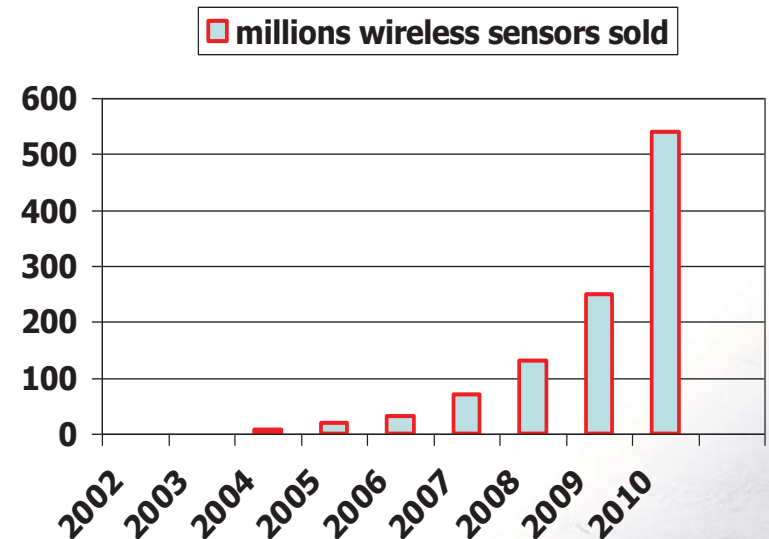

Related Areas

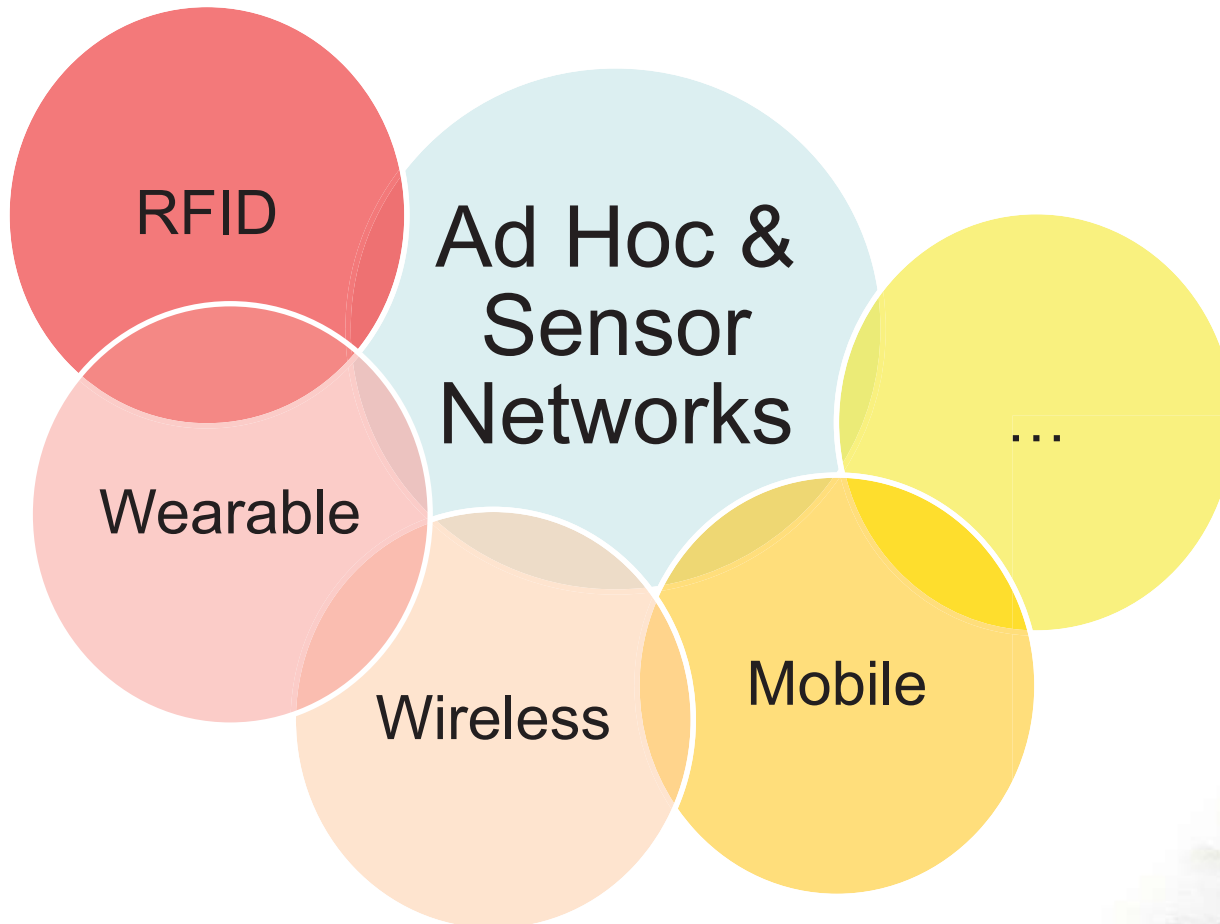

RFID Systems

- Fundamental difference between ad hoc/sensor networks and RFID: In RFID there is always the distinction between the passive tags/transponders (tiny/flat), and the reader (bulky/big).
- There is another form of tag, the so-called **active tag**, which has its own internal power source that is used to power the integrated circuits and to broadcast the signal to the reader. An active tag is similar to a sensor node.
- More types are available, e.g. the **semi-passive tag**, where the battery is not used for transmission (but only for computing)

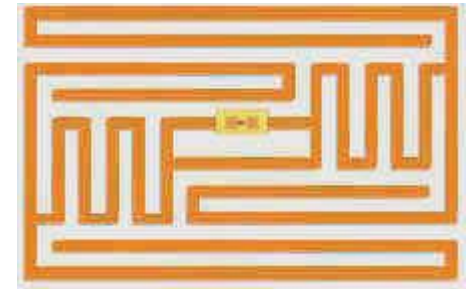

Wearable Computing / Ubiquitous Computing

- Tiny embedded “computers”
- UbiComp: Microsoft’s Doll
- I refer to my colleague Gerhard Troester and his lectures & seminars



[Schiele, Troester]



Wireless and/or Mobile

- Aspects of mobility
 - User mobility: users communicate “anytime, anywhere, with anyone” (example: read/write email on web browser)
 - Device portability: devices can be connected anytime, anywhere to the network
- Wireless vs. mobile Examples

✗	✗	Stationary computer
✗	✓	Notebook in a hotel
✓	✗	Historic buildings; last mile
✓	✓	Personal Digital Assistant (PDA)
- The demand for mobile communication creates the need for integration of wireless networks and existing fixed networks
 - Local area networks: standardization of IEEE 802.11 or HIPERLAN
 - Wide area networks: GSM and ISDN
 - Internet: Mobile IP extension of the Internet protocol IP



Wireless & Mobile Examples

- Up-to-date localized information
 - Map
 - Pull/Push
- Ticketing
- Etc.

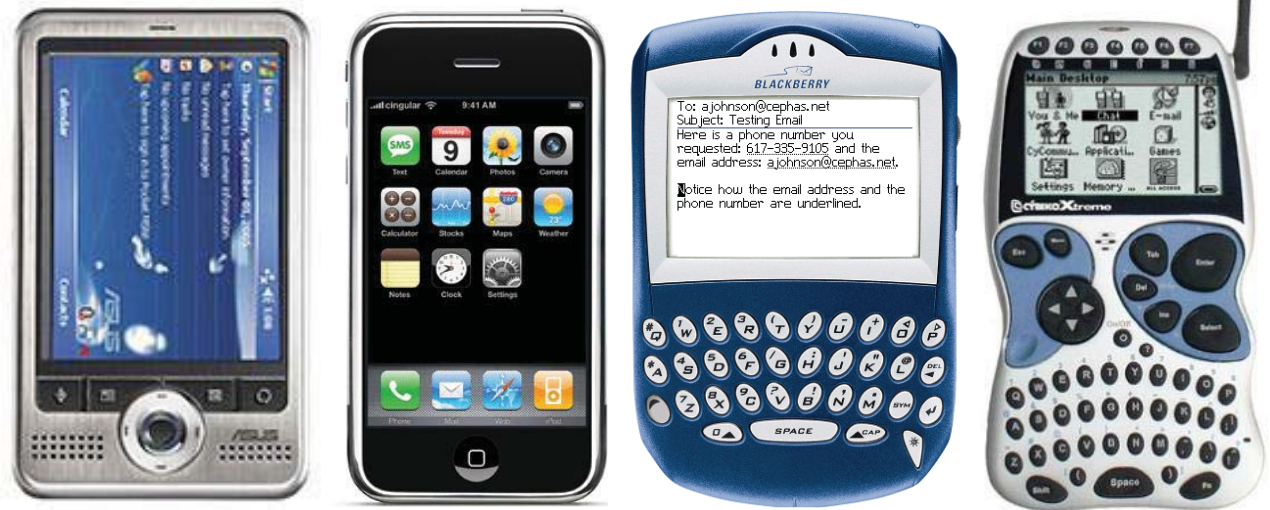

[Asus PDA, iPhone, Blackberry, Cybiko]



General Trend: A computer in 10 years?

- Advances in technology
 - More computing power in smaller devices
 - Flat, lightweight displays with low power consumption
 - New user interfaces due to small dimensions
 - More bandwidth (per second? per space?)
 - Multiple wireless techniques
- Technology in the background
 - Device location awareness: computers adapt to their environment
 - User location awareness: computers recognize the location of the user and react appropriately (call forwarding)
- “Computers” evolve
 - Small, cheap, portable, replaceable
 - Integration or disintegration?



Physical Layer: Wireless Frequencies

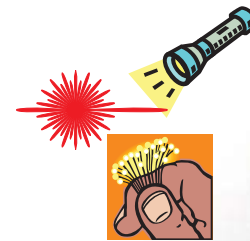
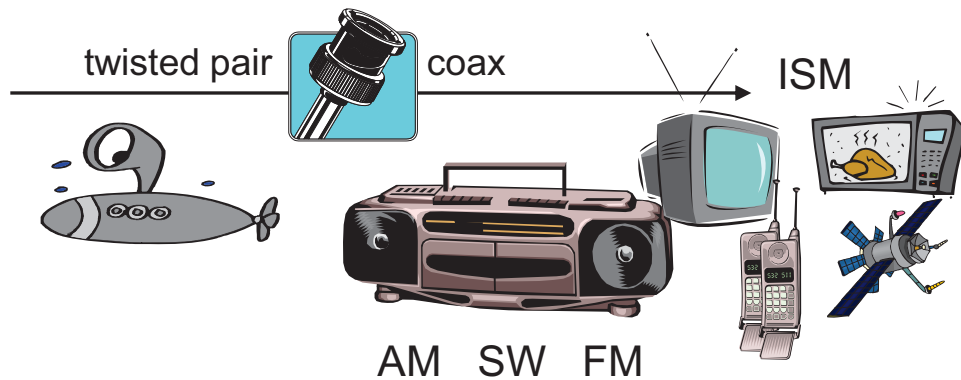
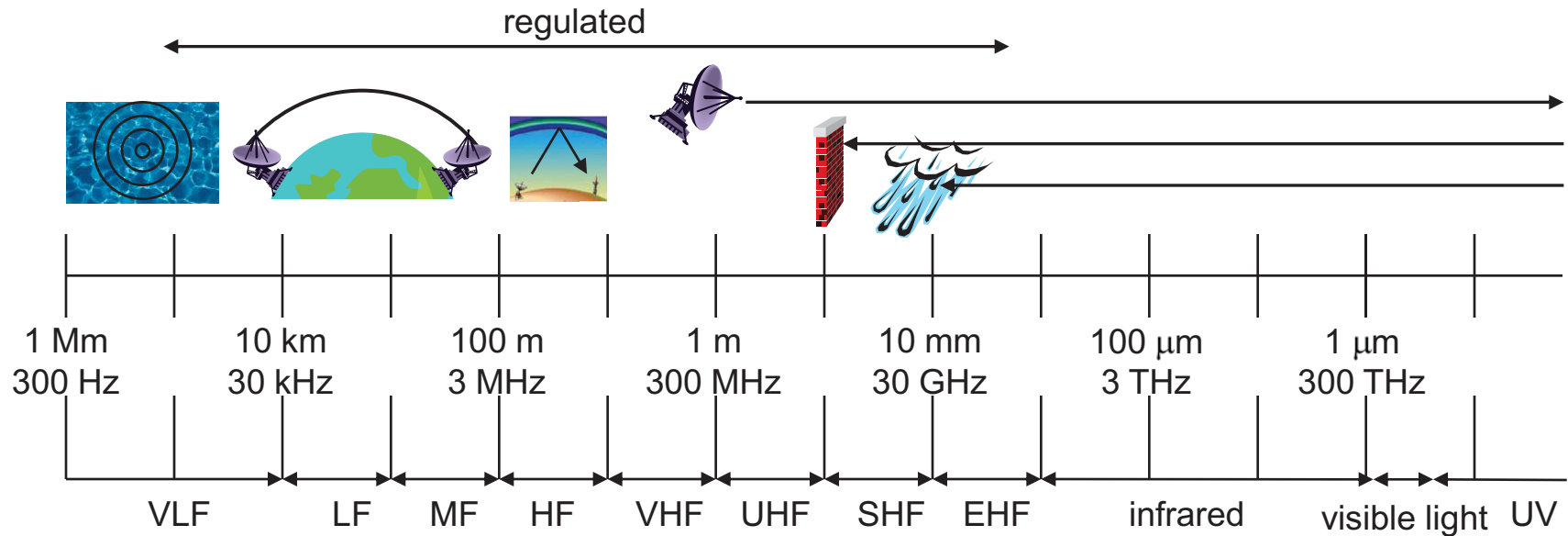

Frequencies and Regulations

- ITU-R holds auctions for new frequencies, manages frequency bands worldwide (WRC, World Radio Conferences)

	Europe (CEPT/ETSI)	USA (FCC)	Japan
Mobile phones	NMT 453-457MHz, 463-467 MHz GSM 890-915 MHz, 935-960 MHz, 1710-1785 MHz, 1805-1880 MHz	AMPS, TDMA, CDMA 824-849 MHz, 869-894 MHz TDMA, CDMA, GSM 1850-1910 MHz, 1930-1990 MHz	PDC 810-826 MHz, 940-956 MHz, 1429-1465 MHz, 1477-1513 MHz
Cordless telephones	CT1+ 885-887 MHz, 930-932 MHz CT2 864-868 MHz DECT 1880-1900 MHz	PACS 1850-1910 MHz, 1930-1990 MHz PACS-UB 1910-1930 MHz	PHS 1895-1918 MHz JCT 254-380 MHz
Wireless LANs	IEEE 802.11 2400-2483 MHz HIPERLAN 1 5176-5270 MHz	IEEE 802.11 2400-2483 MHz	IEEE 802.11 2471-2497 MHz



Signal propagation ranges, a simplified model

- Propagation in free space always like light (straight line)
- Transmission range
 - communication possible
 - low error rate
- Detection range
 - detection of the signal possible
 - no communication possible
- Interference range
 - signal may not be detected
 - signal adds to the background noise

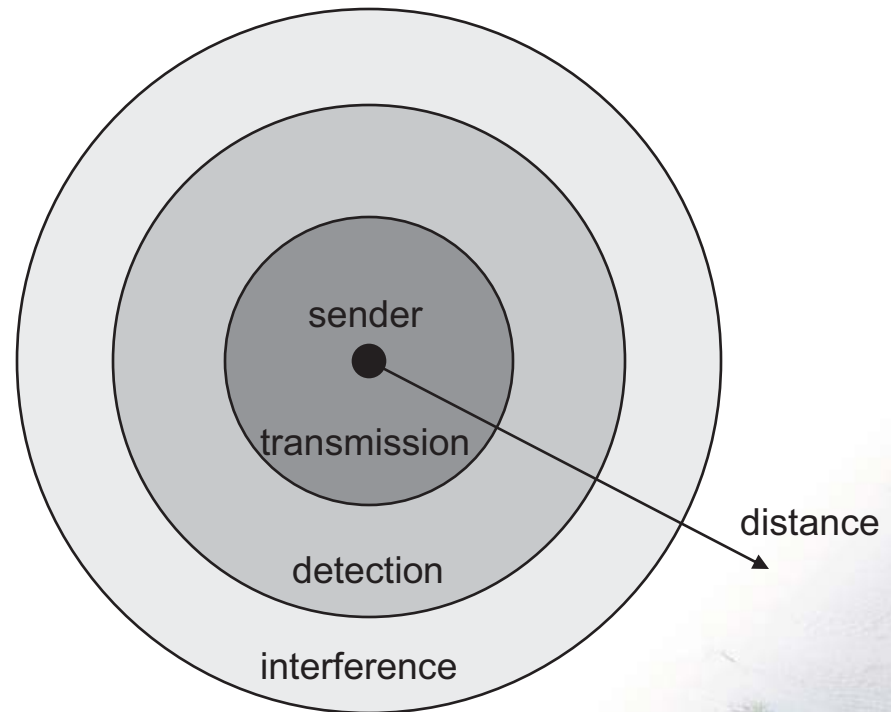

Signal propagation, more accurate models

- **Free space propagation** $P_r = \frac{P_s G_s G_r \lambda^2}{(4\pi)^2 d^2 L}$
- **Two-ray ground propagation** $P_r = \frac{P_s G_s G_r h_s^2 h_r^2}{d^4}$
- P_s, P_r : Power of radio signal of sender resp. receiver
- G_s, G_r : Antenna gain of sender resp. receiver (how bad is antenna)
- d : Distance between sender and receiver
- L : System loss factor
- λ : Wavelength of signal in meters
- h_s, h_r : Antenna height above ground of sender resp. receiver
- Plus, in practice, received power is not constant („fading“)



Attenuation by distance

- Attenuation [dB] = $10 \log_{10}$ (transmitted power / received power)
- Example: factor 2 loss = $10 \log_{10} 2 \approx 3$ dB
- In theory/vacuum (and for short distances), receiving power is proportional to $1/d^2$, where d is the distance.
- In practice (for long distances), receiving power is proportional to $1/d^\alpha$, $\alpha = 4 \dots 6$. We call α the path loss exponent.
- Example: Short distance, what is the attenuation between 10 and 100 meters distance?
Factor 100 ($=100^2/10^2$) loss = 20 dB

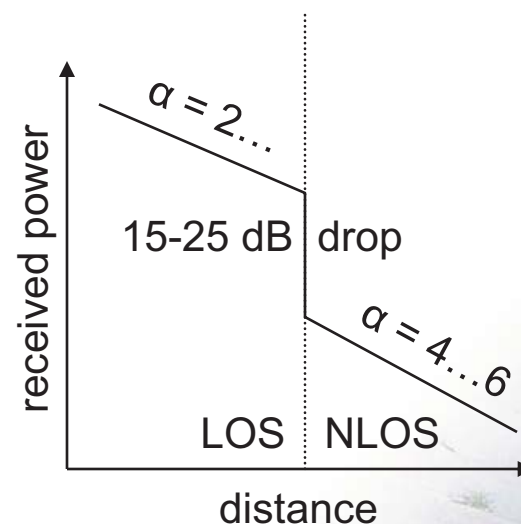

Antennas: isotropic radiator

- Radiation and reception of electromagnetic waves, coupling of wires to space for radio transmission
- Isotropic radiator: equal radiation in all three directions
- Only a theoretical reference antenna
- Radiation pattern: measurement of radiation around an antenna
- Sphere: $S = 4\pi r^2$

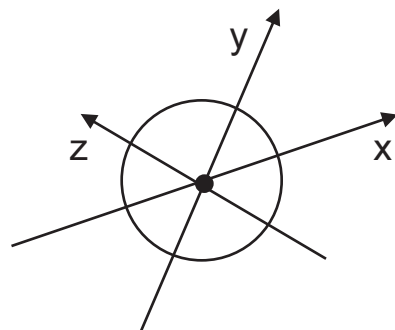
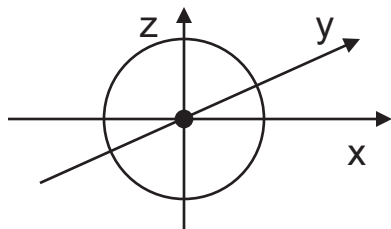

ideal
isotropic
radiator



Antennas: simple dipoles

- Real antennas are not isotropic radiators but, e.g., dipoles with lengths $\lambda/2$ as Hertzian dipole or $\lambda/4$ on car roofs or shape of antenna proportional to wavelength



- Example: Radiation pattern of a simple Hertzian dipole

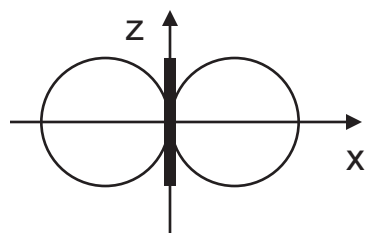

side view (xz-plane)

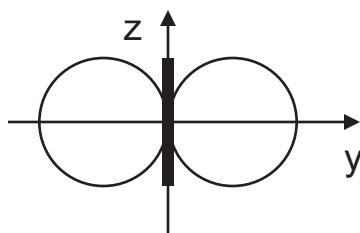

side view (yz-plane)

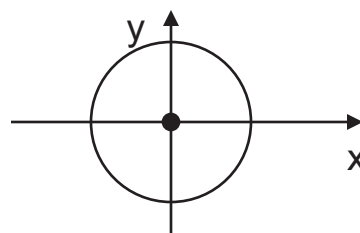

top view (xy-plane)

simple
dipole



Antennas: directed and sectorized

- Often used for microwave connections or base stations for mobile phones (e.g., radio coverage of a valley)

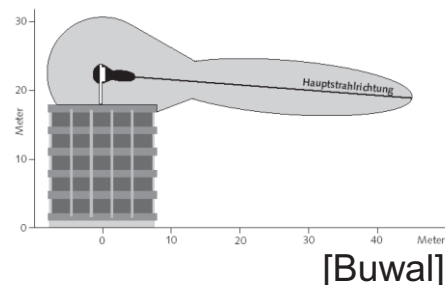
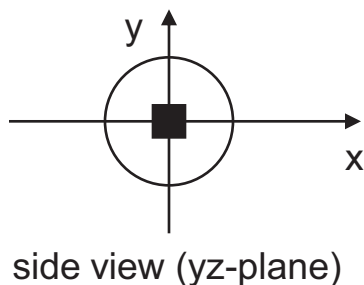
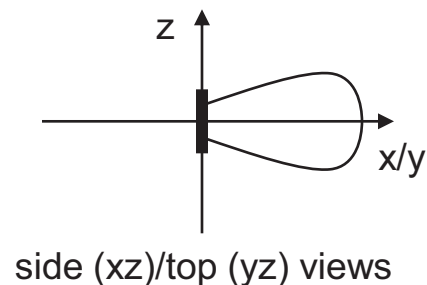

directed antenna

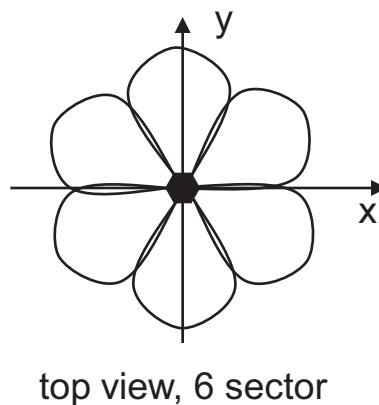
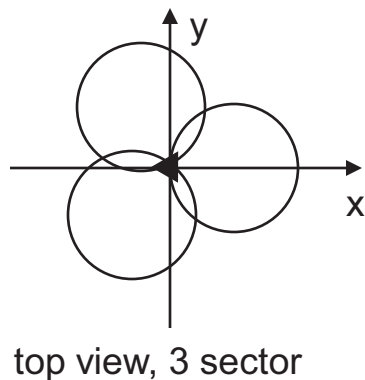

sectorized antenna



Antennas: diversity

- Grouping of 2 or more antennas
 - multi-element antenna arrays
- Antenna diversity
 - switched diversity, selection diversity
 - receiver chooses antenna with largest output
 - diversity combining
 - combine output power to produce gain
 - cophasing needed to avoid cancellation

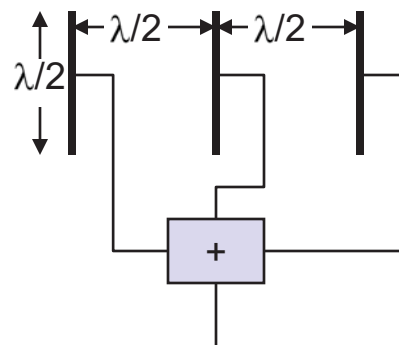
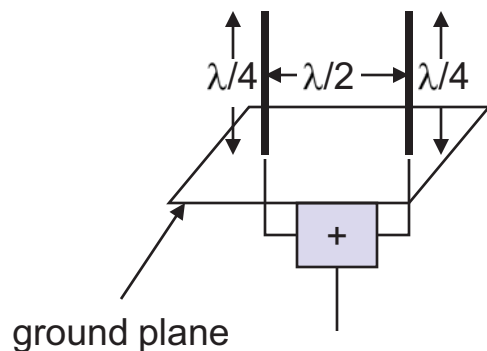

- Smart antenna: beam-forming, MIMO, etc.



Real World Examples

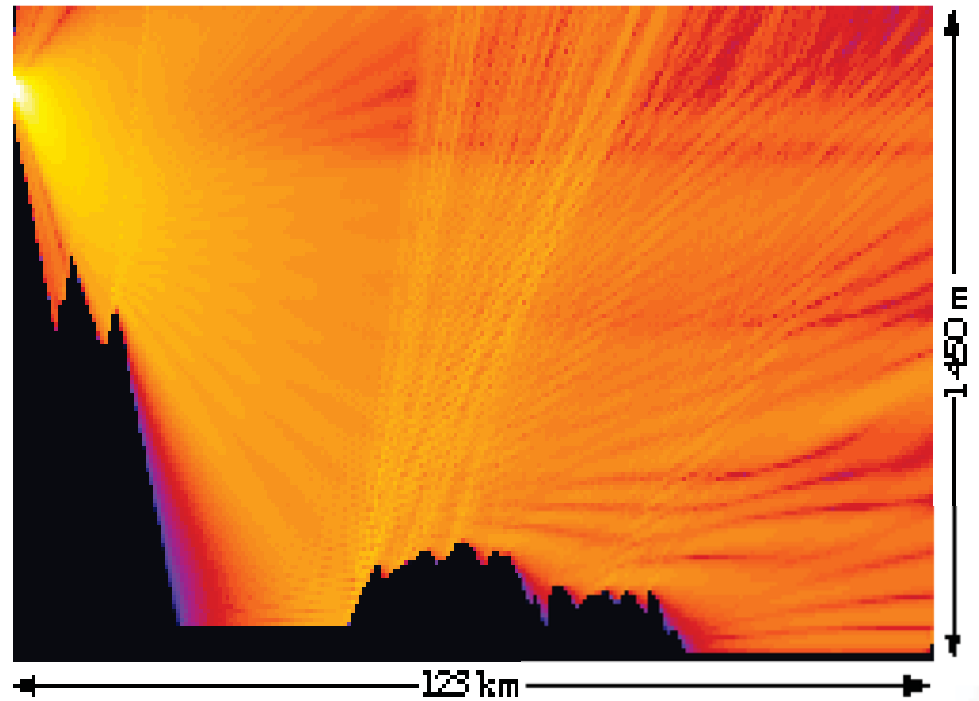
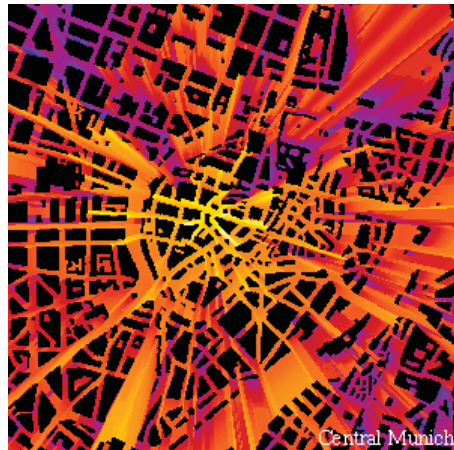
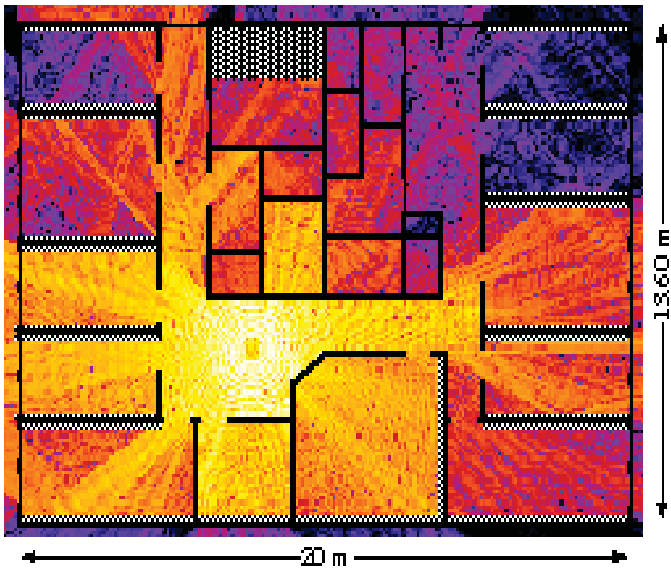

Attenuation by objects

- Shadowing (3-30 dB):
 - textile (3 dB)
 - concrete walls (13-20 dB)
 - floors (20-30 dB)
- reflection at large obstacles
- scattering at small obstacles
- diffraction at edges
- fading (frequency dependent)

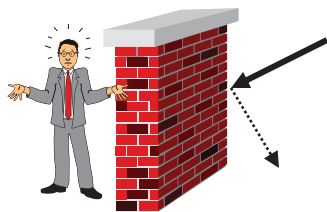

shadowing

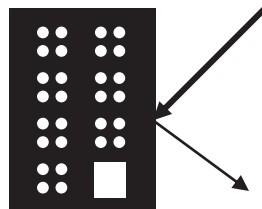

reflection



scattering



diffraction



Multipath propagation

- Signal can take many different paths between sender and receiver due to reflection, scattering, diffraction

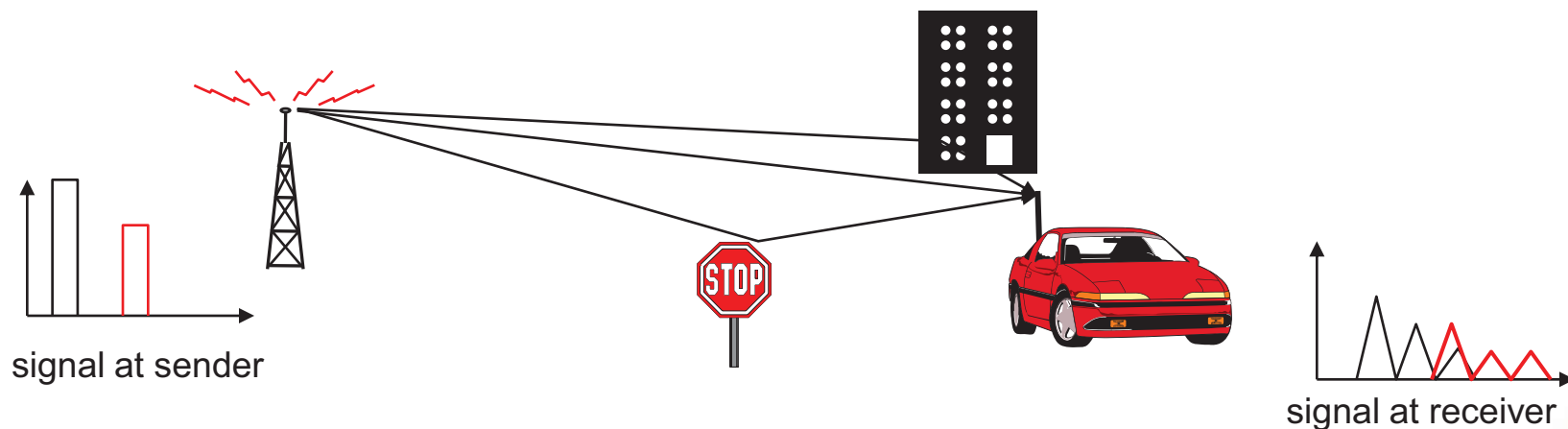

- Time dispersion: signal is dispersed over time
- Interference with “neighbor” symbols: Inter Symbol Interference (ISI)
- The signal reaches a receiver directly and phase shifted
- Distorted signal depending on the phases of the different parts

Effects of mobility

- Channel characteristics change over time and location
 - signal paths change
 - different delay variations of different signal parts
 - different phases of signal parts
- quick changes in power received (short term fading)
- Additional changes in
 - distance to sender
 - obstacles further away
- slow changes in average power received (long term fading)
- Doppler shift: Random frequency modulation

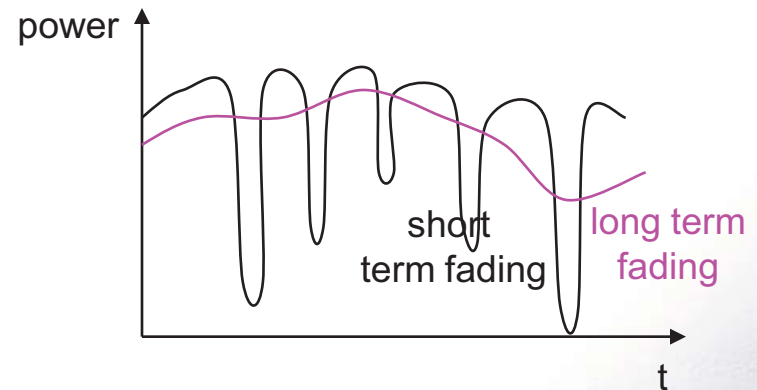

Periodic Signals

- $g(t) = A_t \sin(2\pi f_t t + \varphi_t)$
- Amplitude A
- frequency f [Hz = 1/s]
- period $T = 1/f$
- wavelength λ
with $\lambda f = c$
($c=3 \cdot 10^8$ m/s)
- phase φ
- $\varphi^* = -\varphi T/2\pi$ [+T]

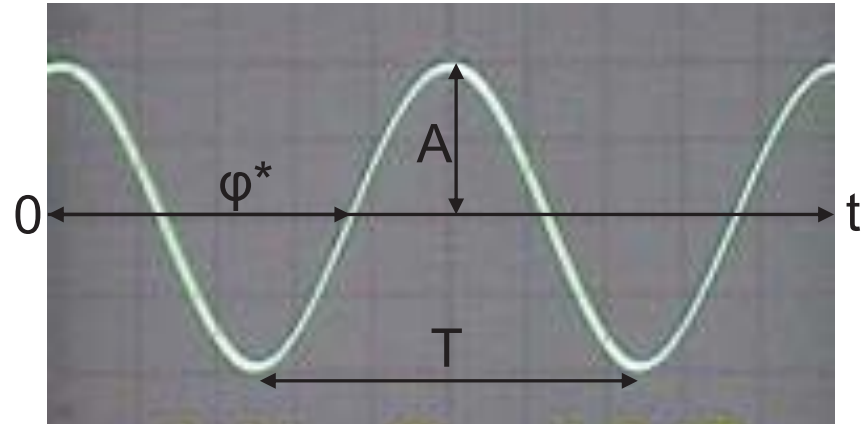

Modulation and demodulation

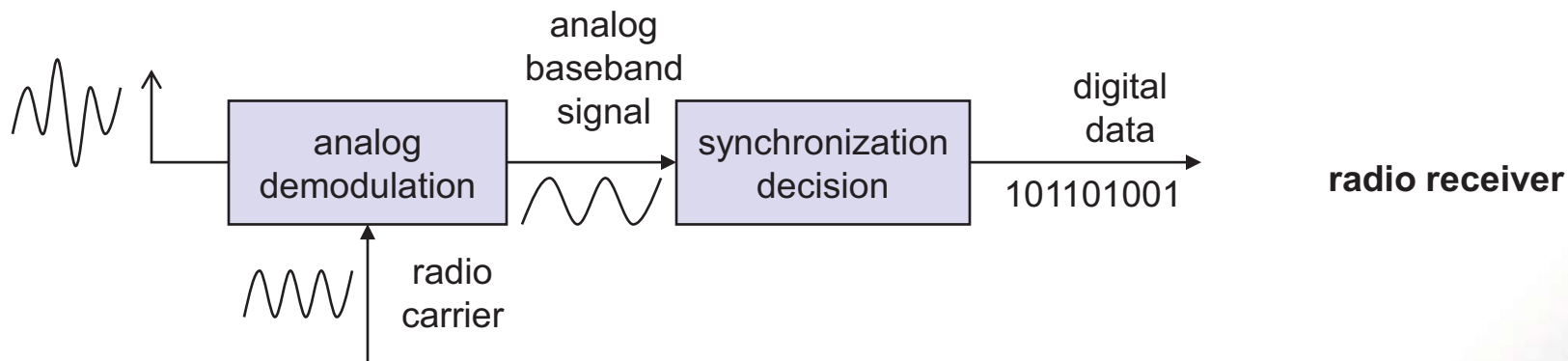
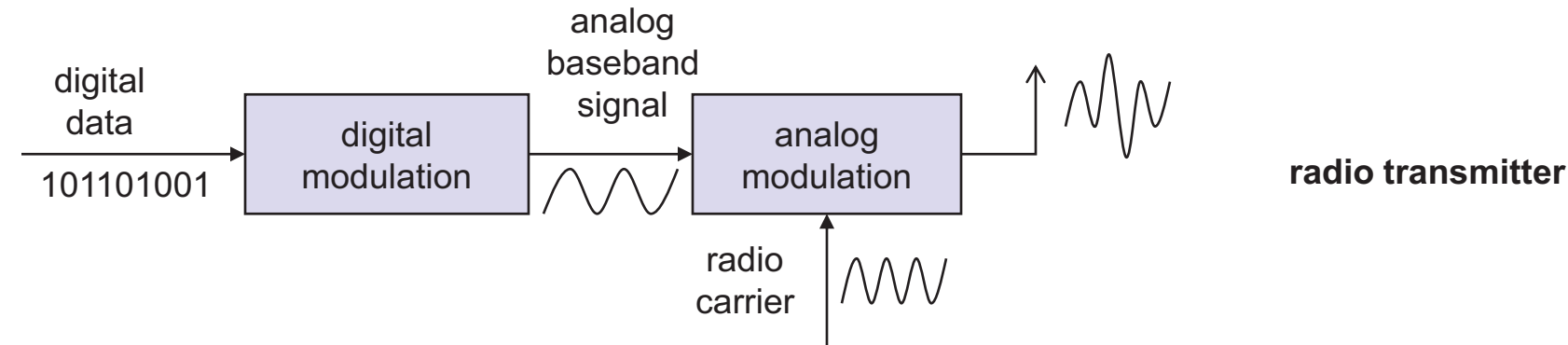

- Modulation in action:

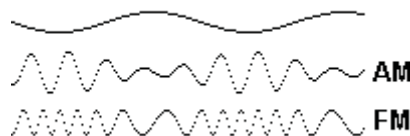

Digital modulation

- Modulation of digital signals known as Shift Keying

- Amplitude Shift Keying (ASK):
 - very simple
 - low bandwidth requirements
 - very susceptible to interference
- Frequency Shift Keying (FSK):
 - needs larger bandwidth
- Phase Shift Keying (PSK):
 - more complex
 - robust against interference

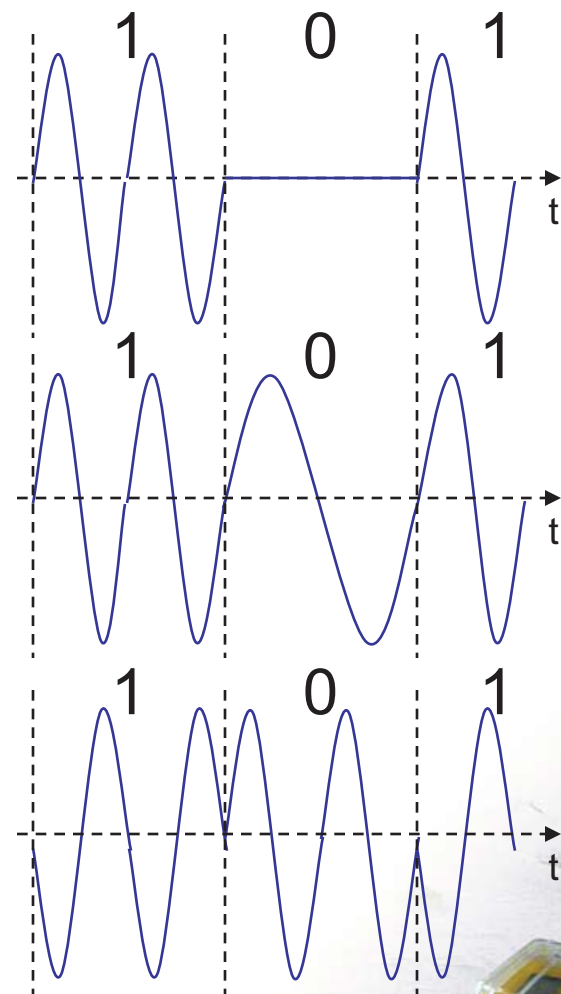

Different representations of signals

- For many modulation schemes not all parameters matter.

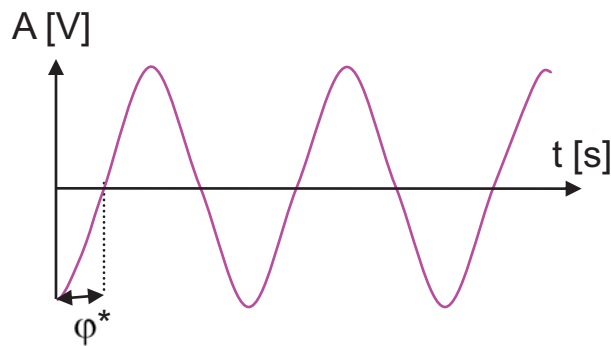

amplitude domain

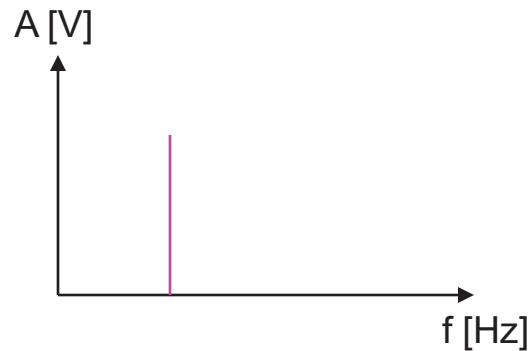

frequency spectrum

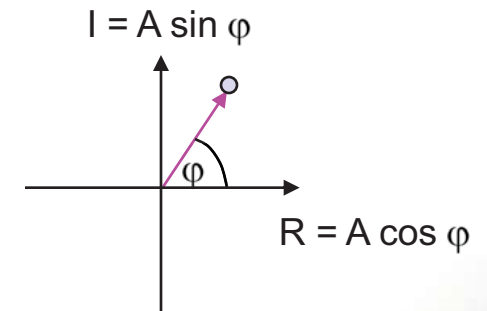

phase state diagram



Advanced Frequency Shift Keying

- MSK (Minimum Shift Keying)
- bandwidth needed for FSK depends on the distance between the carrier frequencies
- Avoid sudden phase shifts by choosing the frequencies such that (minimum) frequency gap $\delta f = 1/4T$ (where T is a bit time)
- During T the phase of the signal changes continuously to $\pm \pi$
- Example GSM: GMSK (Gaussian MSK)



Advanced Phase Shift Keying

- BPSK (Binary Phase Shift Keying):

- bit value 0: sine wave
- bit value 1: inverted sine wave
- Robust, low spectral efficiency
- Example: satellite systems

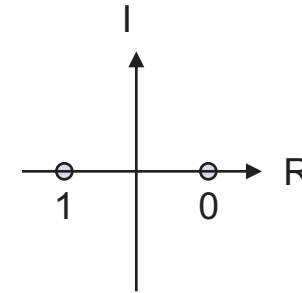

- QPSK (Quadrature Phase Shift Keying):

- 2 bits coded as one symbol
- symbol determines shift of sine wave
- needs less bandwidth compared to BPSK
- more complex

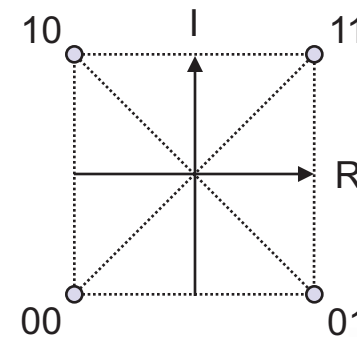

- Dxxxx (Differential xxxx)



Modulation Combinations

- Quadrature Amplitude Modulation (QAM)
- combines amplitude and phase modulation
- it is possible to code n bits using one symbol
- 2^n discrete levels, $n=2$ identical to QPSK
- bit error rate increases with n , but less errors compared to comparable PSK schemes
- Example: 16-QAM (4 bits = 1 symbol)
- Symbols 0011 and 0001 have the same phase, but different amplitude. 0000 and 1000 have different phase, but same amplitude.
- Used in 9600 bit/s modems

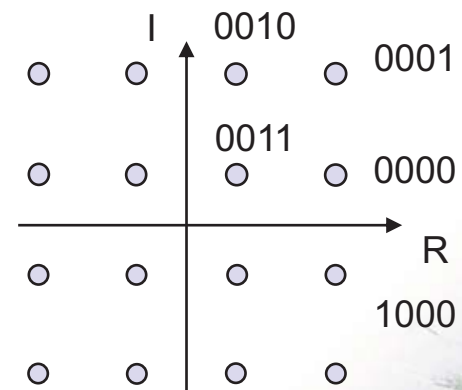

Ultra-Wideband (UWB)

- An example of a new physical paradigm.
- Discard the usual dedicated frequency band paradigm.
- Instead share a large spectrum (about 1-10 GHz).
- Modulation: Often pulse-based systems. Use extremely short duration pulses (sub-nanosecond) instead of continuous waves to transmit information. Depending on application 1M-2G pulses/second

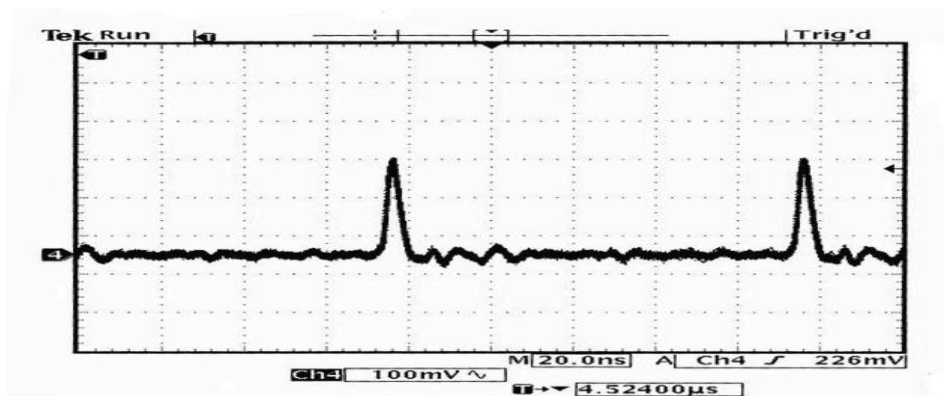

UWB Modulation

- PPM: Position of pulse
- PAM: Strength of pulse
- OOK: To pulse or not to pulse
- Or also pulse shape

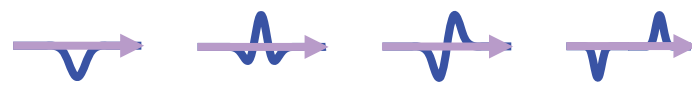
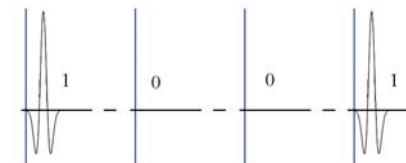
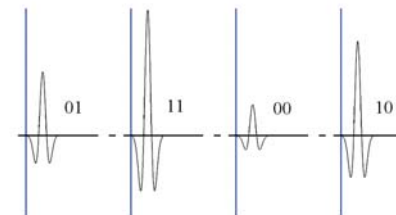
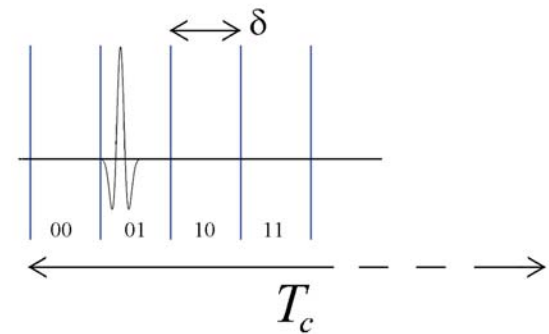

Course Overview

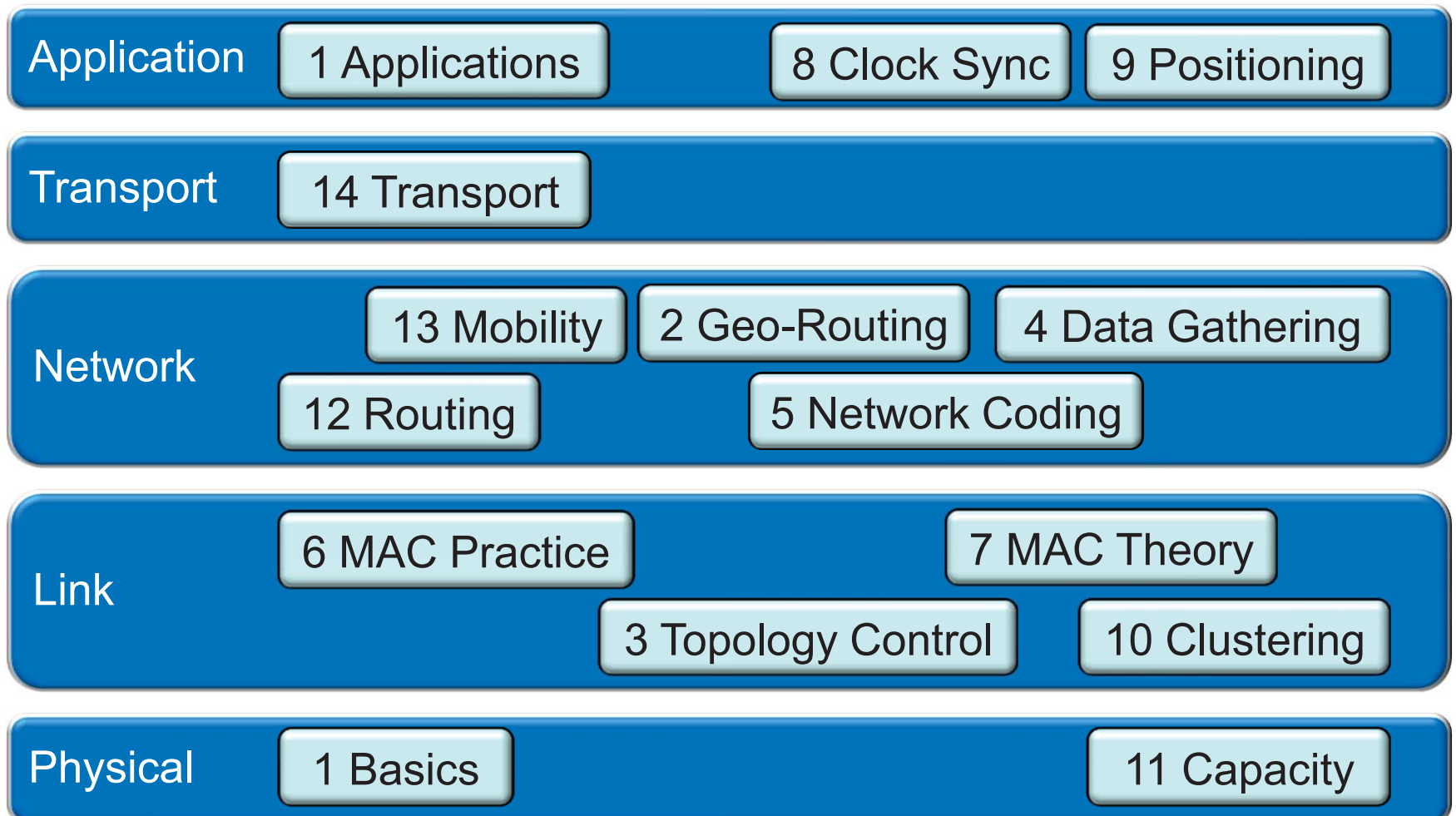

Course Overview: Lecture and Exercises

- Maximum possible spectrum of theory and practice
- **New area**, more open than closed questions
- Each week, exactly one topic (chapter)

- General ideas, concepts, algorithms, impossibility results, etc.
 - Most of these are **applicable in other contexts**
 - In other words, almost **no protocols**

- Two **types of exercises**: theory/paper, practice/lab
- Assistants: Philipp Sommer, Johannes Schneider

- www.disco.ethz.ch → courses



Literature

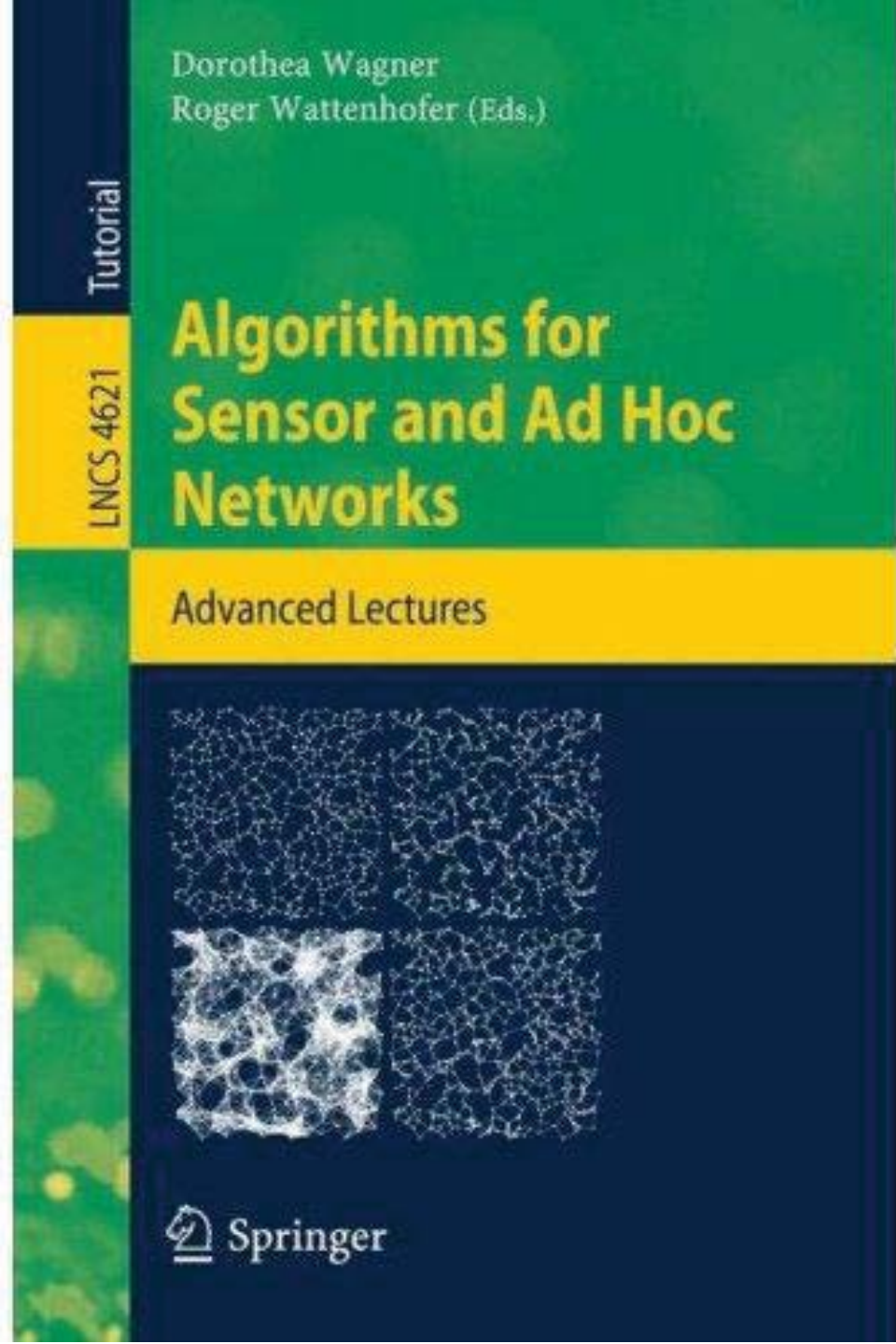

Dorothea Wagner
Roger Wattenhofer (Eds.)

Tutorial

LNCS 4621

Algorithms for Sensor and Ad Hoc Networks

Advanced Lectures

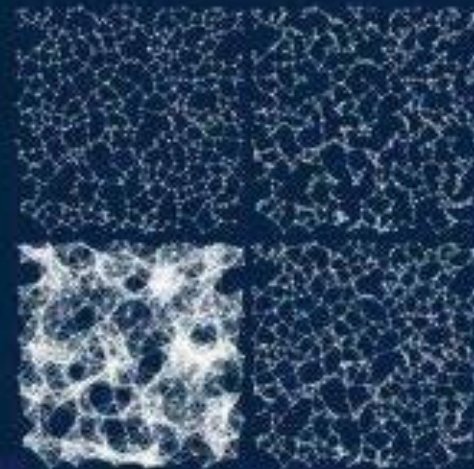

 Springer

More Literature

- Bhaskar Krishnamachari – *Networking Wireless Sensors*
- Paolo Santi – *Topology Control in Wireless Ad Hoc and Sensor Networks*
- F. Zhao and L. Guibas – *Wireless Sensor Networks: An Information Processing Approach*
- Ivan Stojmenovic – *Handbook of Wireless Networks and Mobile Computing*
- C. Siva Murthy and B. S. Manoj – *Ad Hoc Wireless Networks*
- Jochen Schiller – *Mobile Communications*
- Charles E. Perkins – *Ad-hoc Networking*
- Andrew Tanenbaum – *Computer Networks*

- *Plus tons of other books/articles*
- *Papers, papers, papers, ...*

Rating (of Applications)

- Area maturity

First steps

Text book

- Practical importance

No apps

Mission critical

- Theory appeal

Booooooring

Exciting



Open Problem

- Well, the open problem for this chapter is obvious:
- **Find the killer application!** Get rich and famous!!

...this lecture is only superficially about ad hoc and sensor networks. In reality it is about new (and hopefully exciting) networking paradigms!

