

# *Practice: Large Systems*

## *Chapter 7*



*Roger Wattenhofer*

# Overview

- Introduction
- Strong Consistency
  - Crash Failures: Primary Copy, Commit Protocols
  - Crash-Recovery Failures: Paxos, Chubby
  - Byzantine Failures: PBFT, Zyzzyva
- CAP: Consistency or Availability?
- Weak Consistency
  - Consistency Models
  - Peer-to-Peer, Distributed Storage, or Cloud Computing
  - Selfishness & Glimpse into Game Theory

# Computability vs. Efficiency

- In the last part, we studied computability
  - When is it possible to guarantee consensus?
  - What kind of failures can be tolerated?
  - How many failures can be tolerated?

Worst-case scenarios!

- In this part, we consider practical solutions
  - Simple approaches that work well in practice
  - Focus on efficiency

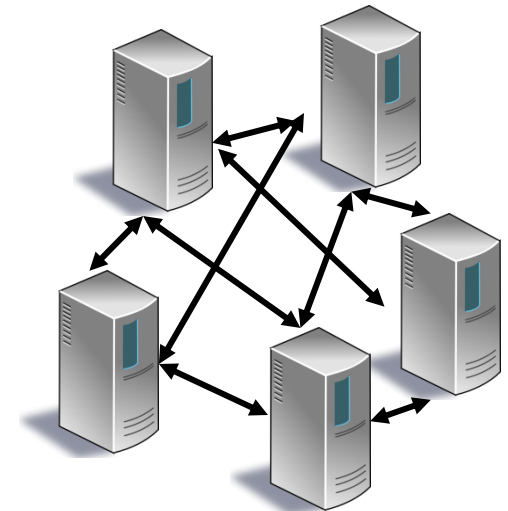
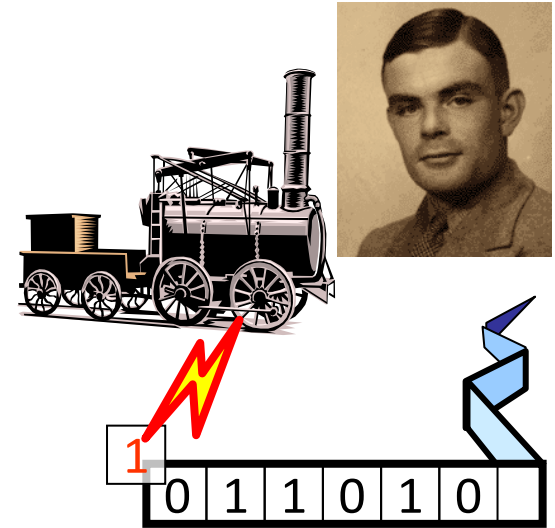

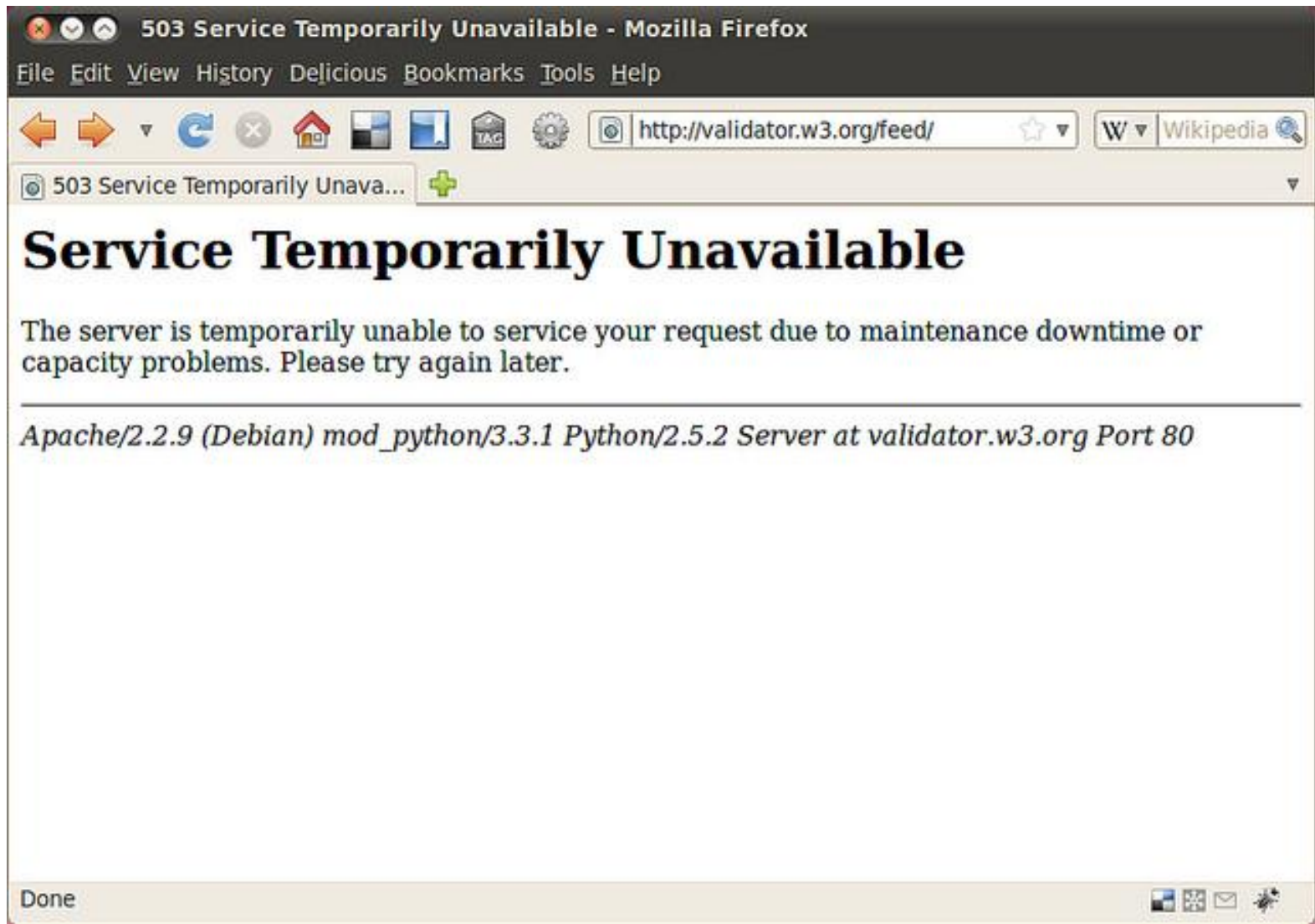

# Fault-Tolerance in Practice

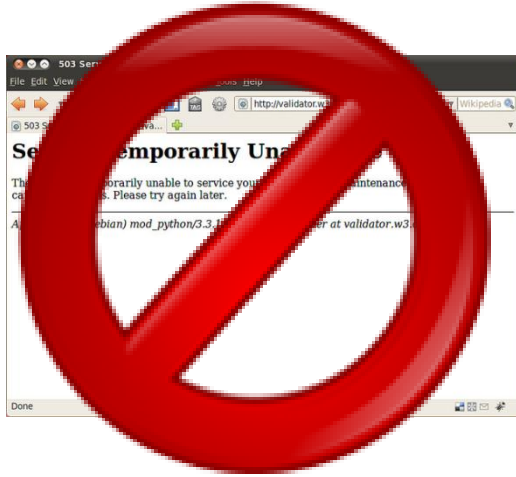

- Fault-Tolerance is achieved through *replication*

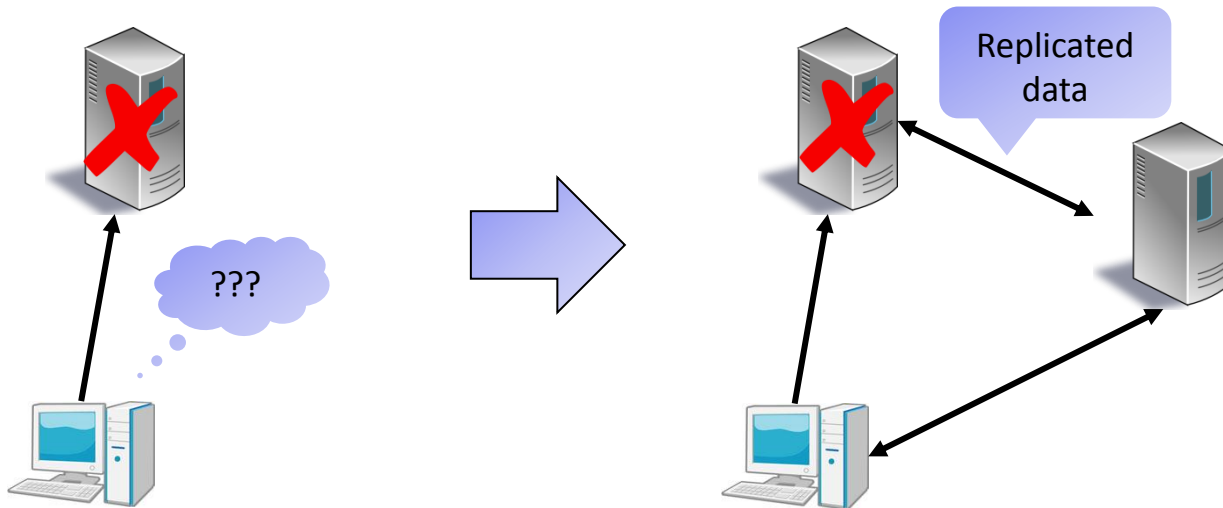

# Replication is Expensive

- Reading a value is simple → Just query any server
- Writing is more work → Inform all servers about the update
  - What if some servers are not available?

Read:

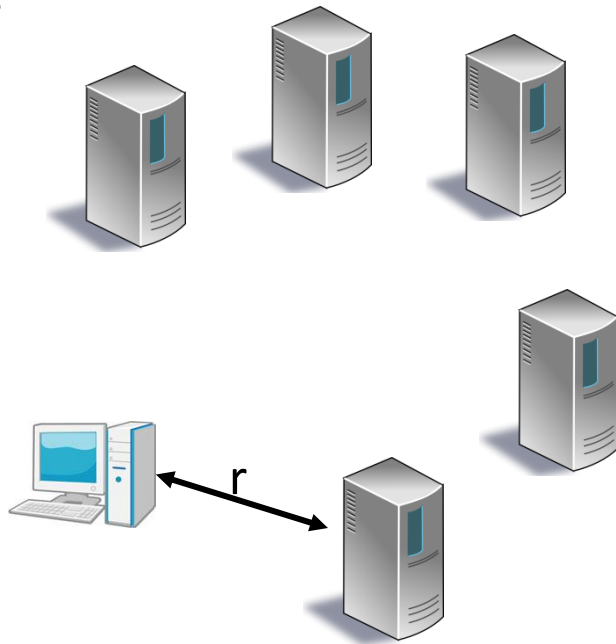

Write:

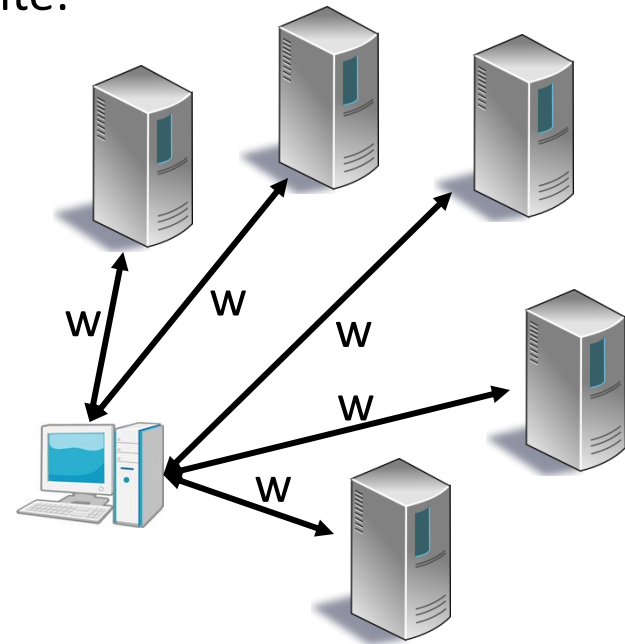

# Primary Copy

- Can we reduce the load on the clients?
- Yes! Write only to one server (the primary copy), and let primary copy distribute the update
  - This way, the client only sends one message in order to read and write

Read:

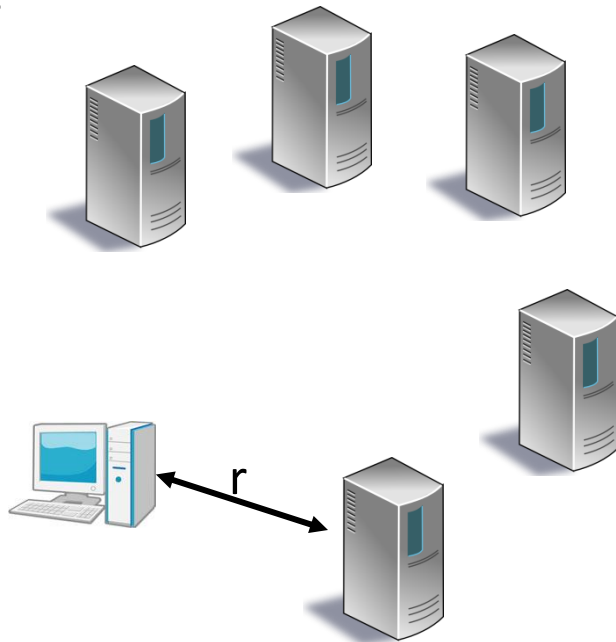

Write:

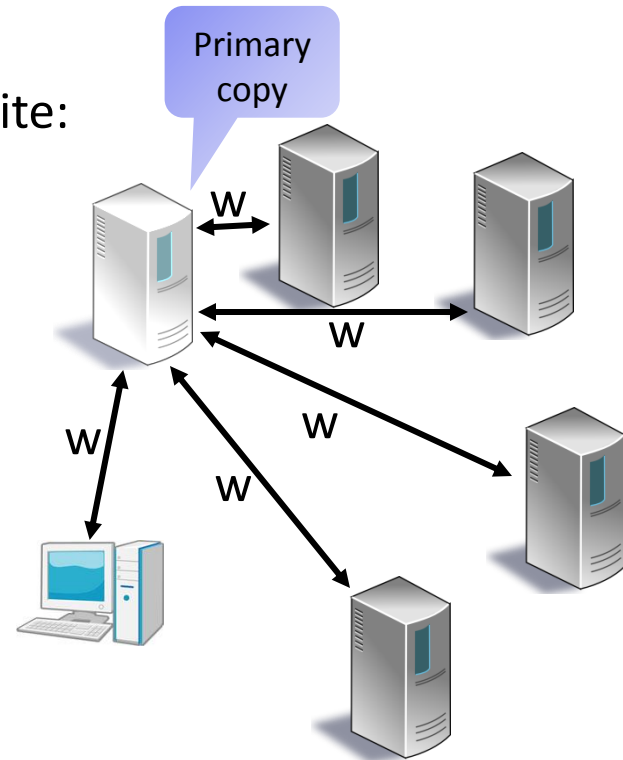

Zürich, Schweiz nach New York, New York, USA | Hinreise Di, 21. Dez 2010 Hinreise Jederzeit | Rückreise Fr, 21. Jan 2011 Hinreise Jederzeit | Reisende 1 | Optionen Direktflug, Economy Class

Bei den Preisen handelt es sich um den Gesamtpreis für alle Reisenden. Sie beinhalten Steuern und Gebühren.





	Rückreise Di, 18. Jan	Rückreise Mi, 19. Jan	Rückreise Do, 20. Jan	Rückreise Fr, 21. Jan	Rückreise Sa, 22. Jan	Rückreise So, 23. Jan	Rückreise Mo, 24. Jan
Hinreise Sa, 18. Dez	<u>CHF 918</u>	<u>CHF 970</u>	<u>CHF 970</u>	<u>CHF 970</u>	<u>CHF 970</u>	<u>CHF 970</u>	<u>CHF 970</u>
Hinreise So, 19. Dez	<u>CHF 698</u>	<u>CHF 698</u>	<u>CHF 750</u>	<u>CHF 750</u>	<u>CHF 750</u>	<u>CHF 750</u>	<u>CHF 750</u>
Hinreise Mo, 20. Dez	<u>CHF 646</u> Günstiger Preis	<u>CHF 646</u> Günstiger Preis	<u>CHF 646</u> Günstiger Preis	<u>CHF 750</u> Günstiger Preis			
Hinreise Di, 21. Dez	<u>CHF 646</u> Günstiger Preis	<u>CHF 646</u> Günstiger Preis	<u>CHF 646</u> Günstiger Preis	<u>CHF 646</u> Günstiger Preis			

**Consistency?**

ebookers.ch Willkommen bei ebookers.ch | Login | Register

Home Flüge Hotels Mietwagen Kombi-Reisen Angebote Badeferien Fragen

Ihre Suche: Hinreise Mo, 20. Dez 2010 Jederzeit | Zürich (ZRH) nach New York (NYC) | Rückreise Do, 20. Jan 2011 Jederzeit | New York (NYC) nach Zürich (ZRH)

	 American Airlines	 Continental Airlines	 Mehrere Airlines	 United Airlines	 SWISS
Direktflug	<u>CHF 1025</u>	<u>CHF 1311</u>	<u>CHF 1311</u>	<u>CHF 1346</u>	<u>CHF 3814</u>
Ein oder mehr Stopps					

Die Preise verstehen sich in Schweizer Franken Für alle Passagiere inkl. Flughafensteuern und Gebühren.



# Problem with Primary Copy

- If the clients can only send read requests to the primary copy, the system stalls if the primary copy fails
- However, if the clients can also send read requests to the other servers, the clients may not have a **consistent view**

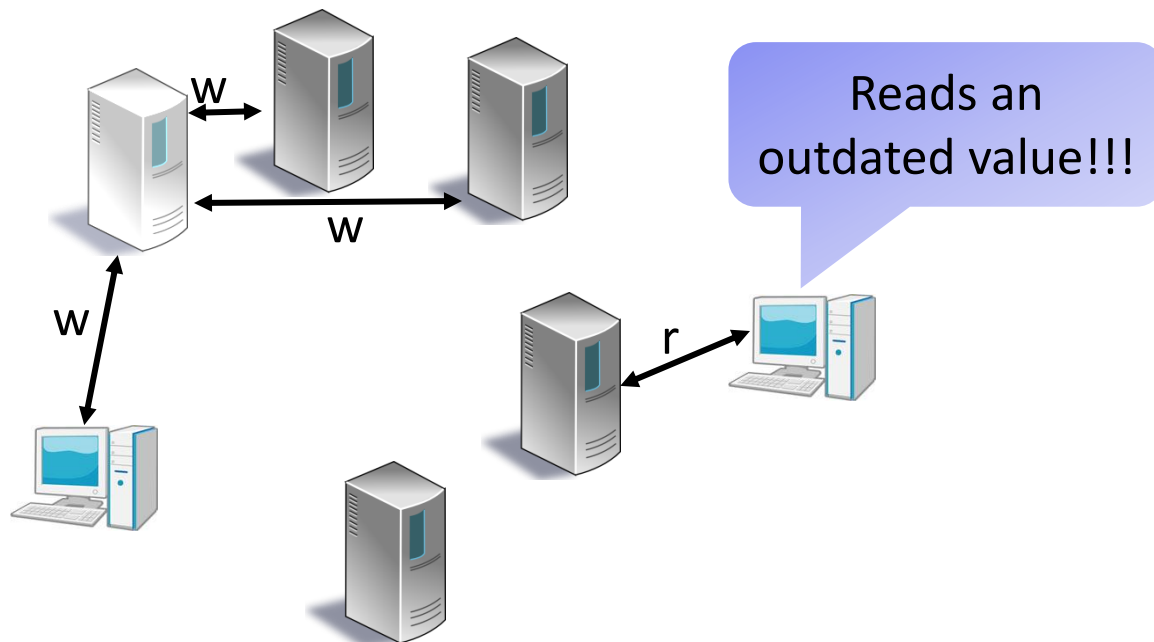

# State Machine Replication?

- The state of each server has to be updated in the same way
- This ensures that all servers are in the same state whenever all updates have been carried out!

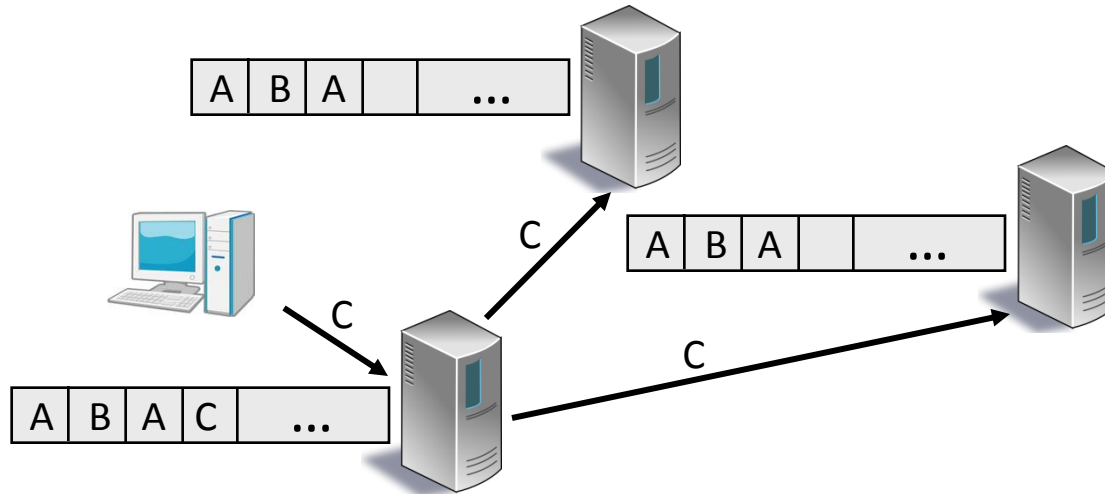

- The servers have to **agree on** each update  
→ **Consensus** has to be reached for each update!

## Theory

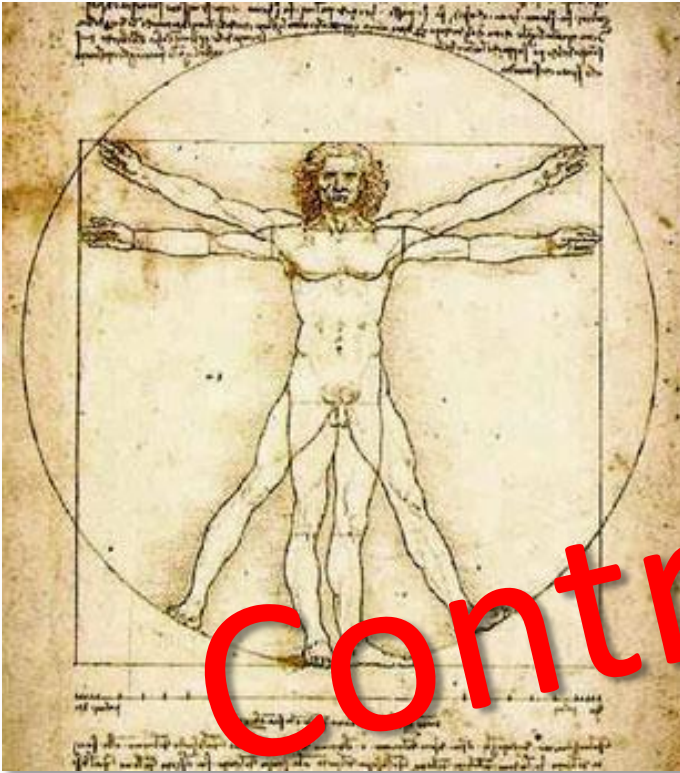

Impossible to guarantee consensus using a deterministic algorithm in asynchronous systems even if only one node is faulty

## Practice



Consensus is required to guarantee consistency among different replicas

Contradiction?

# From Theory to Practice

- So, how do we go from theory to practice...?
- Communication is often not synchronous, but not completely asynchronous either
  - There may be reasonable **bounds** on the **message delays**
  - Practical systems often use message passing. The machines **wait** for the response from another machine and abort/retry after **time-out**
  - Failures: It depends on the application/system what kind of failures have to be handled...
- That is...
  - Real-world protocols also make assumptions about the system
  - These assumptions allow us to circumvent the lower bounds!

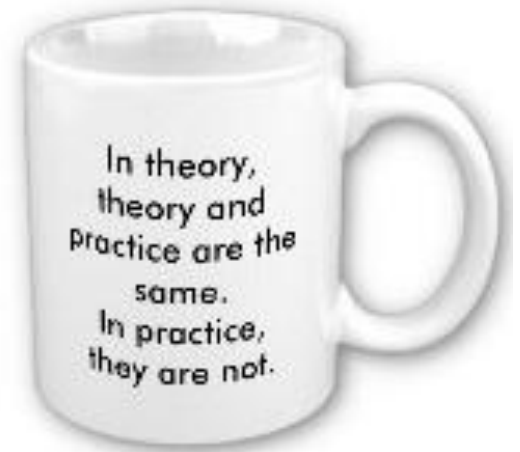

Depends on the bounds on the message delays!

# System

- Storage System

- Servers: 2...Millions
- Store data and react to client request

- Processes

- Clients, often millions
- Read and write/modify data

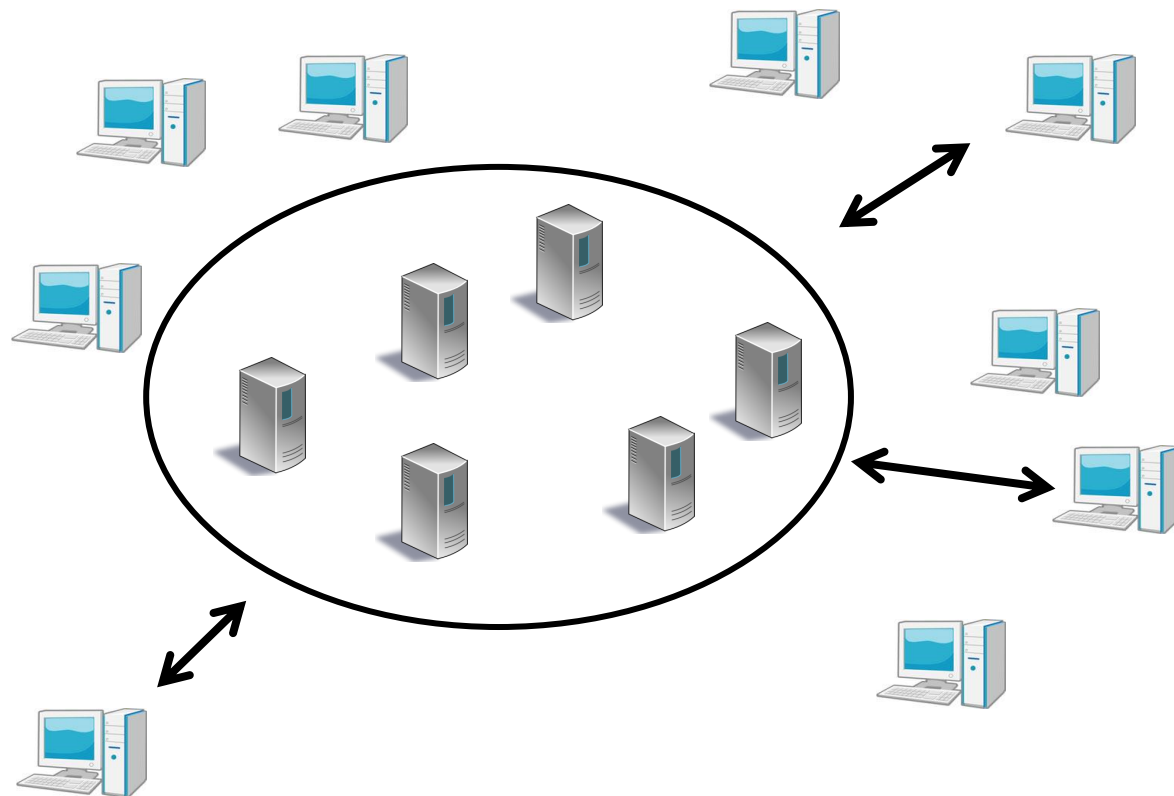

# Consistency Models (Client View)

- **Interface** that describes the system behavior (abstract away implementation details)
- If clients read/write data, they expect the behavior to be the same as for a single storage cell.

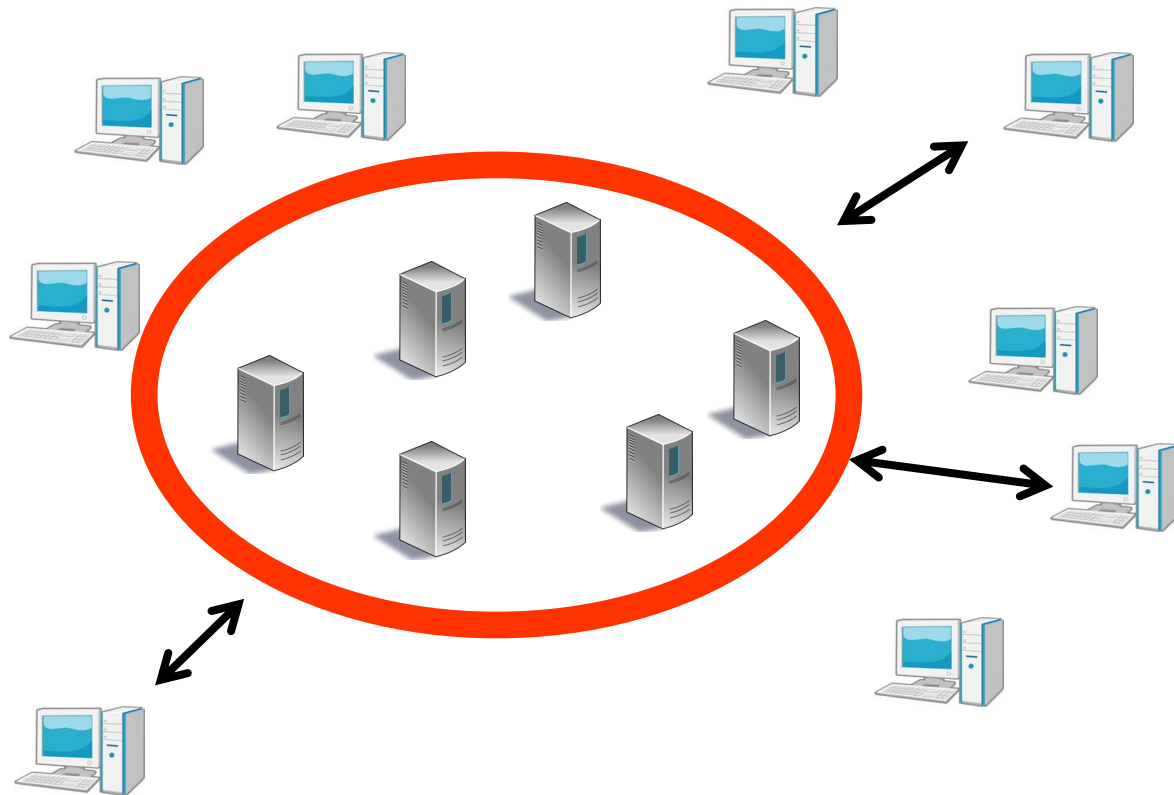

## Let's Formalize these Ideas

- We have memory that supports 3 types of operations:
  - $\text{write}(u := v)$ : write value  $v$  to the memory location at address  $u$
  - $\text{read}(u)$ : Read value stored at address  $u$  and return it
  - $\text{snapshot}()$ : return a map that contains all address-value pairs
- Each operation has a **start-time**  $T_S$  and **return-time**  $T_R$  (time it returns to the invoking client). The **duration** is given by  $T_R - T_S$ .

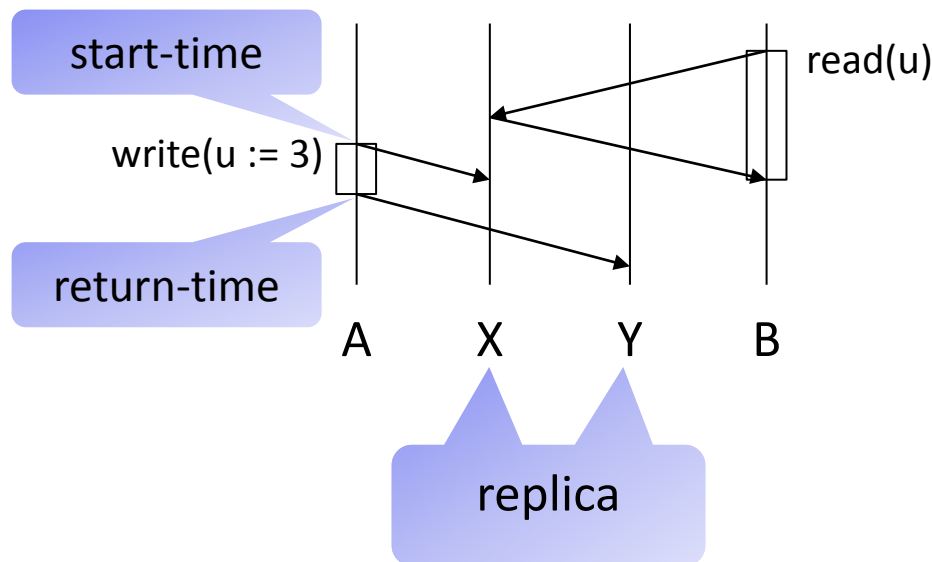

# Motivation

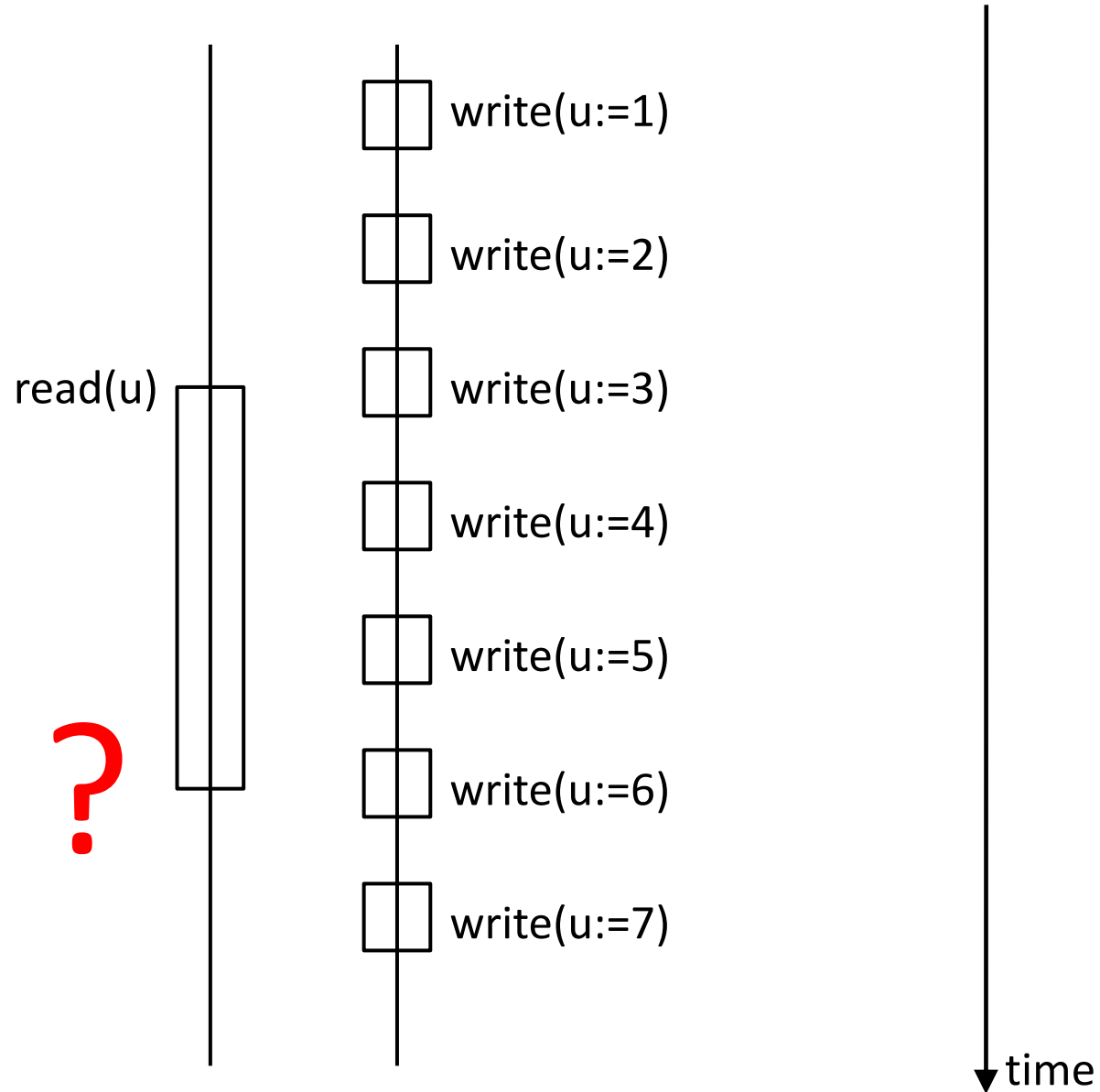



# Executions

- We look at **executions E** that define the (partial) order in which processes invoke operations.
- Real-time partial order of an execution  $<_r$ :
  - $p <_r q$  means that duration of operation  $p$  occurs entirely before duration of  $q$  (i.e.  $p$  returns before the invocation of  $q$  in **real time**).
- Client partial order  $<_c$ :
  - $p <_c q$  means  $p$  and  $q$  occur **at the same client**, and that  $p$  returns before  $q$  is invoked.

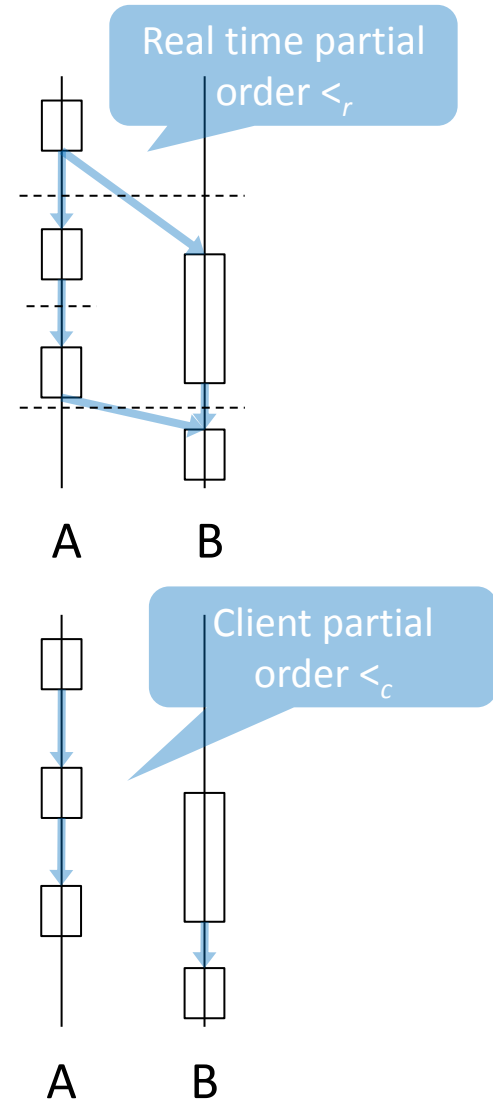

# Strong Consistency: Linearizability

- A replicated system is called linearizable if it behaves exactly as a single-site (unreplicated) system.

## Definition

Execution E is **linearizable** if there exists a sequence H such that:

- 1) H contains exactly the same operations as E, each paired with the return value received in E
- 2) The total order of operations in H is compatible with the real-time partial order  $<_r$
- 3) H is a legal history of the data type that is replicated

# Example: Linearizable Execution

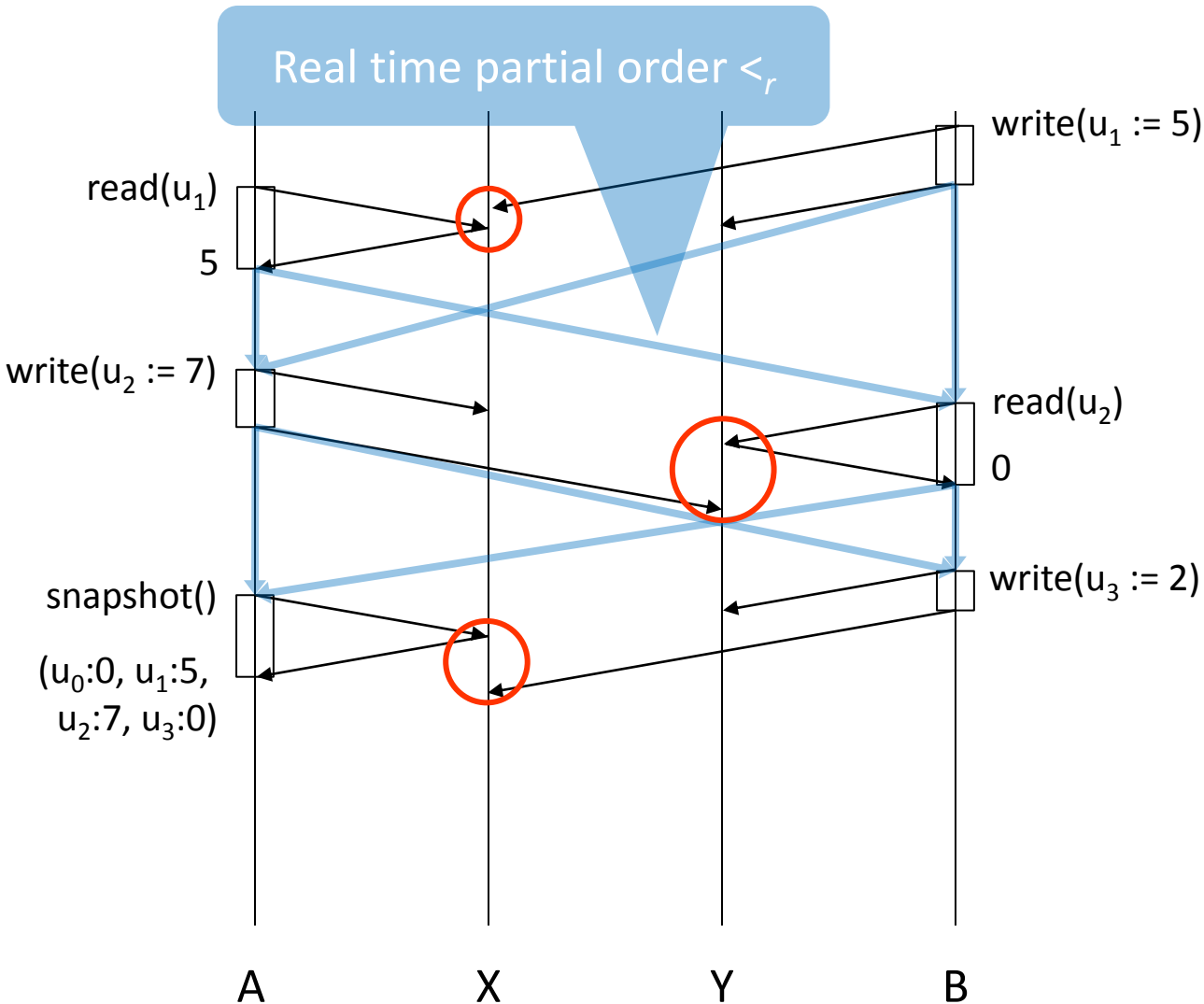

Valid sequence H:

- 1.) write( $u_1 := 5$ )
- 2.) read( $u_1$ )  $\rightarrow$  5
- 3.) read( $u_2$ )  $\rightarrow$  0
- 4.) write( $u_2 := 7$ )
- 5.) snapshot()  $\rightarrow$   
( $u_0: 0, u_1: 5, u_2:7, u_3:0$ )
- 6.) write( $u_3 := 2$ )

For this example, this is the only valid H. In general there might be several sequences H that fulfill all required properties.

# Strong Consistency: Sequential Consistency

- Orders at different locations are disregarded if it cannot be determined by any observer within the system.
- I.e., a system provides **sequential consistency** if every node of the system sees the (write) operations on the same memory address in the same order, although the order may be different from the order as defined by real time (as seen by a hypothetical external observer or global clock).

## Definition

Execution E is **sequentially consistent** if there exists a sequence H such that:

- 1) H contains exactly the same operations as E, each paired with the return value received in E
- 2) The total order of operations in H is compatible with the client partial order  $<_c$
- 3) H is a legal history of the data type that is replicated

# Example: Sequentially Consistent

Client partial order  $<_c$

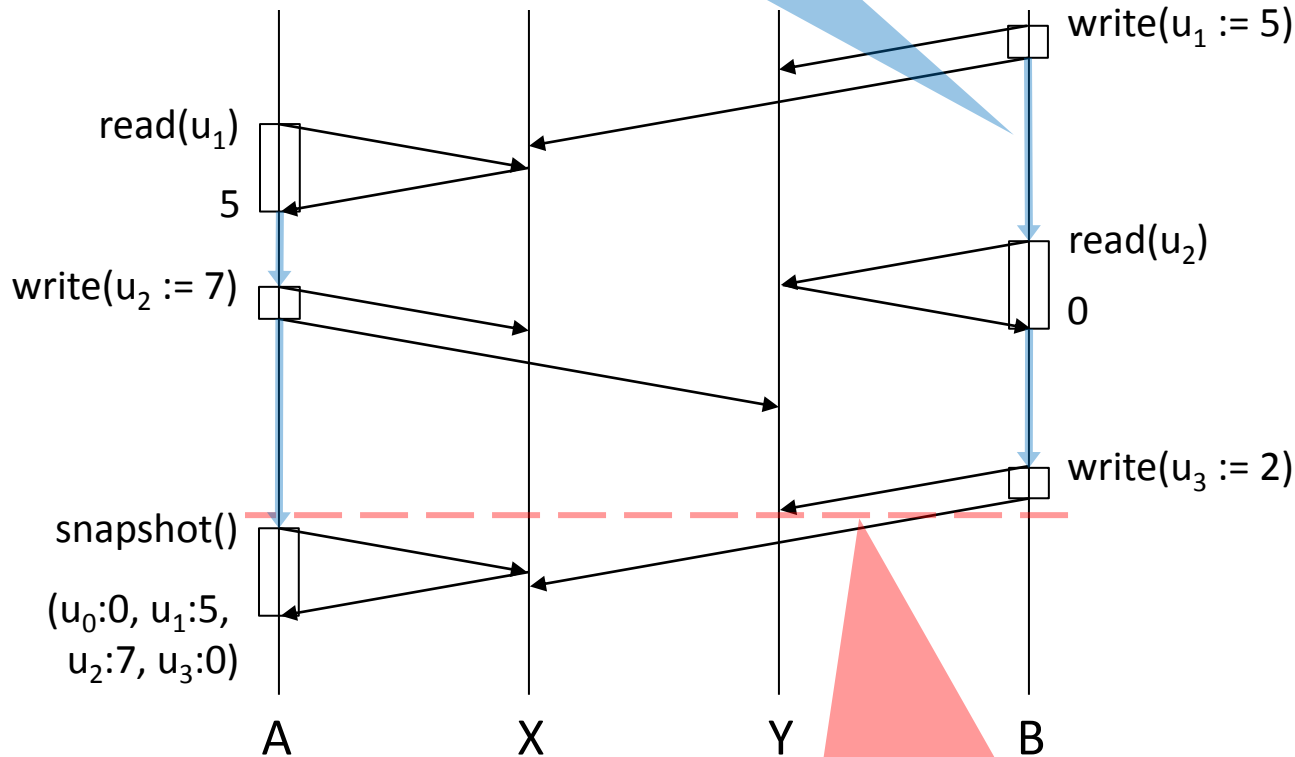

Valid sequence H:

- 1.) `write(u1 := 5)`
- 2.) `read(u1) → 5`
- 3.) `read(u2) → 0`
- 4.) `write(u2 := 7)`
- 5.) `snapshot() → (u0:0, u1:5, u2:7, u3:0)`
- 6.) `write(u3 := 2)`

Real-time partial order requires `write(3,2)` to be before `snapshot()`, which contradicts the view in `snapshot()`!

# Is Every Execution Sequentially Consistent?

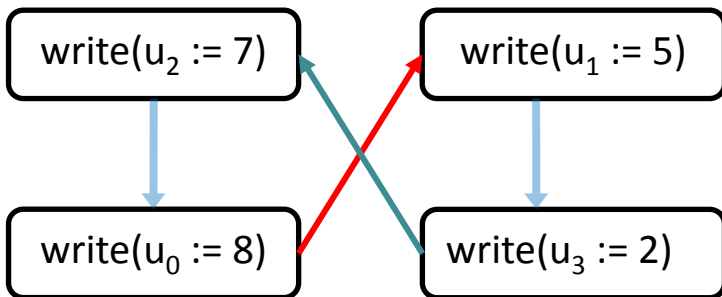
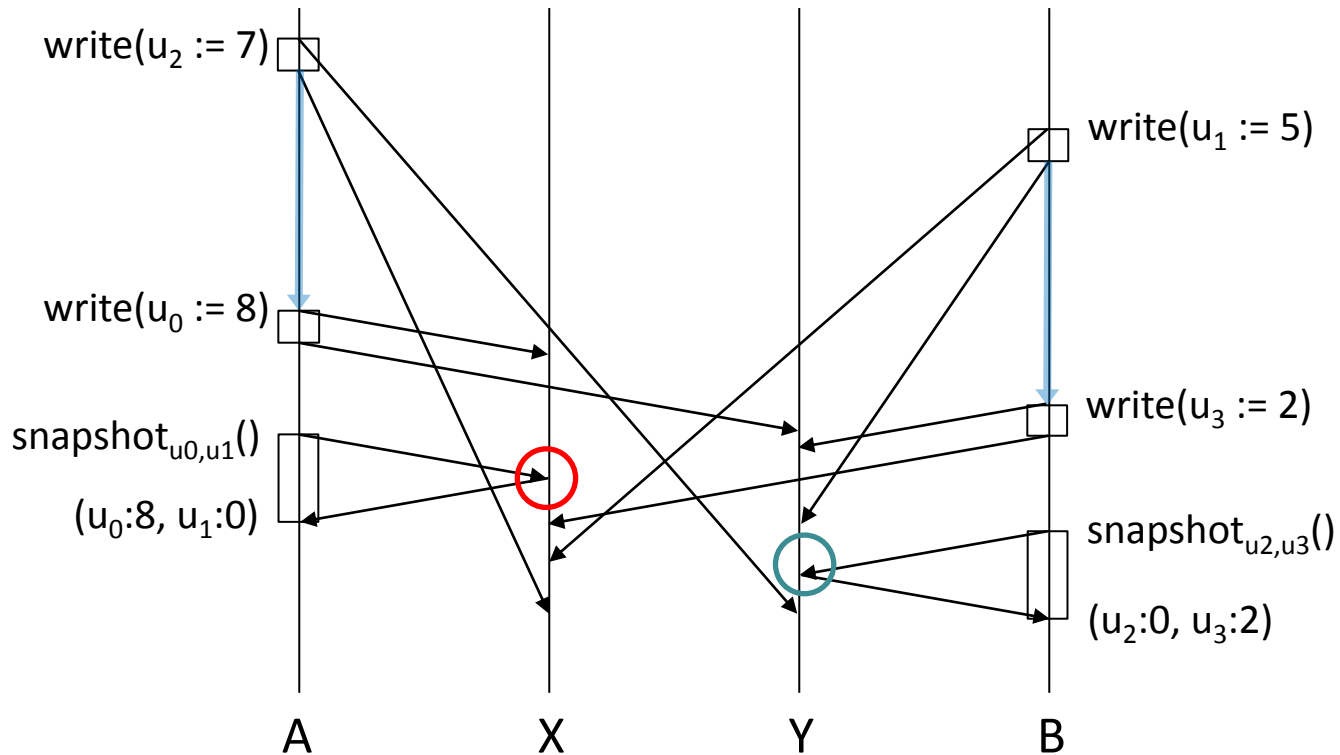

Circular dependencies!  
 I.e., there is no valid total order and thus above execution is not sequentially consistent

# Sequential Consistency does not Compose

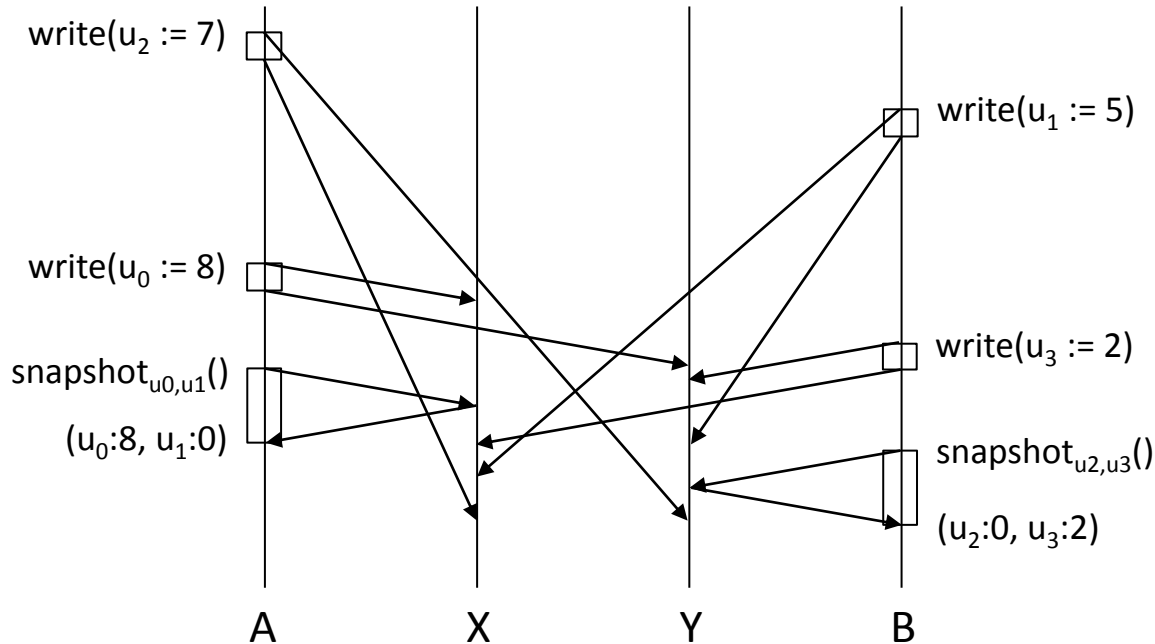

- If we only look at data items 0 and 1, operations are sequentially consistent
- If we only look at data items 2 and 3, operations are also sequentially consistent
- But, as we have seen before, the combination is not sequentially consistent

Sequential consistency does not compose!

(this is in contrast to linearizability)

# Transactions

- In order to achieve consistency, updates have to be **atomic**
- A write has to be an atomic transaction
  - Updates are synchronized
- Either all nodes (servers) **commit** a transaction or all **abort**
- How do we handle transactions in asynchronous systems?
  - Unpredictable messages delays!
- Moreover, any node may fail...
  - Recall that this problem cannot be solved in theory!

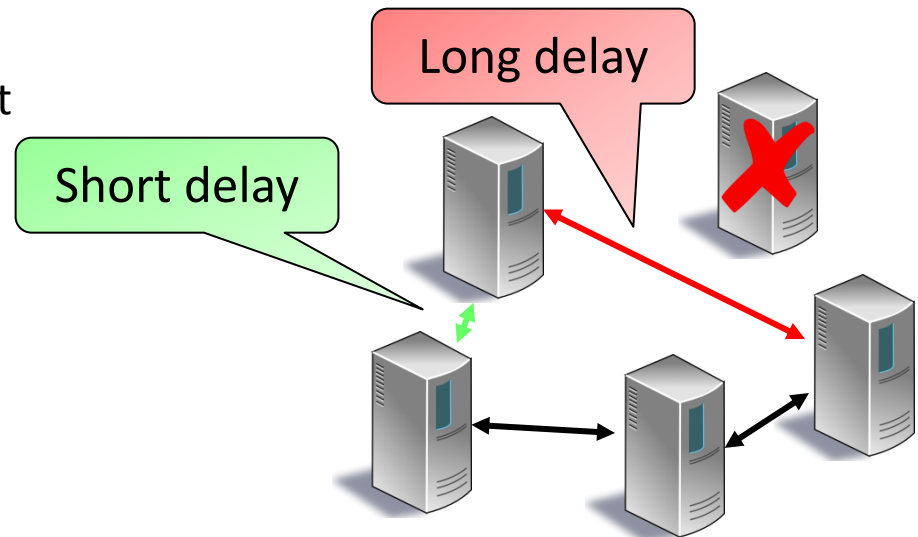



# Two-Phase Commit (2PC)

- A widely used protocol is the so-called two-phase commit protocol
- The idea is simple: There is a coordinator that coordinates the transaction
  - All other nodes communicate only with the coordinator
  - The coordinator communicates the final decision

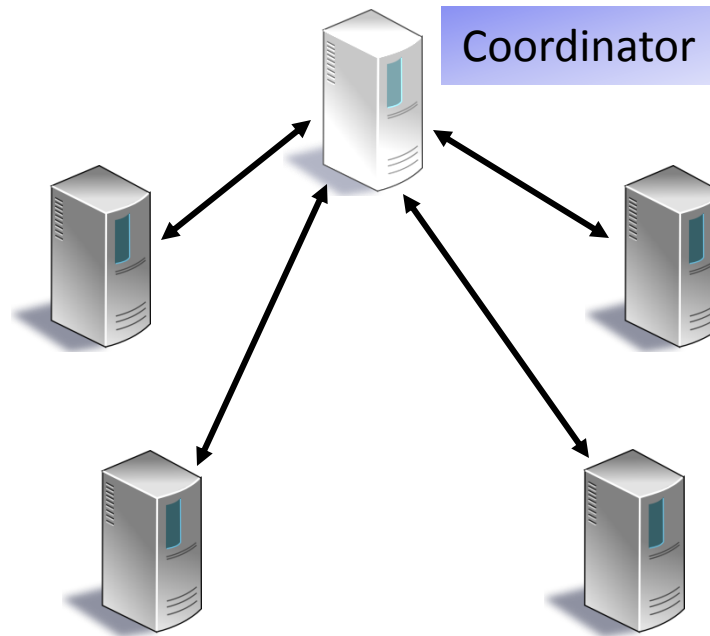

# Two-Phase Commit: Failures

- Fail-stop model: We assume that a failed node does not re-emerge
- Failures are detected (instantly)
  - E.g. time-outs are used in practical systems to detect failures
- If the coordinator fails, a new coordinator takes over (instantly)
  - How can this be accomplished reliably?

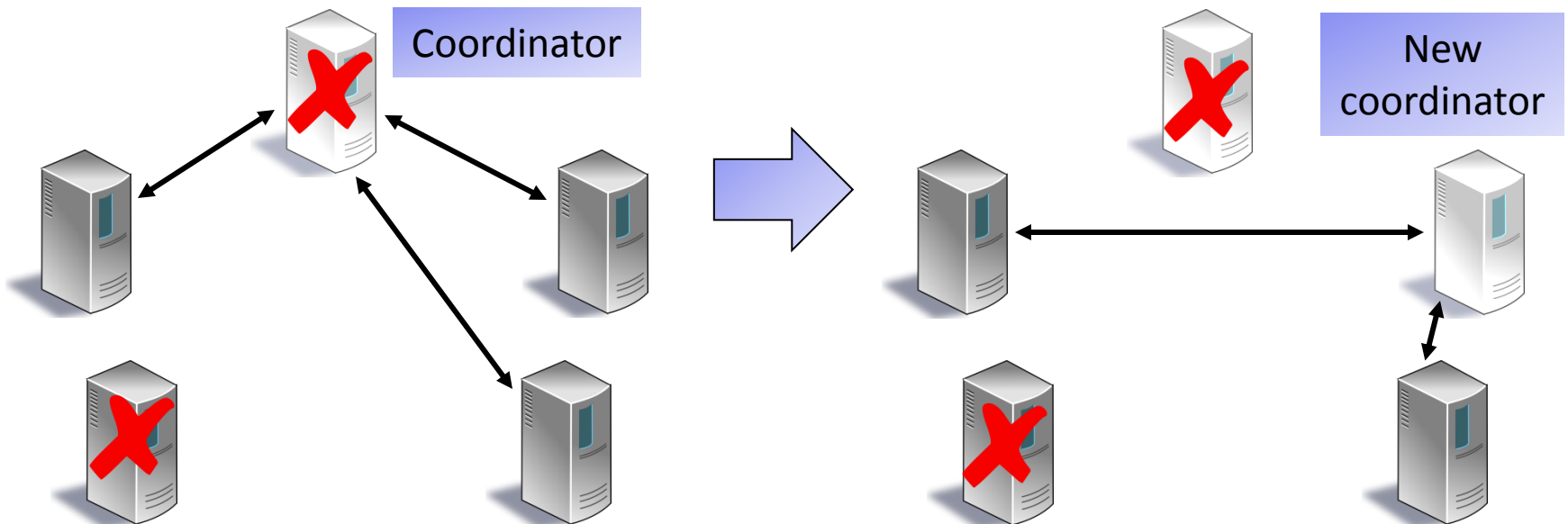

# Two-Phase Commit: Protocol

- In the first phase, the coordinator asks if all nodes are ready to commit
- In the second phase, the coordinator sends the decision (commit/abort)
  - The coordinator aborts if at least one node said **no**

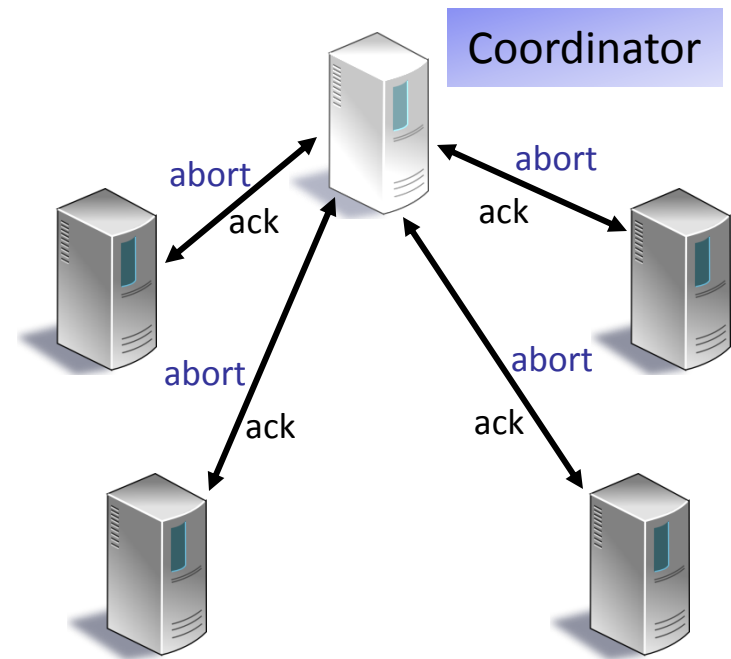
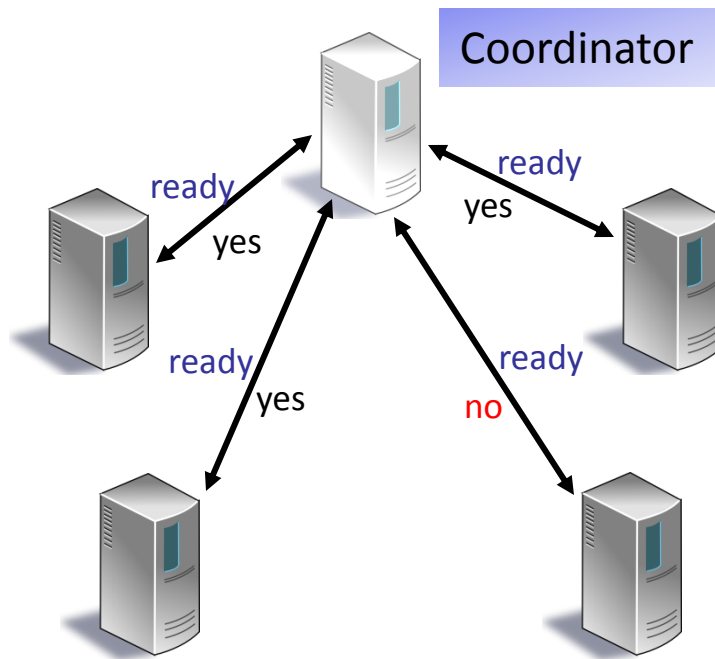

# Two-Phase Commit: Protocol

## Phase 1:

Coordinator sends *ready* to all nodes

If a node receives *ready* from the coordinator:

If it is ready to commit

    Send *yes* to coordinator

else

    Send *no* to coordinator

# Two-Phase Commit: Protocol

## Phase 2:

If the coordinator receives only *yes* messages:

    Send *commit* to all nodes

else

    Send *abort* to all nodes

If a node receives *commit* from the coordinator:

**Commit** the transaction

else                   (*abort* received)

**Abort** the transaction

Send *ack* to coordinator

Once the coordinator received all *ack* messages:

It completes the transaction by **committing** or **aborting** itself

# Two-Phase Commit: Analysis

- 2PC obviously works if there are no failures
- If a node that is not the coordinator fails, it still works
  - If the node fails before sending yes/no, the coordinator can either ignore it or safely abort the transaction
  - If the node fails before sending ack, the coordinator can still commit/abort depending on the vote in the first phase

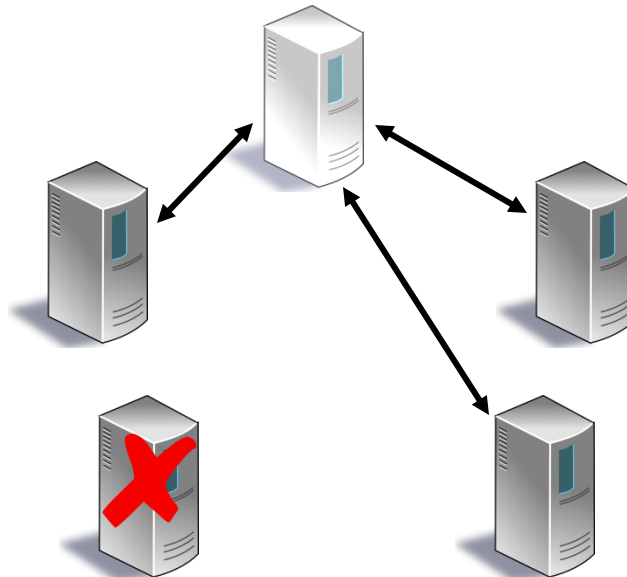

# Two-Phase Commit: Analysis

- What happens if the coordinator fails?
- As we said before, this is (somehow) detected and a new coordinator takes over
- How does the new coordinator proceed?
  - It must ask the other nodes if a node has already received a commit
  - A node that has received a commit replies yes, otherwise it sends no and promises not to accept a commit that may arrive from the old coordinator
  - If some node replied yes, the new coordinator broadcasts commit
- This works if there is only one failure
- Does 2PC still work with multiple failures...?

This safety mechanism is not a part of 2PC...

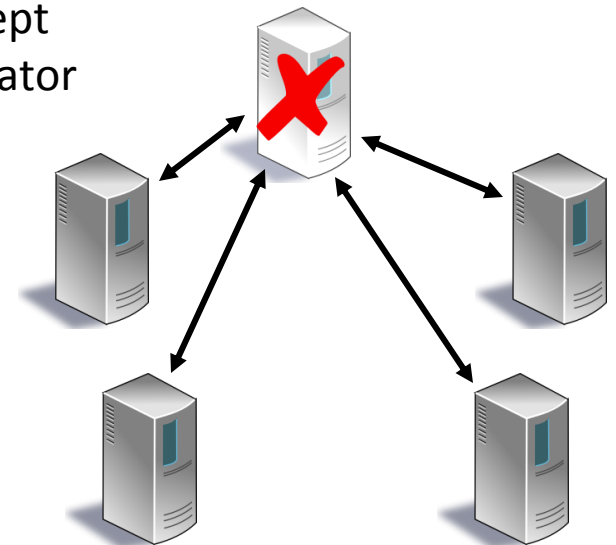

# Two-Phase Commit: Multiple Failures

- As long as the coordinator is alive, multiple failures are no problem
  - The same arguments as for one failure apply
- What if the coordinator and another node crashes?

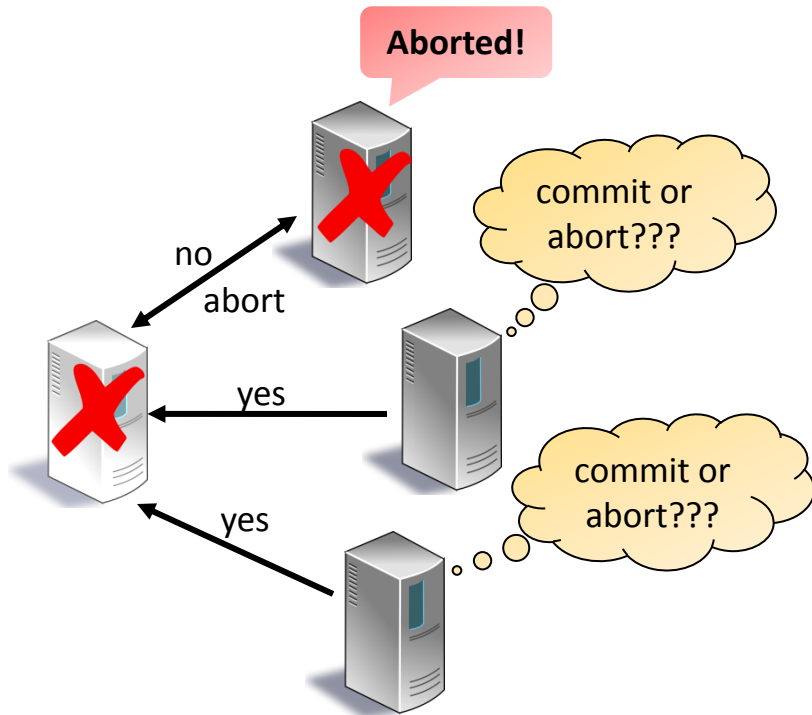

The nodes cannot commit!

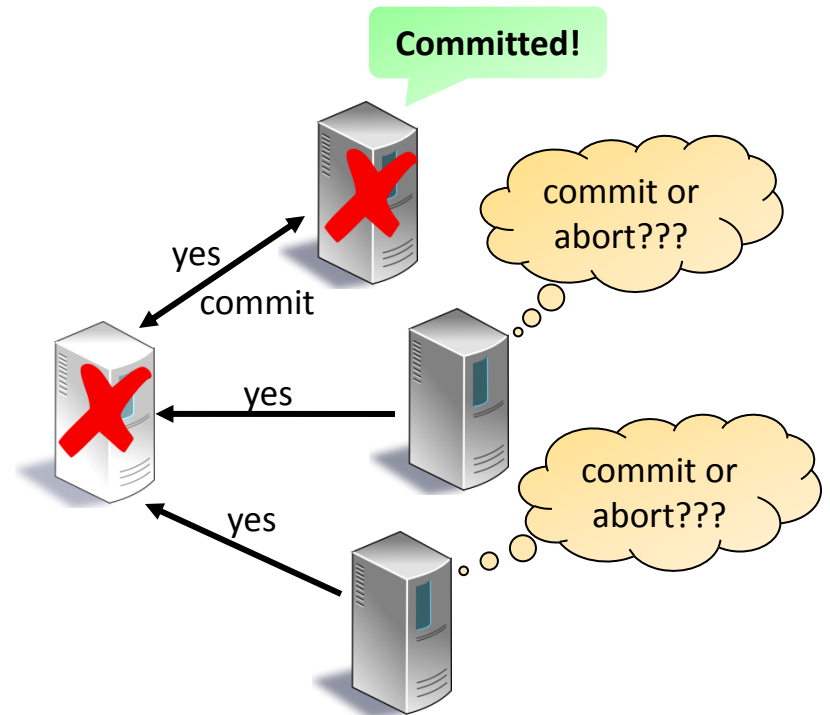

The nodes cannot abort!



# Two-Phase Commit: Multiple Failures

- What is the problem?
  - Some nodes may be ready to commit while others have already committed or aborted
  - If the coordinator crashes, the other nodes are not informed!
- How can we solve this problem?

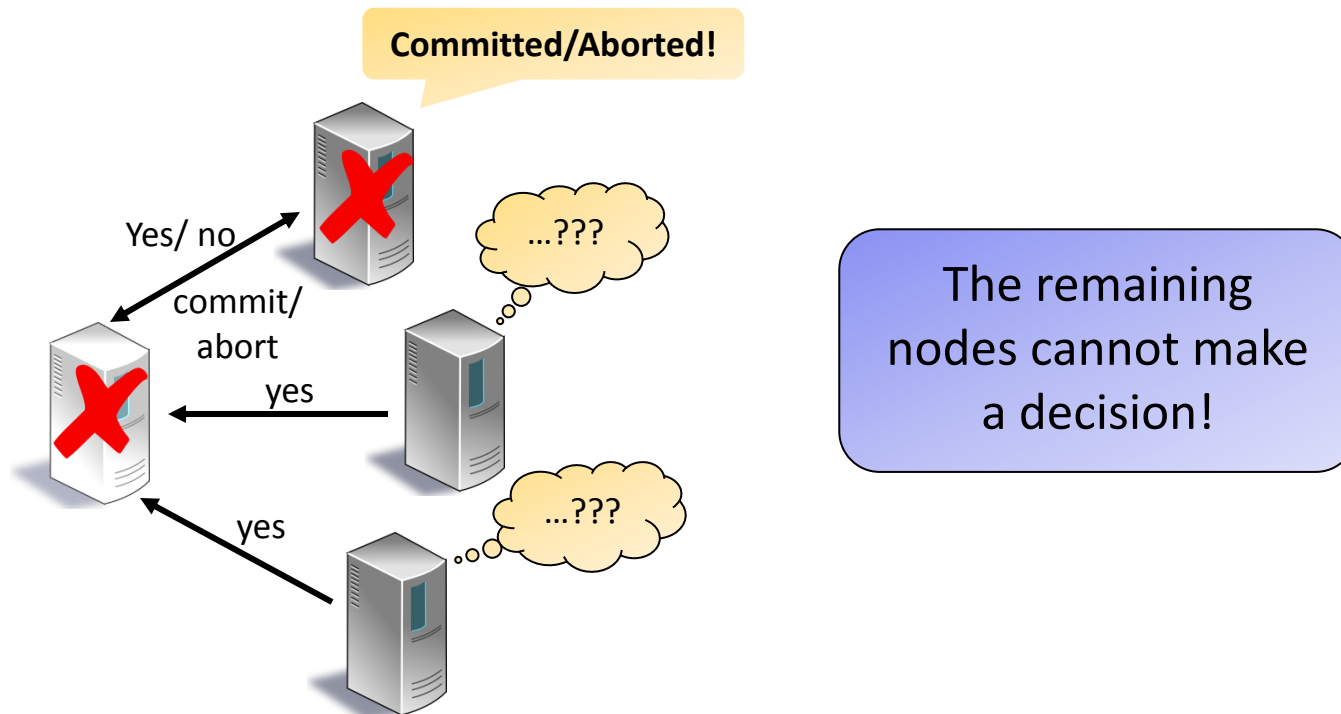

# Three-Phase Commit

- Solution: Add another phase to the protocol!
  - The new phase precedes the commit phase
  - The goal is to inform all nodes that all are ready to commit (or not)
  - At the end of this phase, every node knows whether or not all nodes want to commit *before* any node has actually committed or aborted!

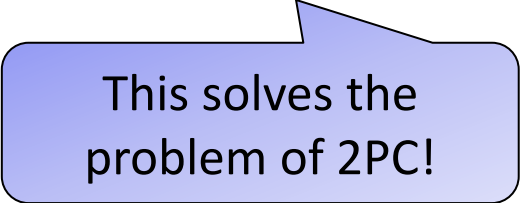

This solves the  
problem of 2PC!

- This protocol is called the three-phase commit (3PC) protocol

# Three-Phase Commit: Protocol

- In the new (second) phase, the coordinator sends prepare (to commit) messages to all nodes

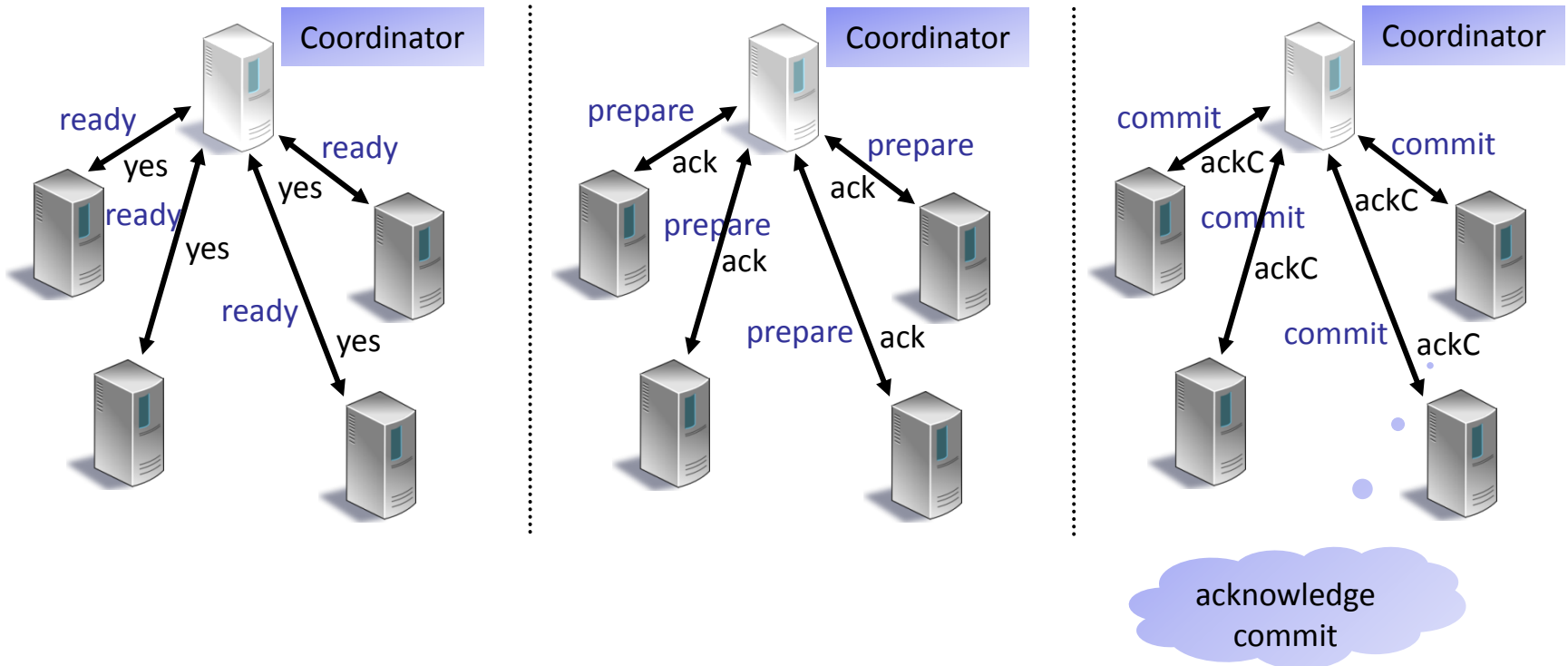

# Three-Phase Commit: Protocol

## Phase 1:

Coordinator sends *ready* to all nodes

If a node receives *ready* from the coordinator:

If it is ready to commit

Send *yes* to coordinator

else

Send *no* to coordinator

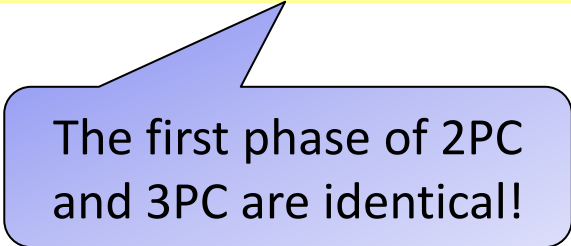

The first phase of 2PC  
and 3PC are identical!

# Three-Phase Commit: Protocol

## Phase 2:

If the coordinator receives only *yes* messages:

Send *prepare* to all nodes

else

Send *abort* to all nodes

If a node receives *prepare* from the coordinator:

Prepare to commit the transaction

else (*abort* received)

**Abort** the transaction

Send *ack* to coordinator



This is the new phase

# Three-Phase Commit: Protocol

## Phase 3:

Once the coordinator received all *ack* messages:

If the coordinator sent *abort* in Phase 2

    The coordinator **aborts** the transaction as well  
else           (it sent *prepare*)

    Send *commit* to all nodes

If a node receives *commit* from the coordinator:

**Commit** the transaction

Send *ackCommit* to coordinator

Once the coordinator received all *ackCommit* messages:

It completes the transaction by **committing** itself

# Three-Phase Commit: Analysis

- All non-faulty nodes either commit or abort
  - If the coordinator doesn't fail, 3PC is correct because the coordinator lets all nodes either commit or abort
  - Termination can also be guaranteed: If some node fails before sending *yes/no*, the coordinator can safely abort. If some node fails after the coordinator sent *prepare*, the coordinator can still enforce a commit because all nodes must have sent *yes*
  - If only the coordinator fails, we again don't have a problem because the new coordinator can restart the protocol
  - Assume that the coordinator and some other nodes failed and that some node committed. The coordinator must have received *ack* messages from all nodes → All nodes must have received a *prepare* message. The new coordinator can thus enforce a commit. If a node aborted, no node can have received a *prepare* message. Thus, the new coordinator can safely abort the transaction

# Three-Phase Commit: Analysis

- Although the 3PC protocol still works if multiple nodes fail, it still has severe shortcomings
  - 3PC still depends on a single coordinator. What if some but not all nodes assume that the coordinator failed?
    - The nodes first have to agree on whether the coordinator crashed or not!

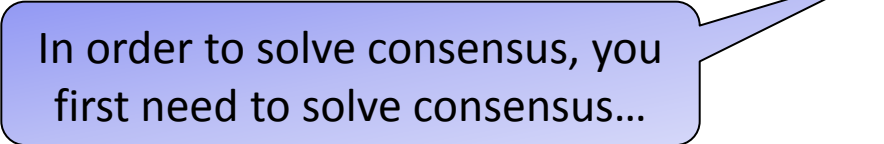

In order to solve consensus, you first need to solve consensus...

- Transient failures: What if a failed coordinator comes back to life? Suddenly, there is more than one coordinator!
- Still, 3PC and 2PC are used successfully in practice
- However, it would be nice to have a practical protocol that does not depend on a single coordinator
  - and that can handle temporary failures!



# Paxos

- Historical note
  - In the 1980s, a fault-tolerant distributed file system called “Echo” was built
  - According to the developers, it achieves “consensus” despite any number of failures as long as a majority of nodes is alive
  - The steps of the algorithm are simple if there are no failures and quite complicated if there are failures
  - Leslie Lamport thought that it is impossible to provide guarantees in this model and tried to prove it
  - Instead of finding a proof, he found a much simpler algorithm that works: The Paxos algorithm
- Paxos is an algorithm that does not rely on a coordinator
  - Communication is still asynchronous
  - All nodes may crash at any time and they may also recover



fail-recover model

# Paxos: Majority Sets

- Paxos is a two-phase protocol, but more resilient than 2PC
- Why is it more resilient?
  - There is no coordinator. A majority of the nodes is asked if a certain value can be accepted
  - A majority set is enough because the intersection of two majority sets is not empty → If a majority chooses one value, no majority can choose another value!

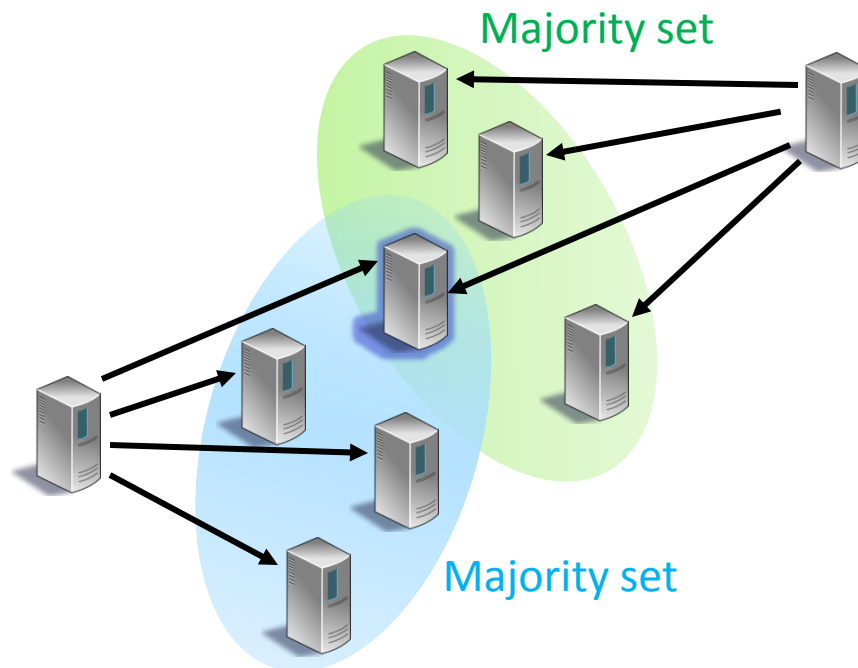

# Paxos: Majority Sets

- Majority sets are a good idea
- But, what happens if several nodes compete for a majority?
  - Conflicts have to be resolved
  - Some nodes may have to change their decision

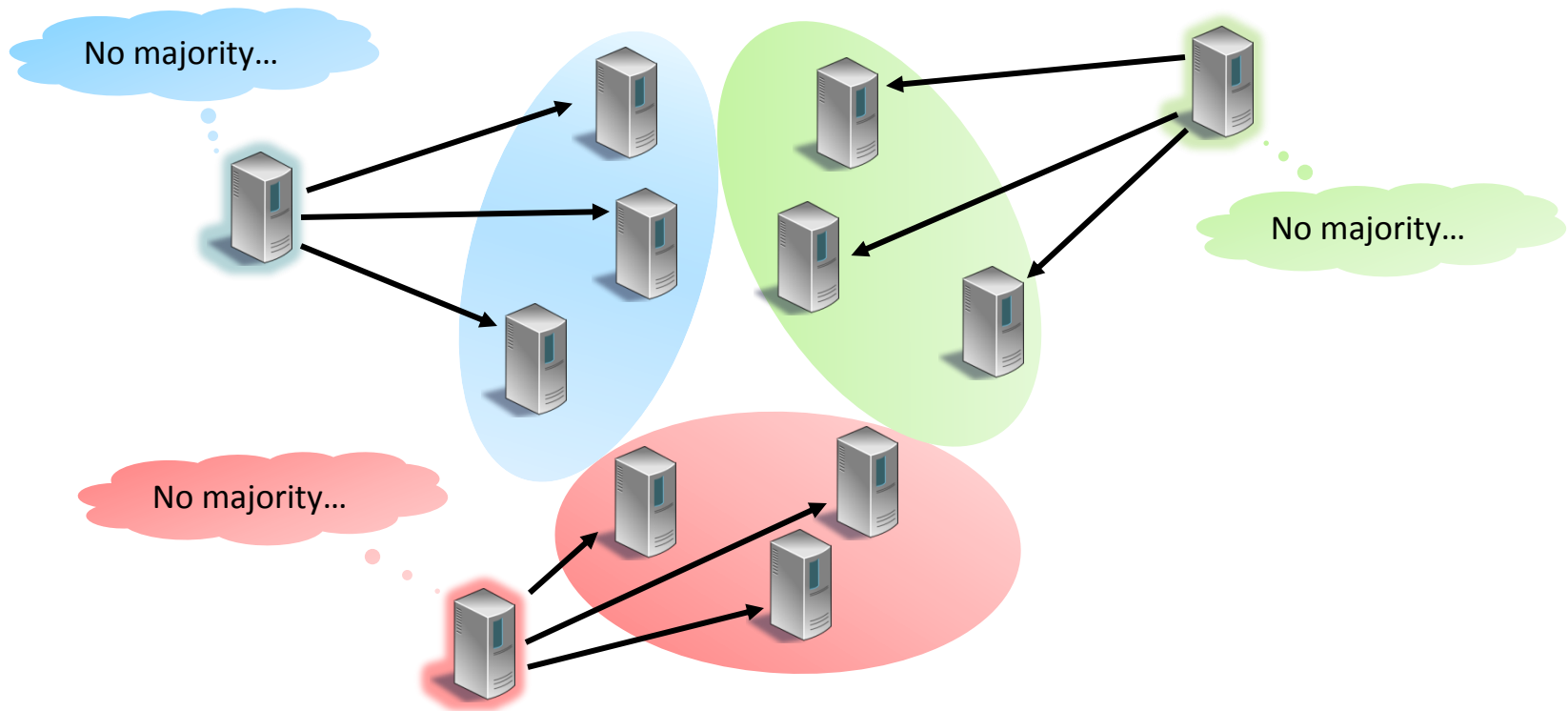

# Paxos: Roles



There are three roles

- Each node has one or more roles:
- Proposer
  - A proposer is a node that proposes a certain value for acceptance
  - Of course, there can be any number of proposers at the same time
- Acceptor
  - An acceptor is a node that receives a proposal from a proposer
  - An acceptor can either accept or reject a proposal
- Learner
  - A learner is a node that is not involved in the decision process
  - The learners must learn the final result from the proposers/acceptors

# Paxos: Proposal

- A proposal  $(x,n)$  consists of the proposed value  $x$  and a proposal number  $n$
- Whenever a proposer issues a new proposal, it chooses a larger (unique) proposal number
- An acceptor *accepts* a proposal  $(x,n)$  if  $n$  is larger than any proposal number it has ever heard

Give preference to larger proposal numbers!

- An acceptor can *accept* any number of proposals
  - An accepted proposal may not necessarily be *chosen*
  - The value of a *chosen proposal* is the *chosen value*
- An acceptor can even *choose* any number of proposals
  - However, if two proposals  $(x,n)$  and  $(y,m)$  are chosen, then  $x = y$

Consensus: Only one value can be chosen!

# Paxos: Prepare

- Before a node sends  $\text{propose}(x,n)$ , it sends  $\text{prepare}(x,n)$ 
  - This message is used to indicate that the node wants to propose  $(x,n)$
- If  $n$  is larger than all received request numbers, an acceptor returns the *accepted* proposal  $(y,m)$  with the largest request number  $m$ 
  - If it never accepted a proposal, the acceptor returns  $(\emptyset,0)$
  - The proposer learns about accepted proposals!

Note that  $m < n!$



This is the first phase!

# Paxos: Propose

- If the proposer receives all replies, it sends a proposal
- However, it only proposes its own value, if it only received  $\text{acc}(\emptyset, 0)$ , otherwise it adopts the value  $y$  in the proposal with the largest request number  $m$ 
  - The proposal still contains its sequence number  $n$ , i.e.,  $(y, n)$  is proposed
- If the proposer receives all acknowledgements  $\text{ack}(y, n)$ , the proposal is *chosen*

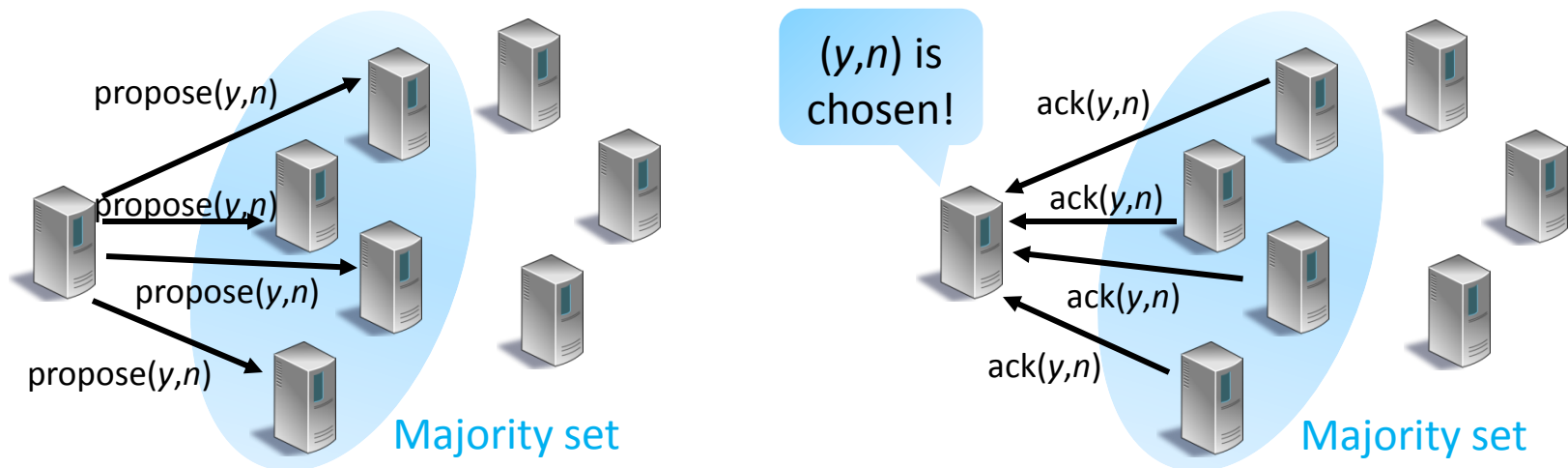

This is the second phase!

# Paxos: Algorithm of Proposer

Proposer wants to propose  $(x,n)$ :

Send  $\text{prepare}(x,n)$  to a majority of the nodes

if a majority of the nodes replies then

Let  $(y,m)$  be the received proposal with the largest request number

if  $m = 0$  then (No acceptor ever accepted another proposal)

Send  $\text{propose}(x,n)$  to the same set of acceptors

else

Send  $\text{propose}(y,n)$  to the same set of acceptors

if a majority of the nodes replies with  $\text{ack}(x,n)$  respectively  $\text{ack}(y,n)$

The proposal is chosen!

The value of the proposal  
is also chosen!

After a time-out, the proposer gives  
up and may send a new proposal



# Paxos: Algorithm of Acceptor

Why persistently?

Initialize and store persistently:

$n_{\max} := 0$

Largest request number ever received

$(x_{\text{last}}, n_{\text{last}}) := (\emptyset, 0)$

Last accepted proposal

Acceptor receives prepare  $(x, n)$ :

if  $n > n_{\max}$  then

$n_{\max} := n$

Send  $\text{acc}(x_{\text{last}}, n_{\text{last}})$  to the proposer

Acceptor receives proposal  $(x, n)$ :

if  $n = n_{\max}$  then

$x_{\text{last}} := x$

$n_{\text{last}} := n$

Send  $\text{ack}(x, n)$  to the proposer

# Paxos: Spreading the Decision

- After a proposal is chosen, only the proposer knows about it!
- How do the others (learners) get informed?
- The proposer could inform all learners directly
  - Only  $n-1$  messages are required
  - If the proposer fails, the learners are not informed (directly)...
- The acceptors could broadcast every time they accept a proposal
  - Much more fault-tolerant
  - Many accepted proposals may not be chosen...
  - Moreover, choosing a value costs  $O(n^2)$  messages without failures!
- Something in the middle?
  - The proposer informs  $b$  nodes and lets them broadcast the decision

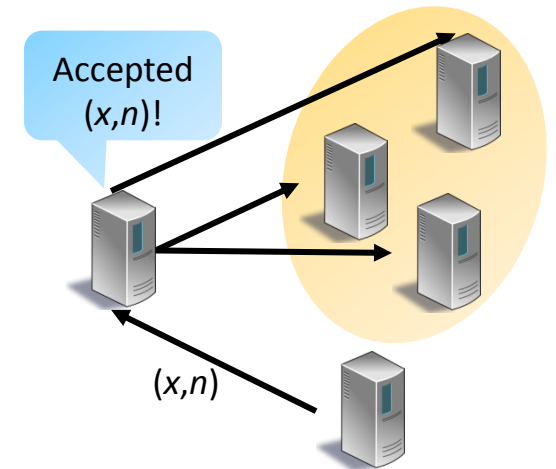
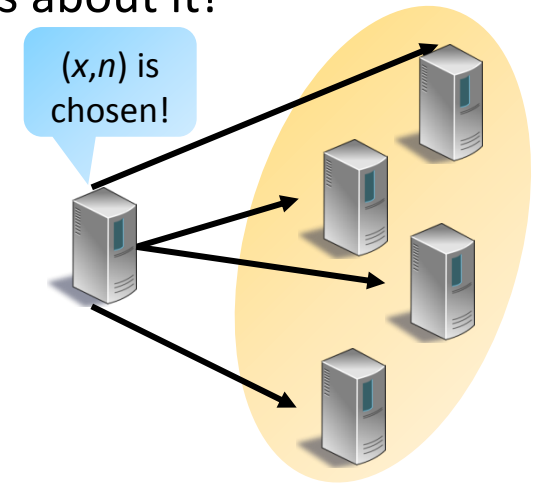

Trade-off: fault-tolerance vs. message complexity

# Paxos: Agreement

## Lemma

If a proposal  $(x,n)$  is *chosen*, then for every issued proposal  $(y,n')$  for which  $n' > n$  it holds that  $x = y$

## Proof:

- Assume that there are proposals  $(y,n')$  for which  $n' > n$  and  $x \neq y$ . Consider the proposal with the smallest proposal number  $n'$
- Consider the non-empty intersection  $S$  of the two sets of nodes that function as the acceptors for the two proposals
- Proposal  $(x,n)$  has been accepted  $\rightarrow$  Since  $n' > n$ , the nodes in  $S$  must have received  $\text{prepare}(y,n')$  after  $(x,n)$  has been accepted
- This implies that the proposer of  $(y,n')$  would also propose the value  $x$  unless another acceptor has accepted a proposal  $(z,n^*)$ ,  $z \neq x$  and  $n < n^* < n'$ . However, this means that some node must have proposed  $(z,n^*)$ , a contradiction because  $n^* < n'$  and we said that  $n'$  is the smallest proposal number!

# Paxos: Theorem

Theorem

If a value is chosen, all nodes choose this value

## Proof:

- Once a proposal  $(x, n)$  is chosen, each proposal  $(y, n')$  that is sent afterwards has the same proposal value, i.e.,  $x = y$  according to the lemma on the previous slide
- Since every subsequent proposal has the same value  $x$ , every proposal that is accepted after  $(x, n)$  has been chosen has the same value  $x$
- Since no other value than  $x$  is accepted, no other value can be chosen!

# Paxos: Wait a Minute...

- Paxos is great!
- It is a simple, **deterministic** algorithm that works in **asynchronous** systems and tolerates  $f < n/2$  failures
- Is this really possible...?



Theorem

A deterministic algorithm cannot guarantee consensus in asynchronous systems even if there is just one faulty node



- Does Paxos contradict this lower bound...?

# Paxos: No Liveness Guarantee

- The answer is no! Paxos only guarantees that if a value is chosen, the other nodes can only choose the same value
- It does not guarantee that a value is chosen!

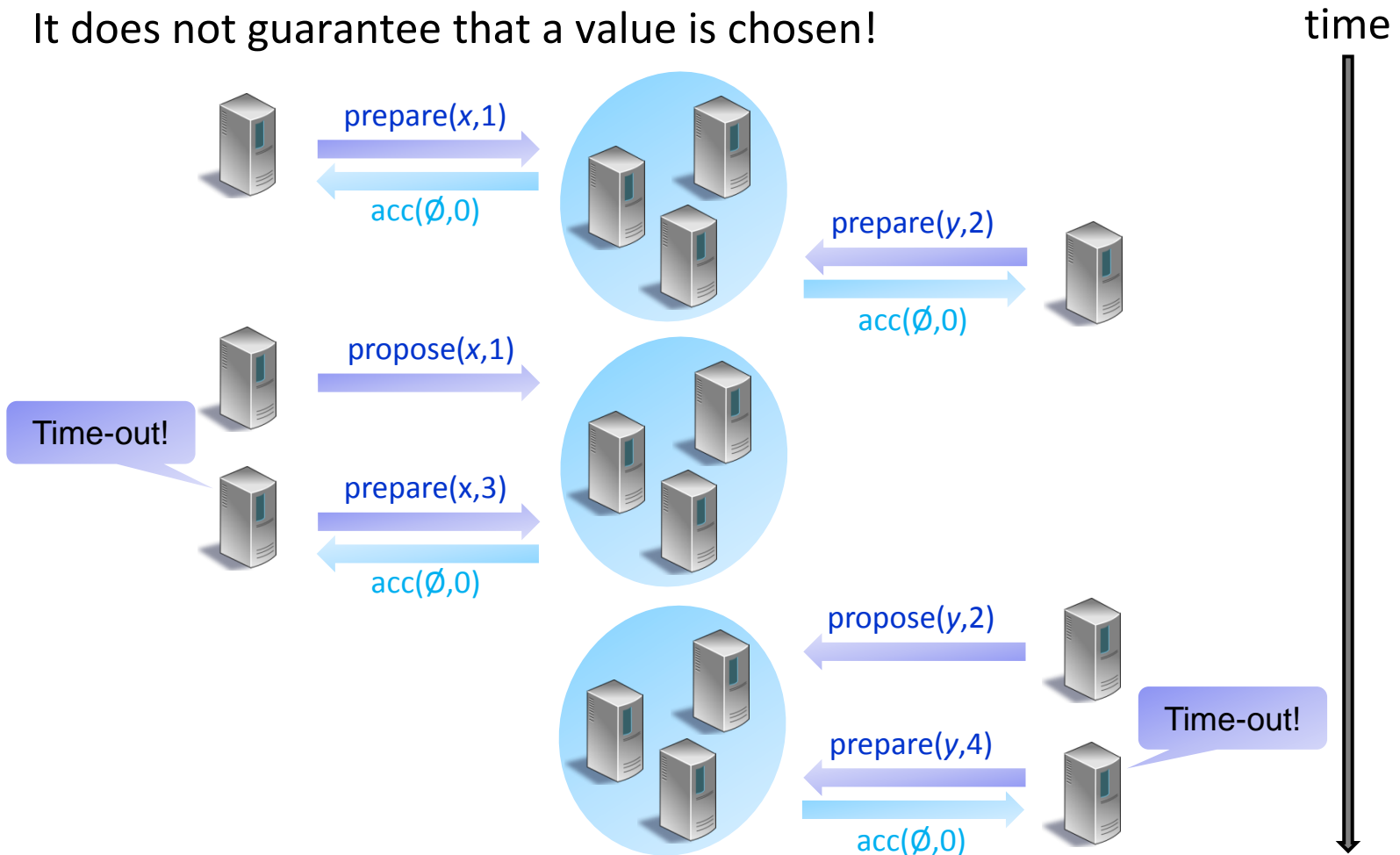

# Paxos: Agreement vs. Termination

- In asynchronous systems, a deterministic consensus algorithm cannot have both, guaranteed **termination** and **correctness**
- Paxos is always correct. Consequently, it cannot guarantee that the protocol terminates in a certain number of rounds

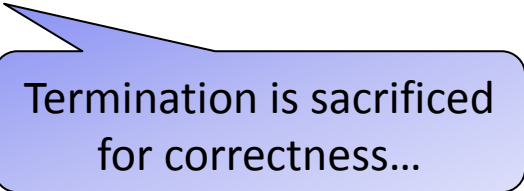

Termination is sacrificed  
for correctness...

- Although Paxos may not terminate in theory, it is quite efficient in practice using a few optimizations . . .

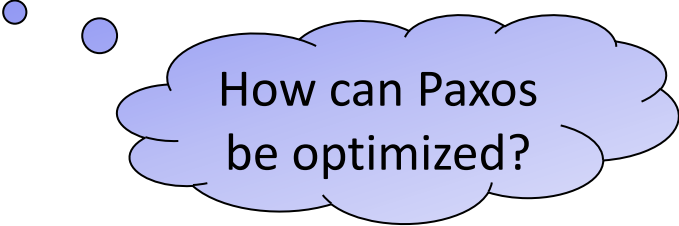

How can Paxos  
be optimized?

# Paxos in Practice

- There are ways to optimize Paxos by dealing with some practical issues
  - For example, the nodes may wait for a long time until they decide to try to submit a new proposal
  - A simple solution: The acceptors send NAK if they do not accept a prepare message or a proposal. A node can then abort immediately
  - Note that this optimization increases the message complexity...
- Paxos is indeed used in practical systems!
  - Yahoo!'s *ZooKeeper*: A management service for large distributed systems uses a variation of Paxos to achieve consensus
  - Google's *Chubby*: A distributed lock service library. Chubby stores lock information in a replicated database to achieve high availability. The database is implemented on top of a fault-tolerant log layer based on Paxos



# Paxos: Fun Facts

- Why is the algorithm called Paxos?
- Leslie Lamport described the algorithm as the solution to a problem of the parliament on a fictitious Greek island called Paxos
- Many readers were so distracted by the description of the activities of the legislators, they did not understand the meaning and purpose of the algorithm. The paper was rejected
- Leslie Lamport refused to rewrite the paper. He later wrote that he *“was quite annoyed at how humorless everyone working in the field seemed to be”*
- After a few years, some people started to understand the importance of the algorithm
- After eight years, Leslie Lamport submitted the paper again, basically unaltered. It got accepted!



# Quorum

Paxos used Majority sets: Can this be generalized?

Yes: It`s called Quorum



- In law, a **quorum** is a the minimum number of members of a deliberative body necessary to conduct the business of the group.
- In our case: substitute “members of a deliberative body” with “any subset of servers of a distributed system”

A Quorum does not automatically need to be a majority.

What else can you imagine? What are reasonable objectives?

# Quorum: Primary Copy vs. Majority

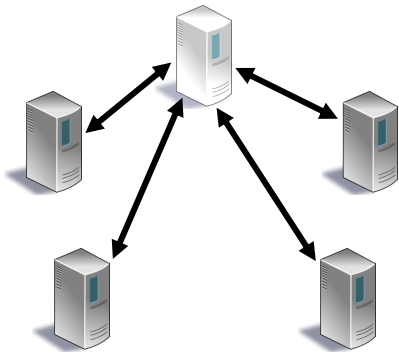

or

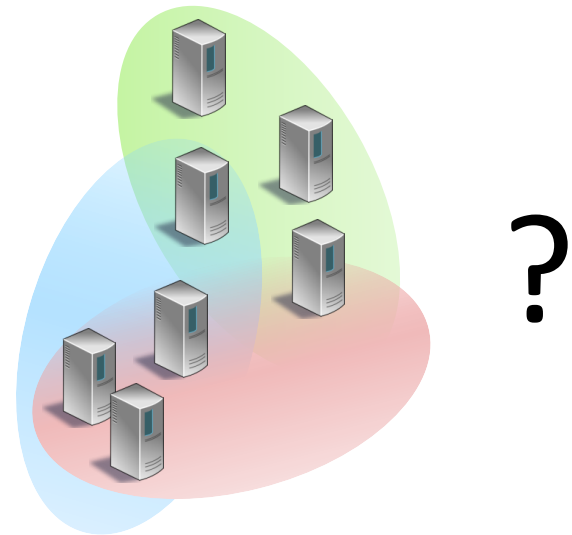

# Quorum: Primary Copy vs. Majority

	Singleton	Majority
How many servers need to be contacted? (Work)	1	$> n/2$
What's the load of the busiest server? (Load)	100%	$\approx 50\%$
How many server failures can be tolerated? (Resilience)	0	$< n/2$

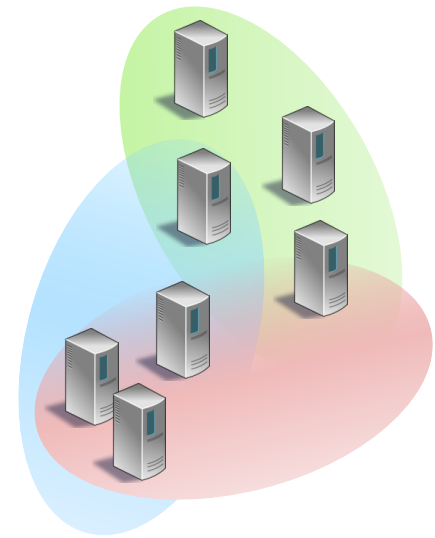
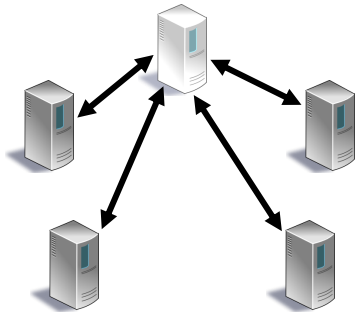

# Definition: Quorum System

## Definition

### Quorum System

Let  $P = \{P_1, \dots, P_n\}$  be a set of servers.

A quorum system  $\mathcal{Q} \subset 2^P$  is a set of subsets of  $P$  such that every two subsets intersect. Each  $Q \in \mathcal{Q}$  is called a quorum.

## Definition

### Minimal Quorum System

A quorum system  $\mathcal{Q}$  is called minimal if  $\forall Q, Q' \in \mathcal{Q}: Q \not\subseteq Q'$

# Definition: Load

## Definition

### Access Strategy

An access strategy  $W$  is a random variable on a quorum system  $\mathcal{Q}$ , i.e.  $\sum_{Q \in \mathcal{Q}} P_W(Q) = 1$

## Definition

### Load

The load induced by access strategy  $W$  on a server  $P_i$  is:

$$l_W(i) = \sum_{Q \in \mathcal{Q}; P_i \in Q} P_W(Q)$$

The load induced by  $W$  on a quorum system  $\mathcal{Q}$  is the maximal load induced by  $W$  on any server in  $\mathcal{Q}$ .

$$L_W(\mathcal{Q}) = \max_{\forall P_i} l_W(i)$$

The system load of  $\mathcal{Q}$  is

$$L(\mathcal{Q}) = \min_{\forall W} L_W(\mathcal{Q})$$

# Quorum: Grid

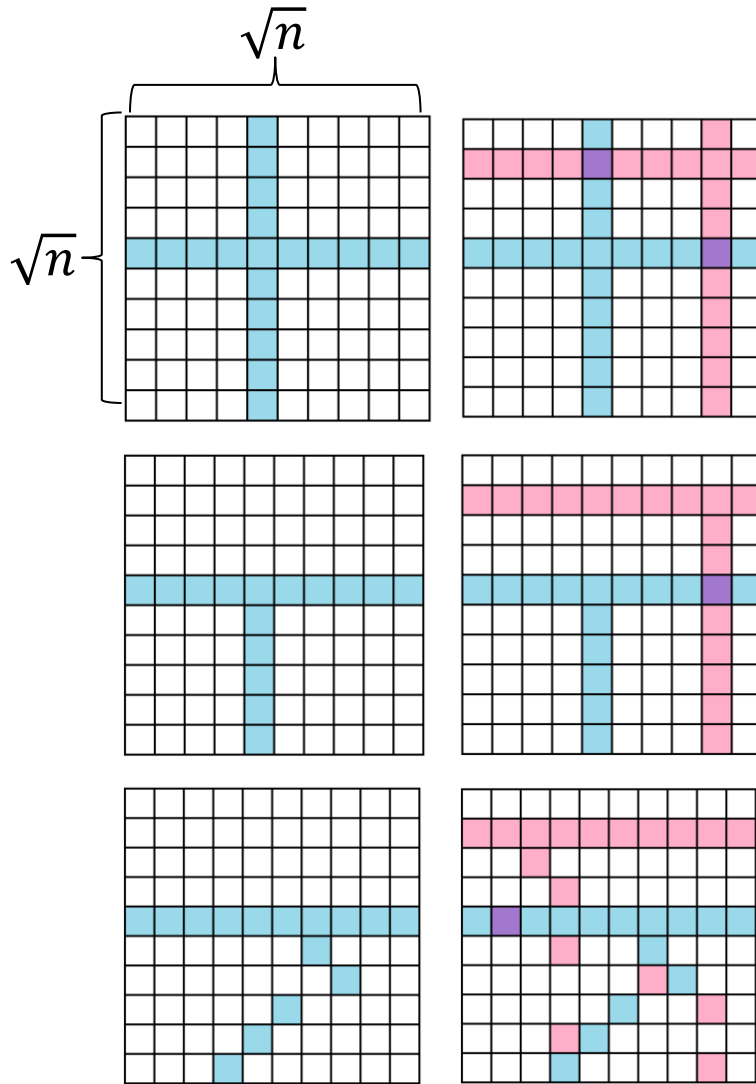

- Work:  $2\sqrt{n} - 1$
- Load:  $\frac{2\sqrt{n} - 1}{n}$

# Definitions: Fault Tolerance

## Definition

### Resilience

The resilience  $R(Q)$  of a quorum system is the largest  $f$  such that for all sets  $F \subset P$ ,  $|F| = f$ , there is at least one quorum  $Q \in \mathcal{Q}$  with  $F \cap Q = \emptyset$

## Definition

### Failure Probability

Assume that each server fails independently with probability  $p$ . The failure probability of a quorum system  $\mathcal{Q}$  is the probability that no quorum  $Q \in \mathcal{Q}$  is available.



# Quorum: B-Grid

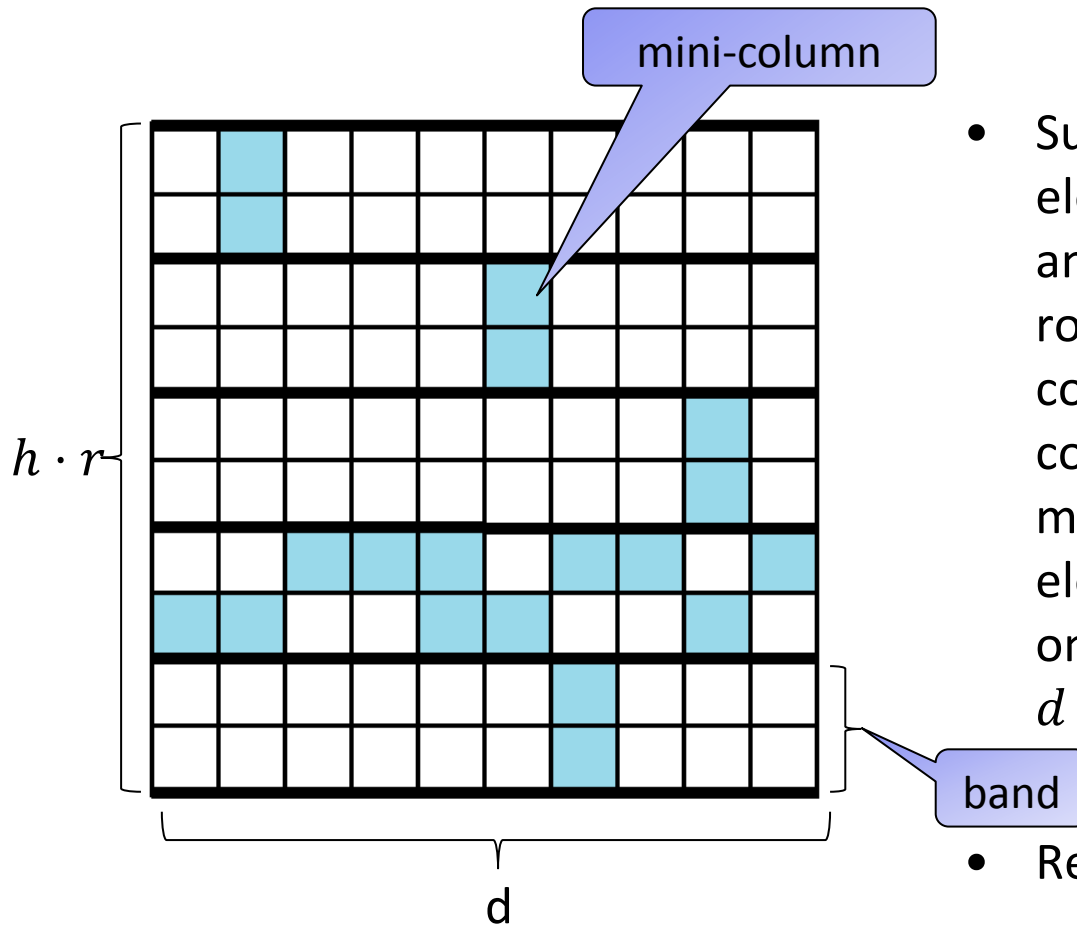

- Suppose  $n = dhr$  and arrange the elements in a grid with  $d$  columns and  $h \cdot r$  rows. Call every group of  $r$  rows a band and call  $r$  elements in a column restricted to a band a mini-column. A quorum consists of one mini-column in every band and one element from each mini-column of one band; thus, every quorum has  $d + hr - 1$  elements

- Resilience?

# Quorum Systems: Overview

	Singleton	Majority	Grid	B-Grid**
Work	1	$> n/2$	$\theta(\sqrt{n})$	$\theta(\sqrt{n})$
Load	1	$1/2$	$\theta(1/\sqrt{n})$	$\theta(1/\sqrt{n})$
Resilience	0	$< n/2$	$\sqrt{n} - 1$	$\theta(\sqrt{n})$
Failure Prob.*	$p$	$\rightarrow 0$	$\rightarrow 1$	$\rightarrow 0$

\*Assuming  $p$  constant but significantly less than  $\frac{1}{2}$ .

\*\*B-Grid: We set  $d = \sqrt{n}, r = \log n$

# Chubby

- Chubby is a coarse-grained distributed lock service
  - Coarse-grained: Locks are held for hours or even days
- Chubby allows clients to synchronize activities
  - E.g., synchronize access through a leader in a distributed system
  - The leader is elected using Chubby: The node that gets the lock for this service becomes the leader!
- Design goals are high availability and reliability
  - High performance is not a major issue
- Chubby is used in many tools, services etc. at Google
  - Google File System (GFS)
  - BigTable (distributed database)

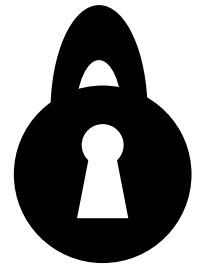

# Chubby: System Structure

- A **Chubby cell** typically consists of 5 servers
  - One server is the master, the others are replicas
  - The clients only communicate with the master
  - Clients find the master by sending master location requests to some replicas listed in the DNS

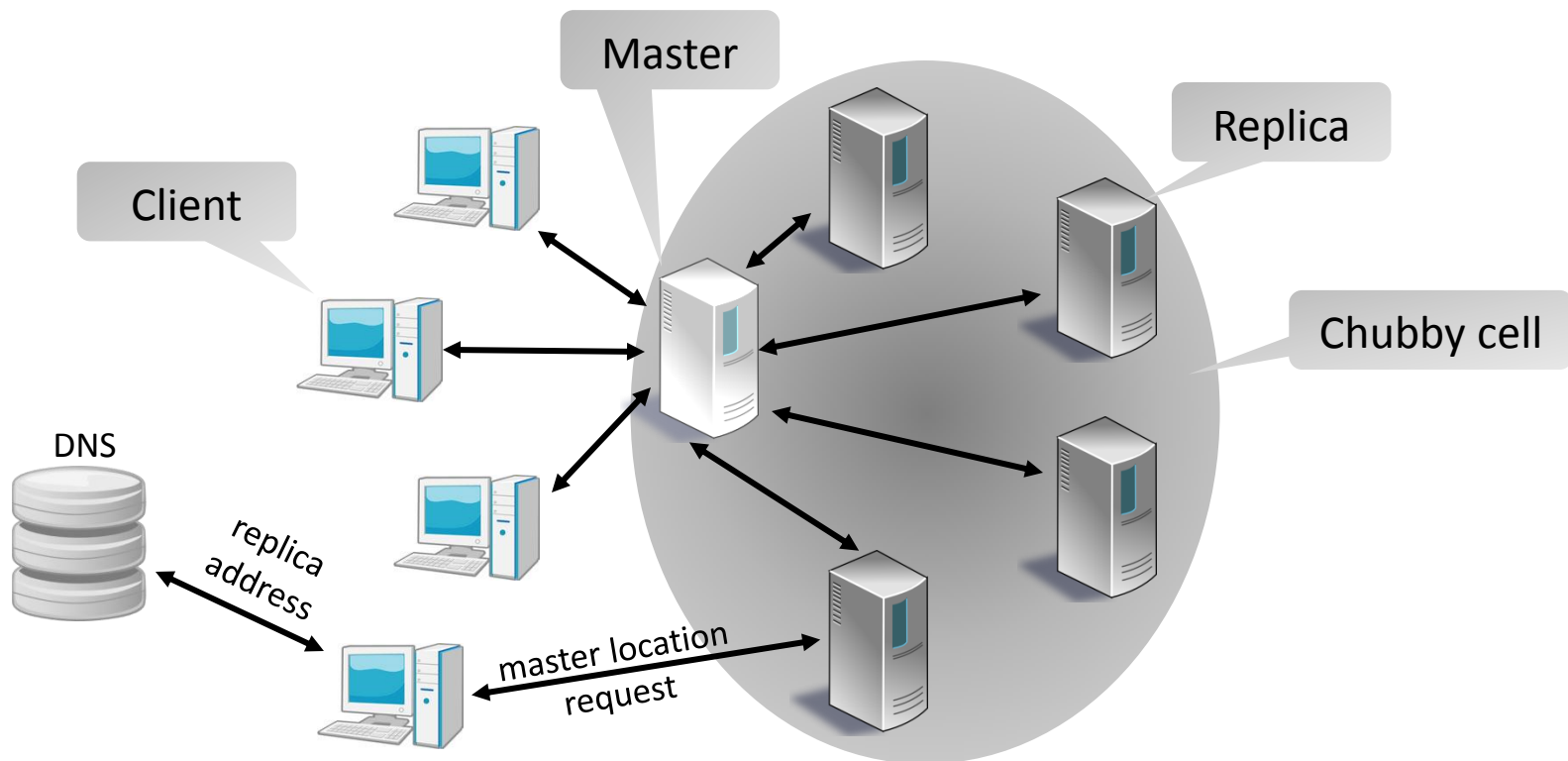

# Chubby: System Structure

- The master handles all read accesses
- The master also handles writes
  - Copies of the updates are sent to the replicas
  - Majority of replicas must acknowledge receipt of update before master writes its own value and updates the official database

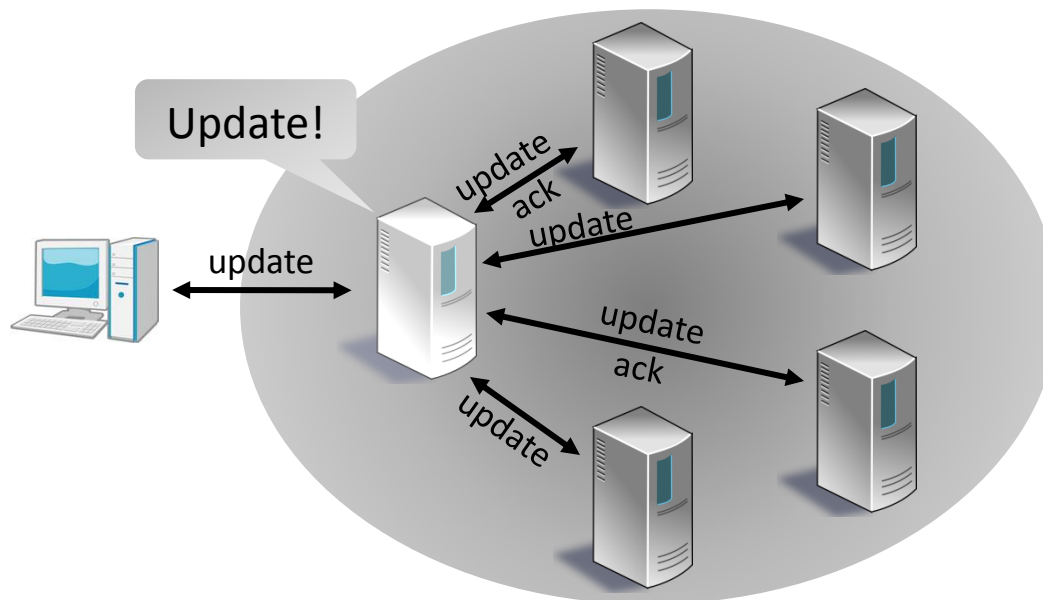

# Chubby: Master Election

- The master remains the master for the duration of the **master lease**
  - Before the lease expires, the master can renew it (and remain the master)
  - It is guaranteed that no new master is elected before the lease expires
  - However, a new master is elected as soon as the lease expires
  - This ensures that the system does not freeze (for a long time) if the master crashed
- How do the servers in the Chubby cell agree on a master?
- They run (a variant of) the Paxos algorithm!

# Chubby: Locks

- Locks are **advisory** (not **mandatory**)
  - As usual, locks are **mutually exclusive**
  - However, data can be *read* without the lock!
  - Advisory locks are more **efficient** than **mandatory** locks (where any access requires the lock): Most accesses are reads! If a **mandatory** lock is used and the lock holder crashes, then all reads are stalled until the situation is resolved
  - Write permission to a resource is required to obtain a lock



Advisory:

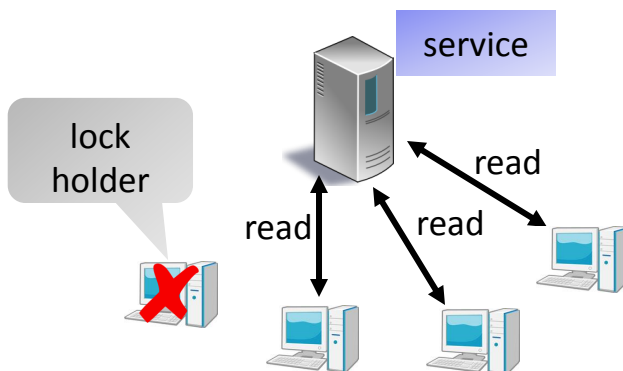

Mandatory:

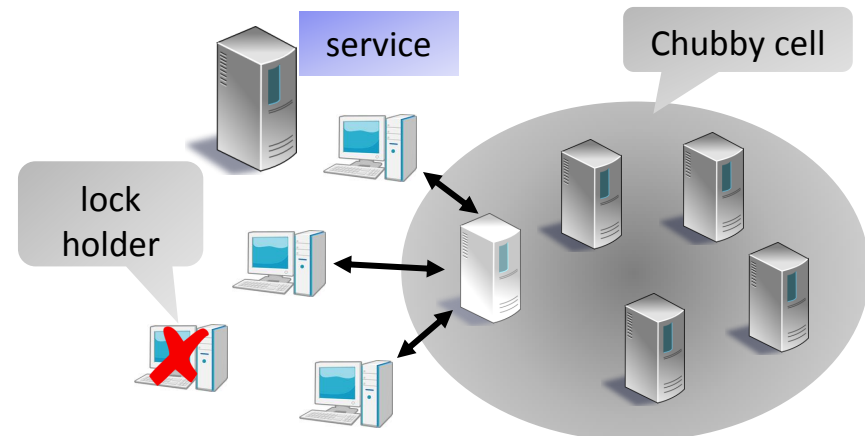

# Chubby: Sessions

- What happens if the lock holder crashes?
- Client initially contacts master to establish a **session**
  - Session: Relationship between Chubby cell and Chubby client
- Each session has an associated **lease**
  - The master can extend the lease, but it may not revoke the lease
  - Longer lease times if the load is high
- Periodic **KeepAlive** (KA) handshake to maintain relationship
  - The master does not respond until the client's previous lease is close to expiring
  - Then it responds with the duration of the new lease
  - The client reacts immediately and issues the next KA
- Ending a session
  - The client terminates the session explicitly
  - or the lease expires

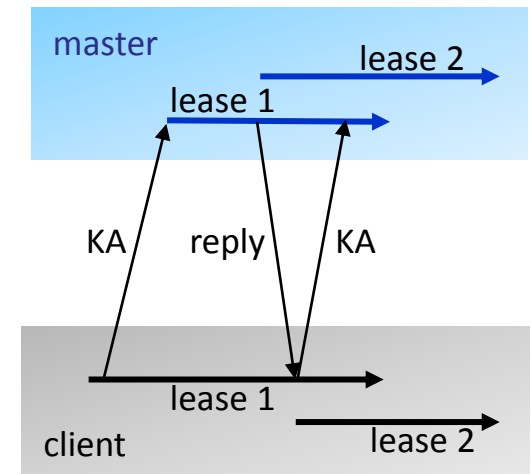



# Chubby: Lease Timeout

- The client maintains a local **lease timeout**
  - The client knows (roughly) when it has to hear from the master again
- If the local lease expires, the session is **in jeopardy**
- As soon as a session is in jeopardy, the **grace period** (45s by default) starts
  - If there is a successful KeepAlive exchange before the end of the grace period, the session is saved!
  - Otherwise, the session expired
- This might happen if the master crashed...

Time when  
lease expires

# Chubby: Master Failure

- The grace period can save sessions

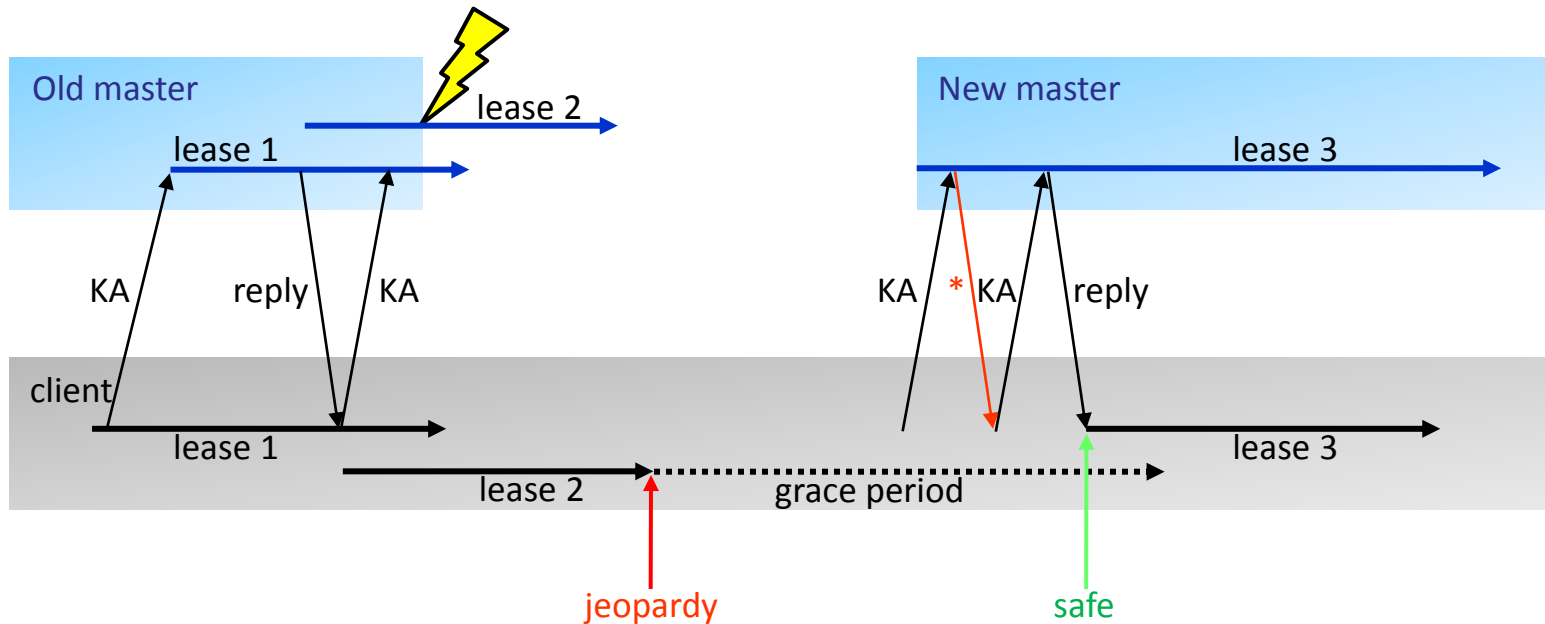

- The client finds the new master using a master location request
- Its first KA to the new master is denied (\*) because the new master has a new **epoch number** (sometimes called **view number**)
- The next KA succeeds with the new number

# Chubby: Master Failure

- A master failure is detected once the **master lease** expires
- A new master is elected, which tries to resume exactly where the old master left off
  - Read data that the former master wrote to disk (this data is also replicated)
  - Obtain state from clients
- Actions of the new master
  1. It picks a new epoch number
    - It only replies to master location requests
  2. It rebuilds the data structures of the old master
    - Now it also accepts KeepAlives
  3. It informs all clients about failure → Clients flush cache
    - All operations can proceed



We omit caching in this lecture!

# Chubby: Locks Reloaded

- What if a lock holder crashes and its (write) request is still in transit?
  - This write may undo an operation of the next lock holder!

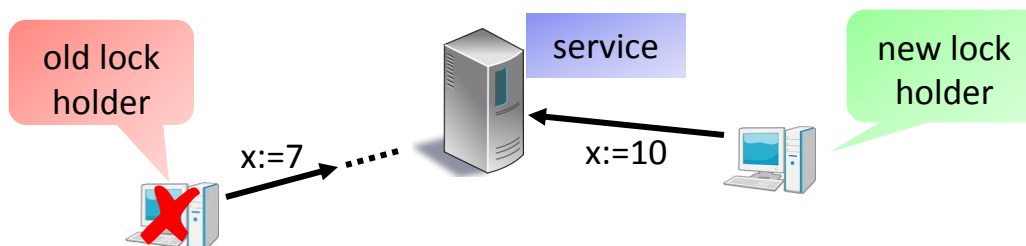

- Heuristic I: Sequencer
  - Add a **sequencer** (which describes the state of the lock) to the access requests
  - The **sequencer** is a bit string that contains the name of lock, the mode (exclusive/shared), and the **lock generation number**
  - The client passes the **sequencer** to server. The server is expected to check if the sequencer is still valid and has the appropriate mode
- Heuristic II: Delay access
  - If a lock holder crashed, Chubby blocks the lock for a period called the **lock delay**

# Chubby: Replica Replacement

- What happens when a replica crashes?
  - If it does not recover for a few hours, a replacement system selects a fresh machine from a pool of machines
  - Subsequently, the DNS tables are updated by replacing the IP address of the failed replica with the new one
  - The master polls the DNS periodically and eventually notices the change

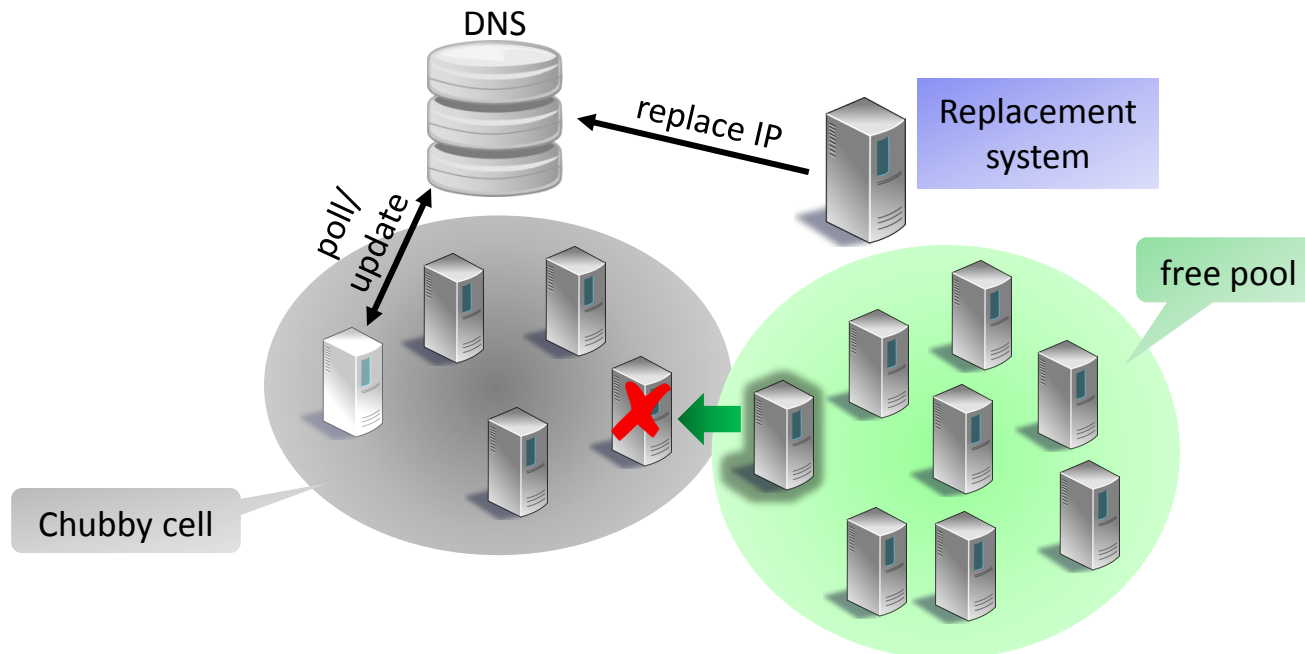

# Chubby: Performance

- According to Chubby...
  - Chubby performs quite well
- 90K+ clients can communicate with a single Chubby master (2 CPUs)
- System increases lease times from 12s up to 60s under heavy load
- Clients cache virtually everything
- Only little state has to be stored
  - All data is held in RAM (but also persistently stored on disk)

# Practical Byzantine Fault-Tolerance

- So far, we have only looked at systems that deal with simple (crash) failures
- We know that there are other kind of failures:

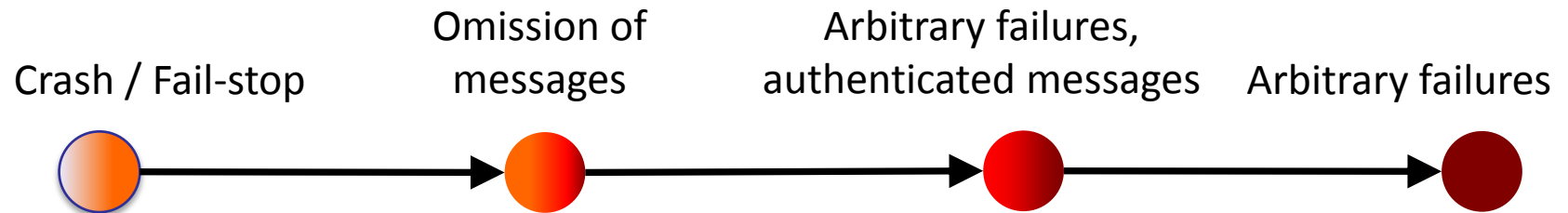

# Practical Byzantine Fault-Tolerance

- Is it reasonable to consider **Byzantine behavior** in practical systems?
- There are several reasons why clients/servers may behave “arbitrarily”
  - Malfunctioning hardware
  - Buggy software
  - Malicious attacks
- Can we have a practical and efficient system that tolerates Byzantine behavior...?
  - We again need to solve consensus...



# PBFT

- We are now going to study the Practical Byzantine Fault-Tolerant (PBFT) system
- The system consists of **clients** that read/write data stored at  **$n$  servers**
- Goal
  - The system can be used to implement any **deterministic** replicated service with a *state* and some *operations*
  - Provide **reliability** and **availability**
- Model
  - Communication is **asynchronous**, but message delays are bounded
  - Messages may be lost, duplicated or may arrive out of order
  - Messages can be **authenticated** using digital signatures (in order to prevent spoofing, replay, impersonation)
  - At most  $f < n/3$  of the servers are **Byzantine**

# PBFT: Order of Operations

- State replication (repetition): If all servers start in the **same state**, all operations are **deterministic**, and all operations are executed in the **same order**, then all servers remain in the same state!
- Variable message delays may be a problem:

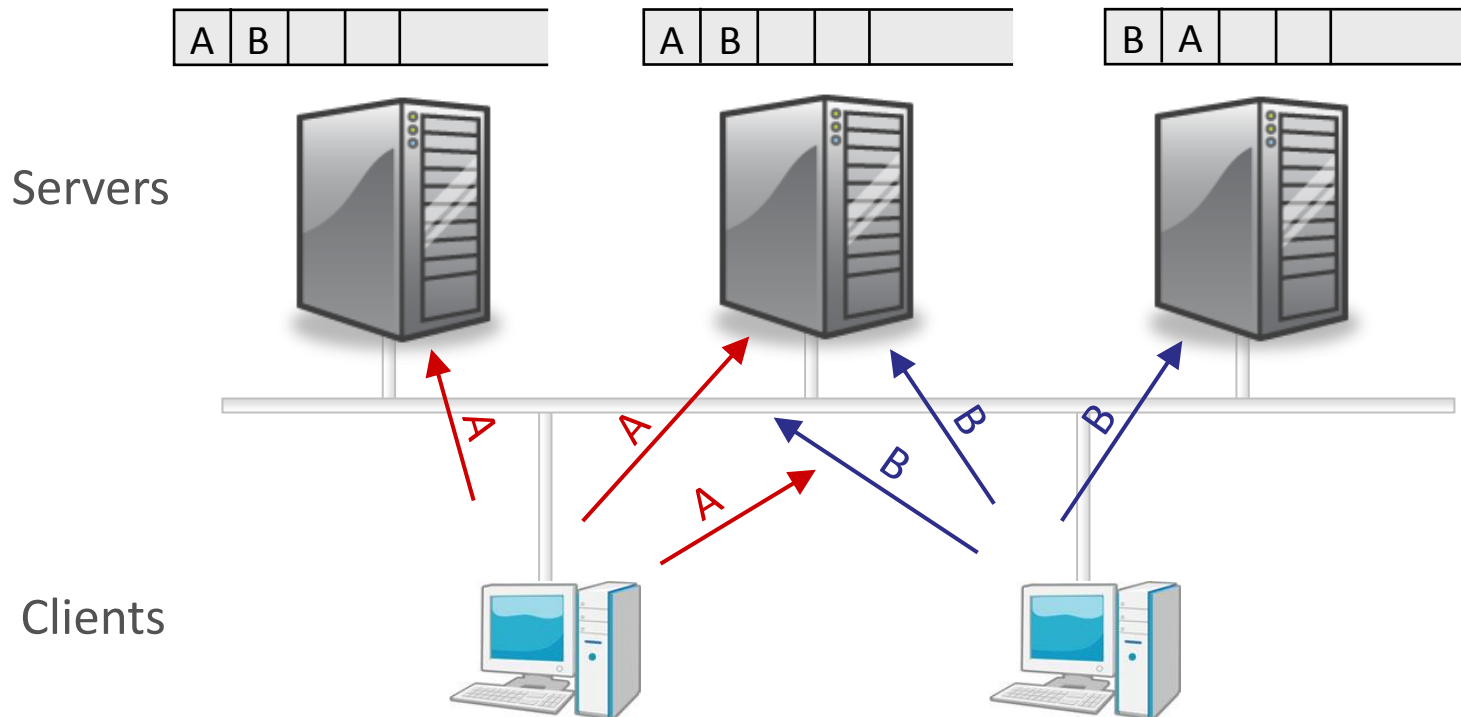

# PBFT: Order of Operations

- If messages are lost, some servers may not receive all updates...

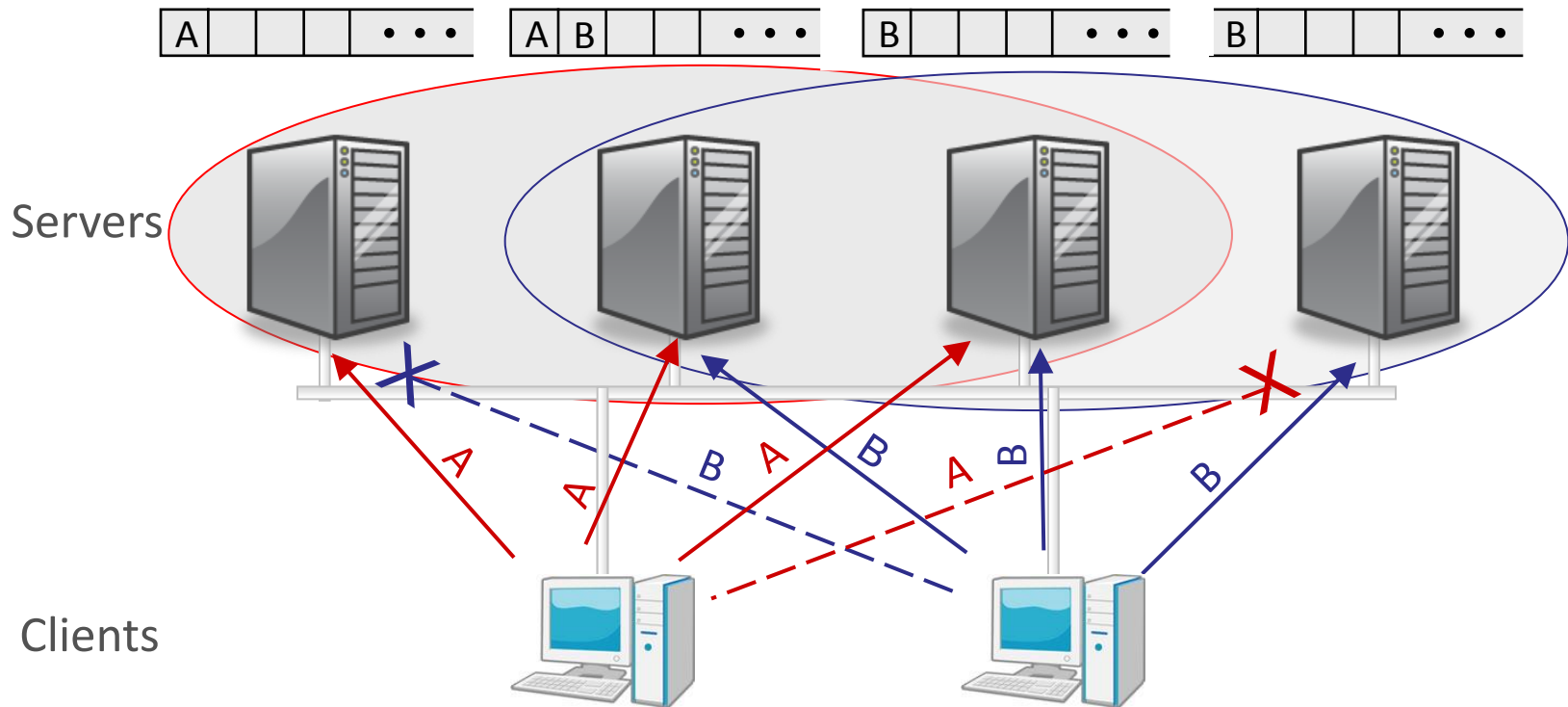

# PBFT: Basic Idea

- Such problems can be solved by using a coordinator
- One server is the **primary**
  - The clients send **signed** commands to the primary
  - The primary assigns sequence numbers to the commands
  - These sequence numbers impose an order on the commands
- The other servers are **backups**
  - The primary forwards commands to the other servers
  - Information about commands is replicated at a **quorum** of backups

PBFT is not as decentralized as Paxos!

Quorum...?

- Note that we assume in the following that there are *exactly*  $n = 3f+1$  servers!

# Byzantine Quorums

Now, a quorum is any subset of the servers of size at least  $2f+1$

- The intersection between any two quorums contains at least one correct (not Byzantine) server

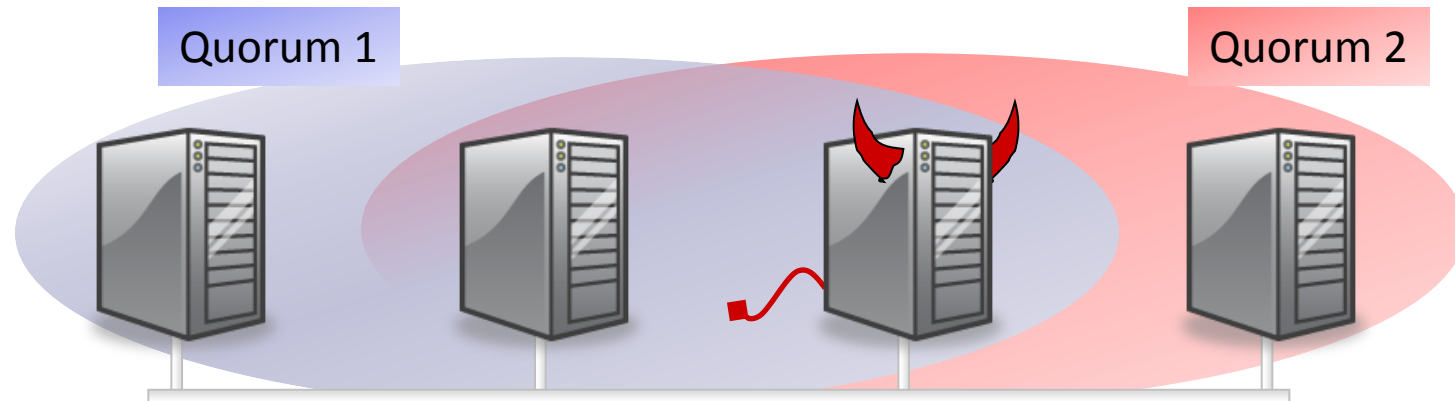

# PBFT: Main Algorithm

- PBFT takes 5 rounds of communication
- In the first round, the client sends the command `op` to the primary
- The following three rounds are
  - Pre-prepare
  - Prepare
  - Propose
- In the fifth round, the client receives replies from the servers
  - If  $f+1$  (authenticated) replies are the same, the result is accepted
  - Since there are only  $f$  Byzantine servers, at least one correct server supports the result
- The algorithm is somewhat similar to Paxos...

# PBFT: Paxos

- In Paxos, there is only a **prepare** and a **propose** phase
- The primary is the node issuing the proposal
- In the response phase, the clients learn the final result

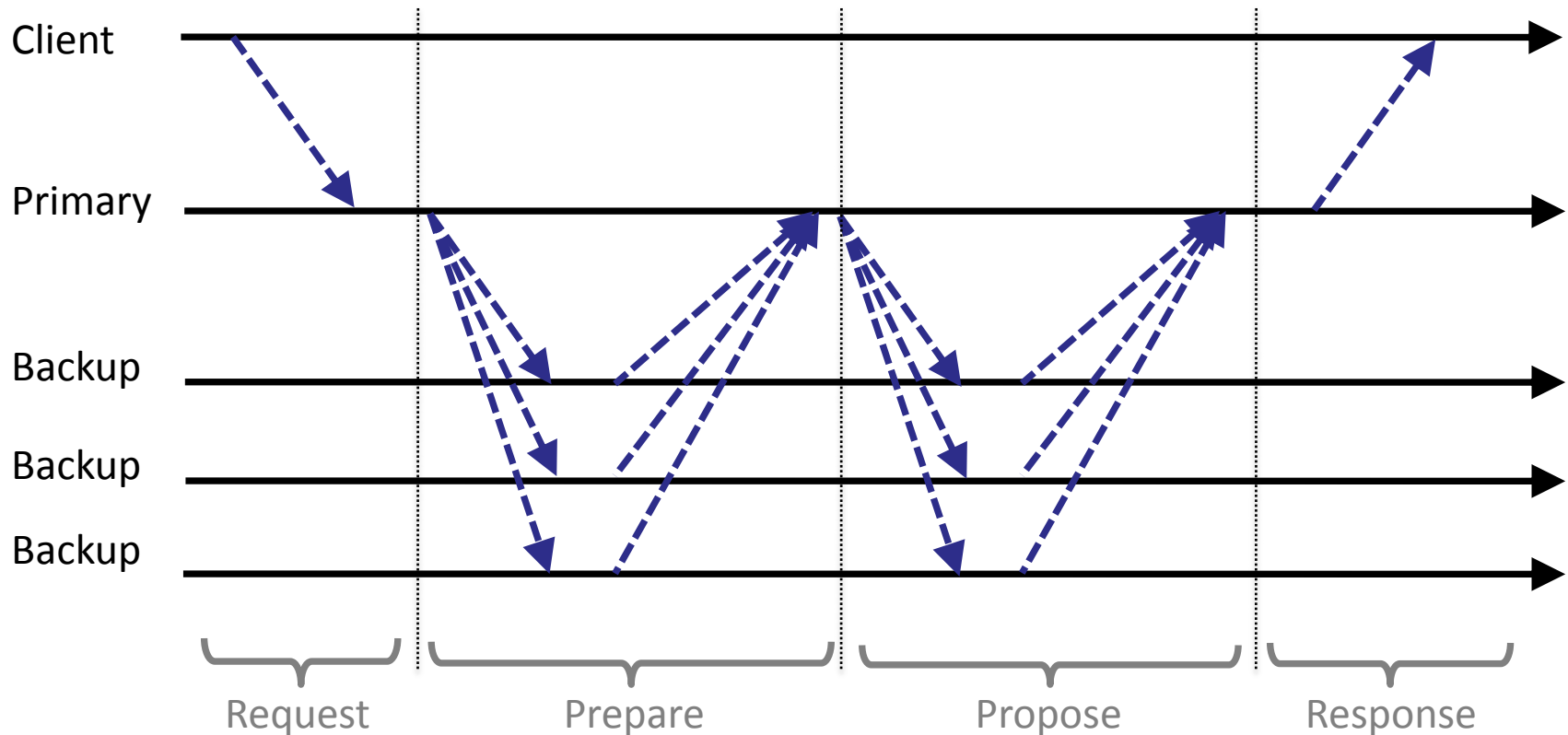

# PBFT: Algorithm

- PBFT takes 5 rounds of communication
- The main parts are the three rounds **pre-prepare**, **prepare**, and **commit**

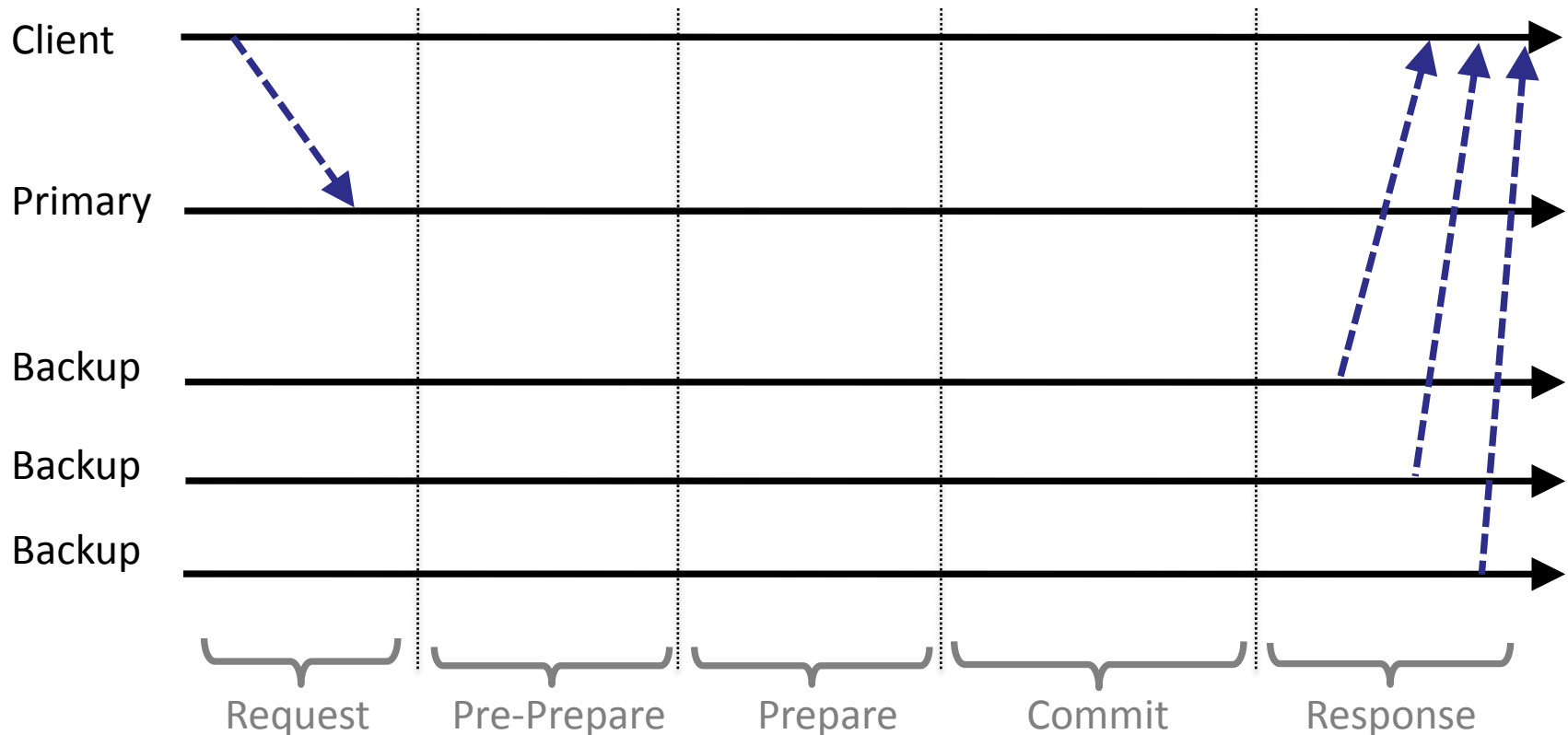



# PBFT: Request Phase

- In the first round, the client sends the command **op** to the primary
- It also sends a timestamp **ts**, a client identifier **c-id** and a signature **c-sig**

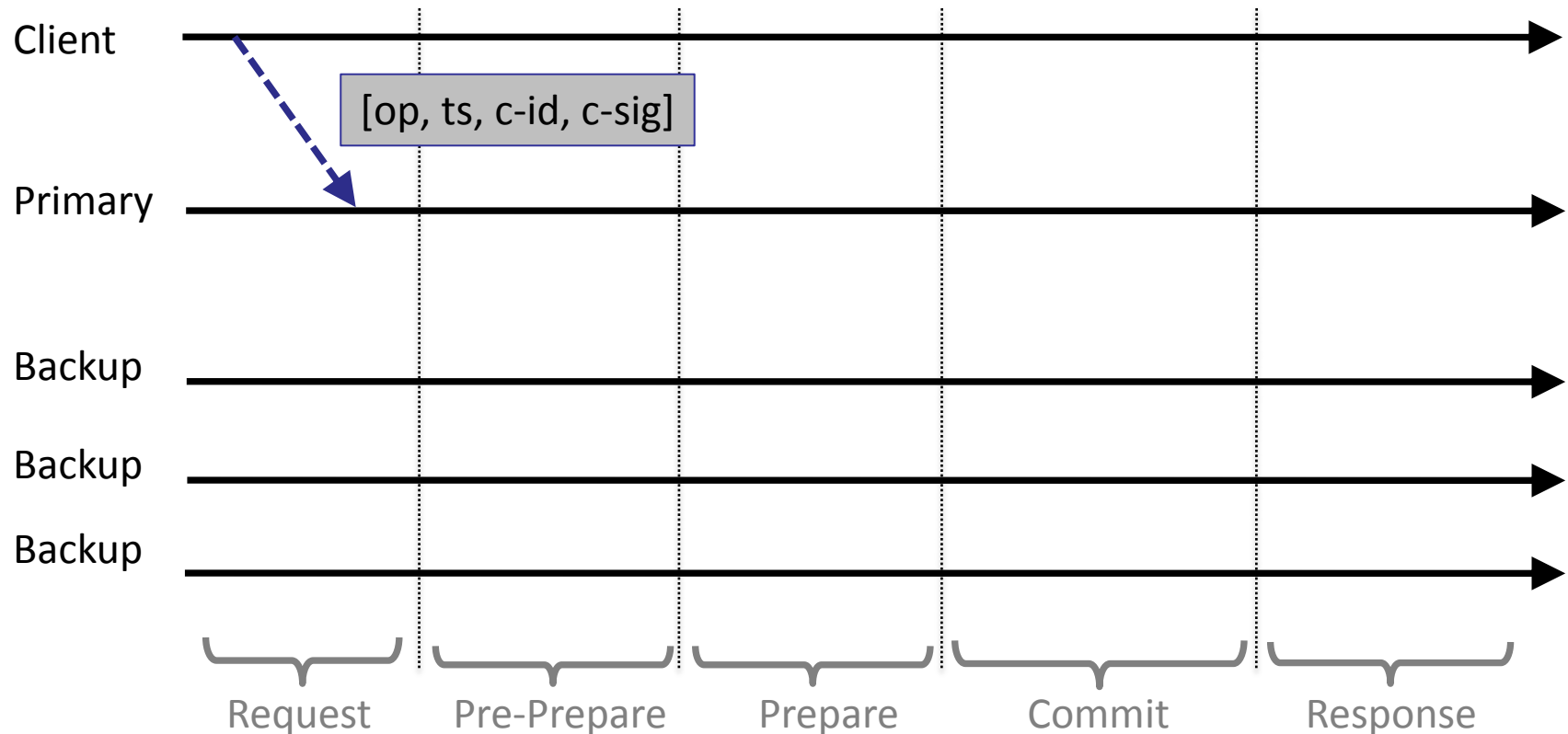

# PBFT: Request Phase

- Why adding a timestamp?
  - The timestamp ensures that a command is recorded/executed exactly once
- Why adding a signature?
  - It is not possible for another client (or a Byzantine server) to issue commands that are accepted as commands from client  $c$
  - The system also performs access control: If a client  $c$  is allowed to write a variable  $x$  but  $c'$  is not,  $c'$  cannot issue a write command by pretending to be client  $c$ !

# PBFT: Pre-Prepare Phase

- In the second round, the primary multicasts  $m = [op, ts, cid, c-sig]$  to the backups, including the view number  $vn$ , the assigned sequence number  $sn$ , the message digest  $D(m)$  of  $m$ , and its own signature  $p-sig$

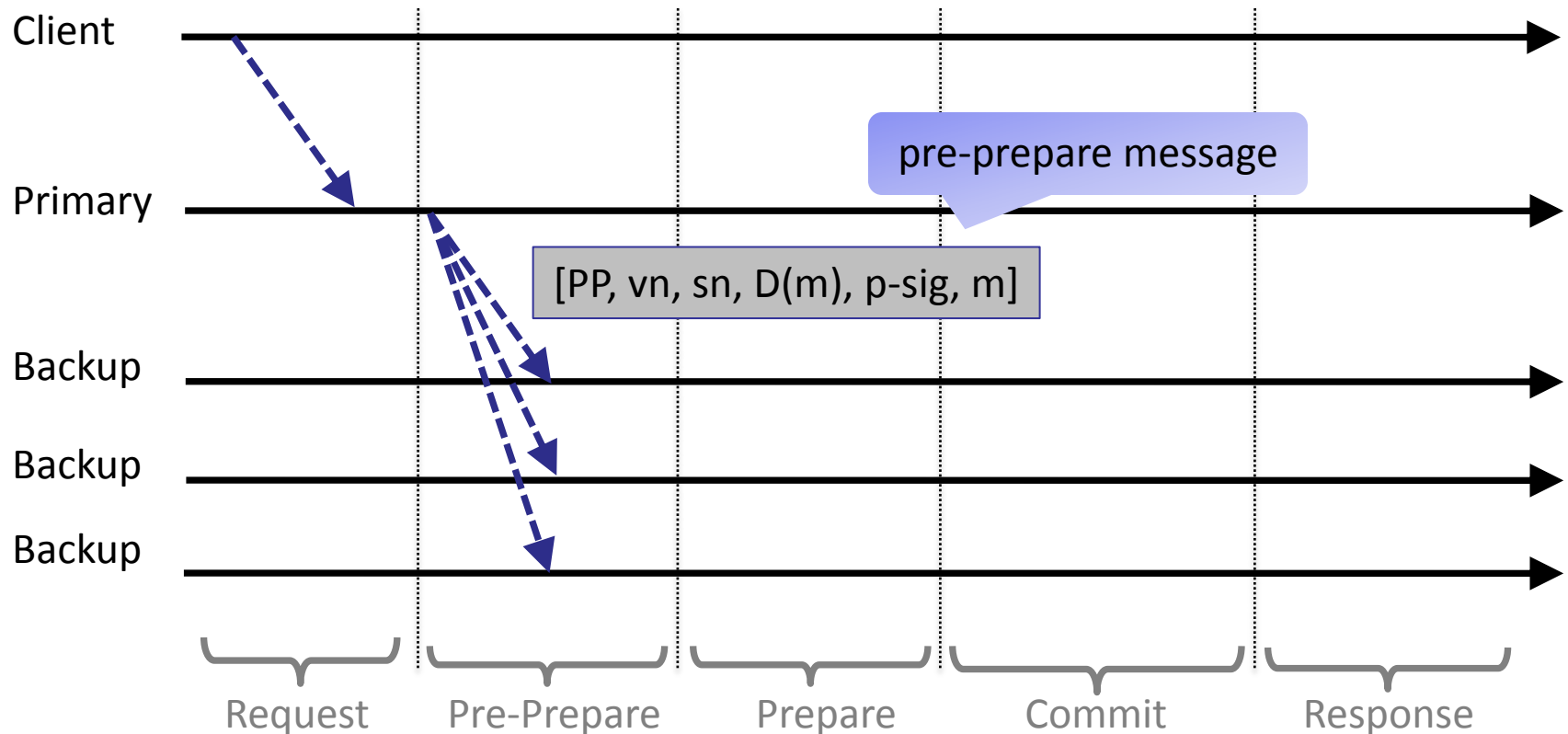

# PBFT: Pre-Prepare Phase

- The sequence numbers are used to order the commands and the signature is used to verify the authenticity as before
- Why adding the message digest of the client's message?
  - The primary signs only  $[PP, vn, sn, D(m)]$ . This is more efficient!
- What is a **view**?
  - A view is a configuration of the system. Here we assume that the system comprises the same set of servers, one of which is the primary
  - I.e., the primary determines the view: Two views are different if a different server is the primary
  - A view number identifies a **view**
  - The primary in view  $vn$  is the server whose identifier is  $vn \bmod n$
  - Ideally, all servers are (always) in the same view
  - A **view change** occurs if a different primary is **elected**

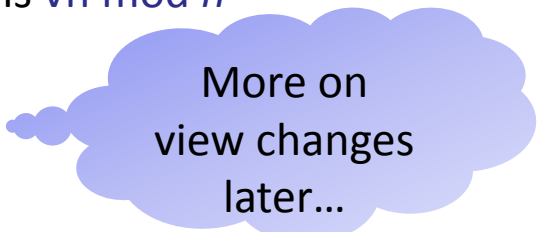

More on  
view changes  
later...

# PBFT: Pre-Prepare Phase

- A backup **accepts** a **pre-prepare** message if
  - the **signatures** are correct
  - $D(m)$  is the digest of  $m = [op, ts, cid, c-sig]$
  - it is in view **vn**
  - It has not accepted a pre-prepare message for view number **vn** and sequence number **sn** containing a different digest
  - the sequence number is between a **low water mark h** and a **high water mark H**
  - The last condition prevents a faulty primary from exhausting the space of sequence numbers
- Each accepted pre-prepare message is stored in the local log

# PBFT: Prepare Phase

- If a backup  $b$  accepts the pre-prepare message, it enters the prepare phase and multicasts  $[P, vn, sn, D(m), b-id, b-sig]$  to all other replicas and stores this prepare message in its log

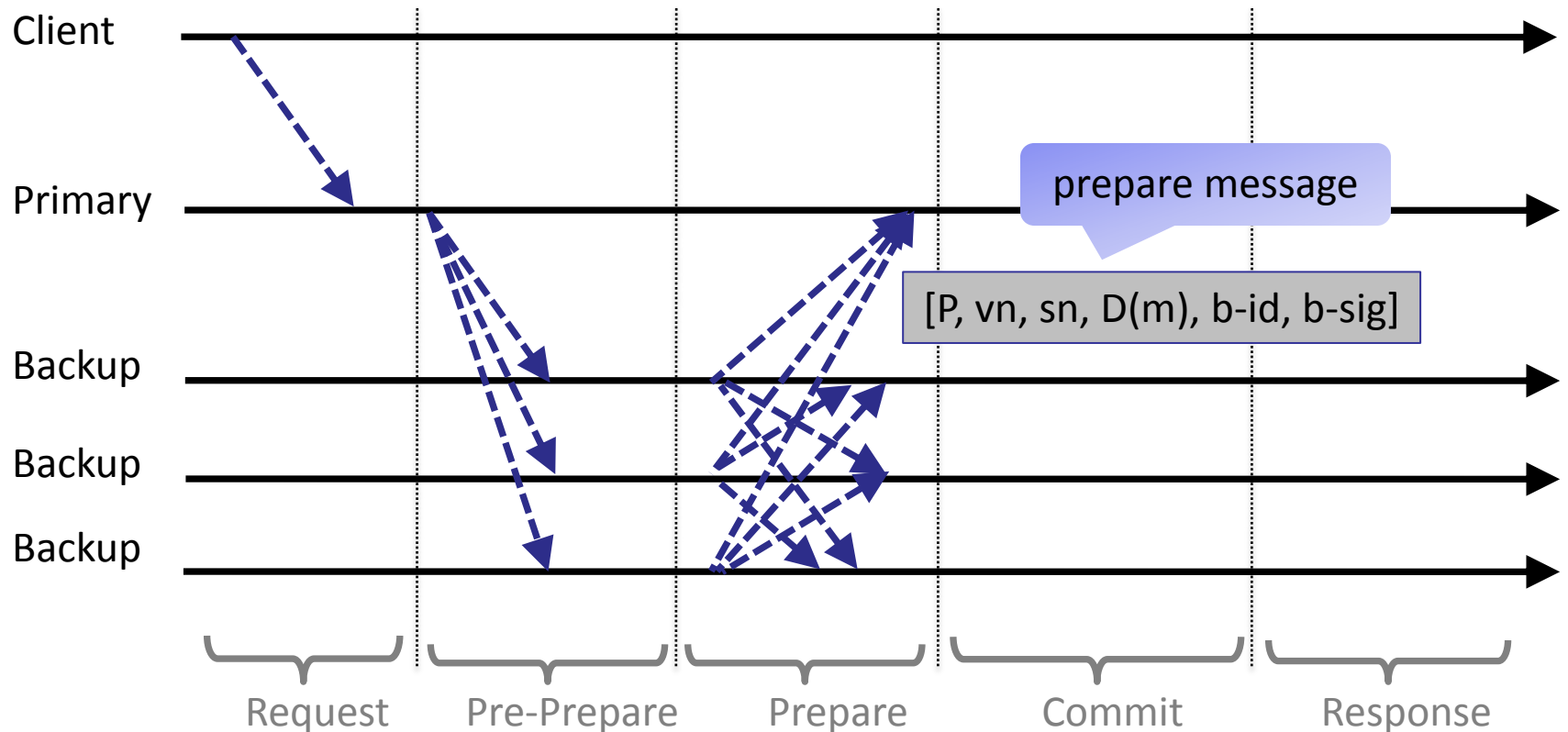

# PBFT: Prepare Phase

- A replica (including the primary) **accepts** a **prepare** message if
  - the **signatures** are correct
  - it is in view **vn**
  - the sequence number is between a **low water mark h** and a **high water mark H**
- Each accepted **prepare** message is also stored in the local log

# PBFT: Commit Phase

- If a backup  $b$  has message  $m$ , an **accepted pre-prepare** message, and  $2f$  **accepted prepare** messages from different replicas in its log, it multicasts  $[C, vn, sn, D(m), b-id, b-sig]$  to all other replicas and stores this commit message

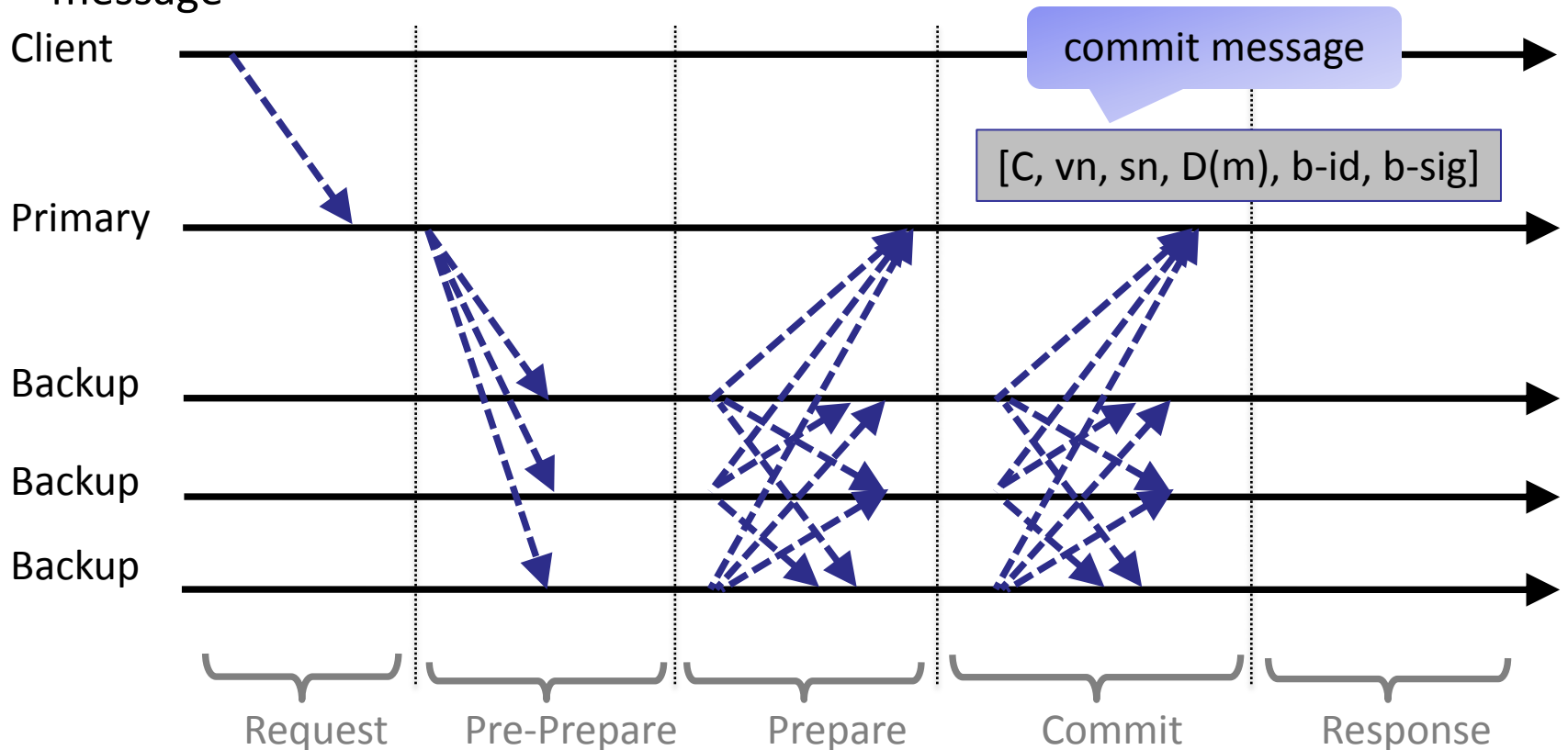



# PBFT: Commit Phase

- A replica (including the primary) **accepts** a **commit** message if
  - the **signatures** are correct
  - it is in view **vn**
  - the sequence number is between a **low water mark h** and a **high water mark H**
- Each accepted **commit** message is also stored in the local log

# PBFT: Response Phase

- If a backup  $b$  has **accepted  $2f+1$  commit** messages, it performs op (“commits”) and sends a reply to the client

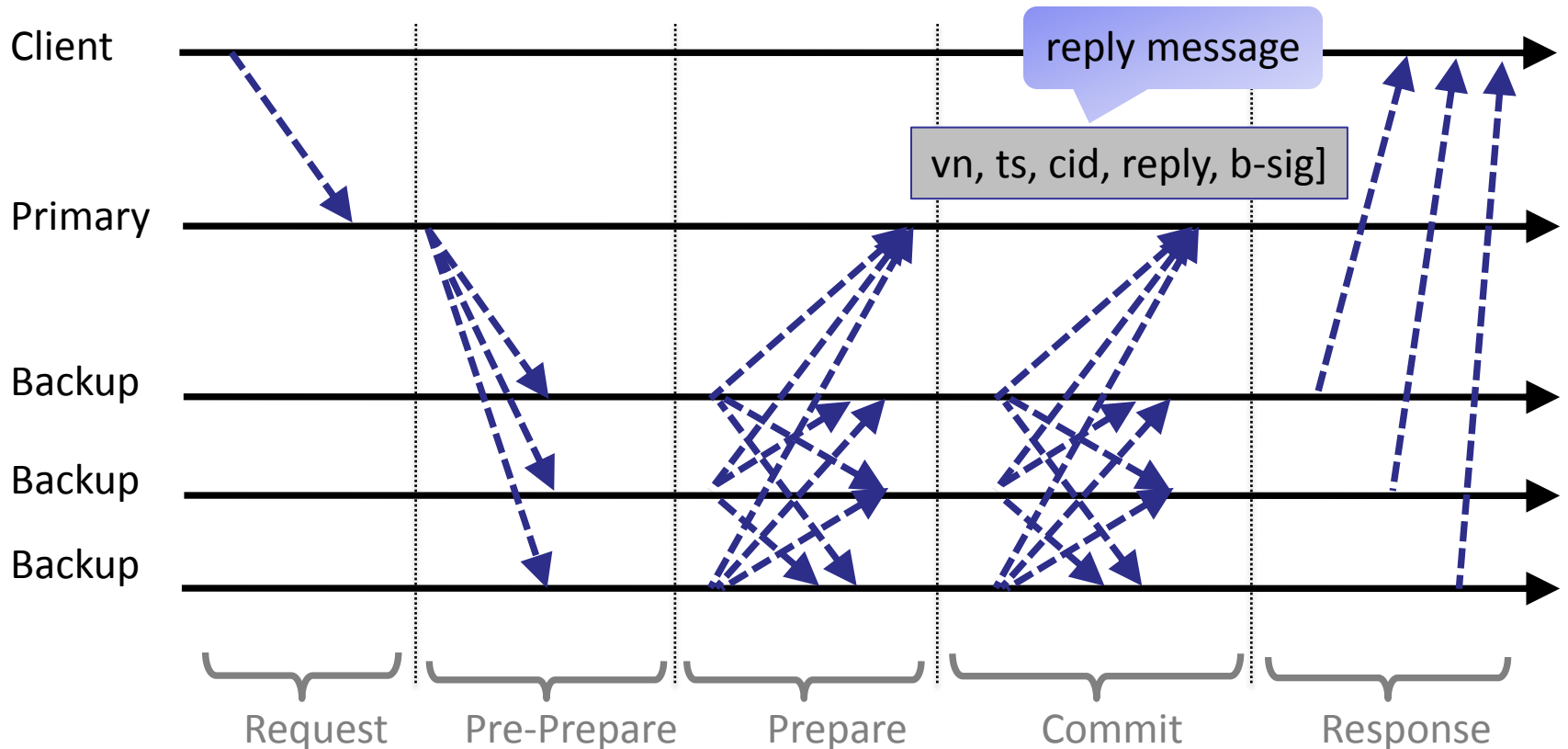

# PBFT: Garbage Collection

- The servers store all messages in their log
- In order to discard messages in the log, the servers create **checkpoints** (snapshots of the state) every once in a while
- A **checkpoint** contains the  $2f+1$  signed commit messages for the committed commands in the log
- The **checkpoint** is multicast to all other servers
- If a server receives  $2f+1$  matching **checkpoint messages**, the **checkpoint** becomes stable and any command that preceded the commands in the checkpoint are discarded
- Note that the checkpoints are also used to set the **low water mark h**
  - to the sequence number of the last stable checkpointand the **high water mark H**
  - to a “sufficiently large” value

# PBFT: Correct Primary

- If the primary is correct, the algorithm works
  - All  $2f+1$  correct nodes receive pre-prepare messages and send prepare messages
  - All  $2f+1$  correct nodes receive  $2f+1$  prepare messages and send commit messages
  - All  $2f+1$  correct nodes receive  $2f+1$  commit messages, commit, and send a reply to the client
  - The client accepts the result

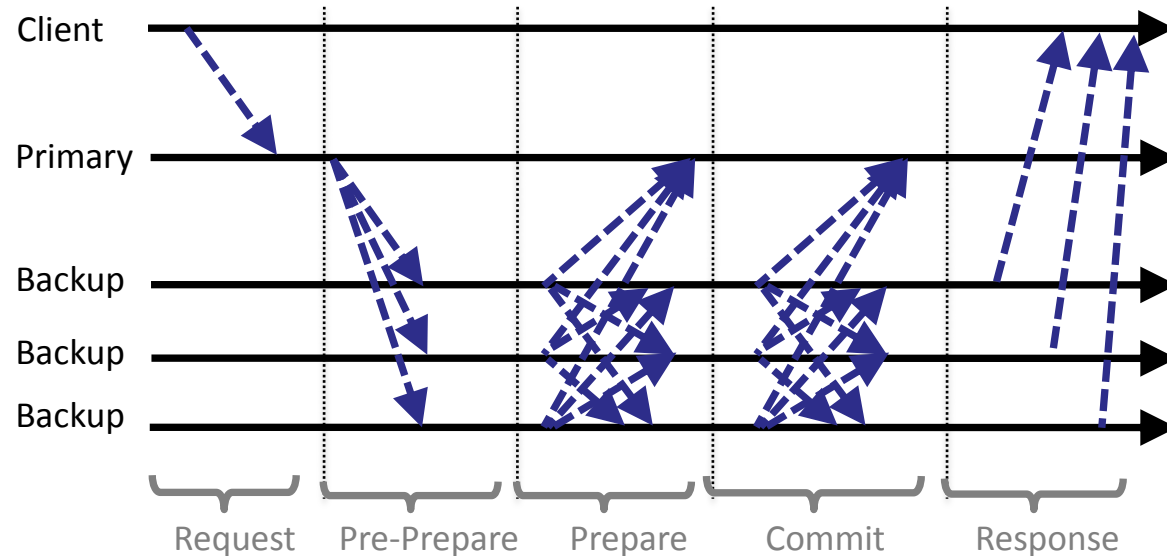

# PBFT: No Replies

- What happens if the client does not receive replies?
  - Because the command message has been lost
  - Because the primary is Byzantine and did not forward it
- After a time-out, the client multicasts the command to all servers
  - A server that has already committed the result sends it again
  - A server that is still processing it ignores it
  - A server that has not received the pre-prepare message forwards the command to the primary
  - If the server does not receive the pre-prepare message in return after a certain time, it concludes that the primary is **faulty/Byzantine**

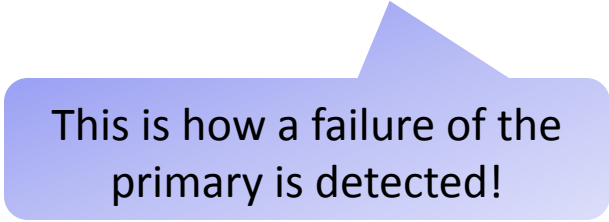

This is how a failure of the primary is detected!

# PBFT: View Change

- If a server suspects that the primary is faulty
  - it stops accepting messages except **checkpoint**, **view change** and **new view** messages
  - it sends a **view change** message containing the identifier  $i = vn+1 \bmod n$  of the next primary and also a **certificate** for each command for which it accepted  $2f+1$  prepare messages
  - A **certificate** simply contains the  $2f+1$  accepted signatures

The next primary!

- When server  $i$  receives  $2f$  **view change** messages from **other** servers, it broadcasts a **new view message** containing the signed view change
- The servers verify the signature and accept the view change!
- The new primary issues **pre-prepare messages** with the new view number for all commands with a correct **certificate**

## PBFT: Ordered Commands

- Commands are totally ordered using the **view numbers** and the **sequence numbers**
- We must ensure that a certain  $(vn, sn)$  pair is always associated with a unique command  $m$ !
- If a correct server committed  $[m, vn, sn]$ , then no other correct server can commit  $[m', vn, sn]$  for any  $m \neq m'$  s.t.  $D(m) \neq D(m')$ 
  - If a correct server committed, it accepted a set of  $2f+1$  authenticated **commit messages**
  - The intersection between two such sets contains at least  $f+1$  authenticated **commit messages**
  - There is at least one correct server in the intersection
  - A correct server does not issue (pre-)prepare messages with the same **vn** and **sn** for different  $m$ !

## PBFT: Correctness

Theorem

If a client accepts a result, no correct server commits a different result

### Proof:

- A client only accepts a result if it receives  $f+1$  authenticated messages with the same result
- At least one correct server must have committed this result
- As we argued on the previous slide, no other correct server can commit a different result



# PBFT: Liveness

Theorem

PBFT terminates eventually

## Proof:

- The primary is correct
  - As we argued before, the algorithm terminates after 5 rounds if no messages are lost
  - Message loss is handled by retransmitting after certain time-outs
  - Assuming that messages arrive eventually, the algorithm also terminates eventually

# PBFT: Liveness

Theorem

PBFT terminates eventually

## Proof continued:

- The primary is Byzantine
  - If the client does not accept an answer in a certain period of time, it sends its command to all servers
  - In this case, the system behaves as if the primary is correct and the algorithm terminates eventually!
- Thus, the Byzantine primary cannot delay the command indefinitely. As we saw before, if the algorithm terminates, the result is correct!
  - i.e., at least one correct server committed this result

# PBFT: Evaluation

- The Andrew benchmark emulates a software development workload
- It has 5 phases:
  1. Create subdirectories recursively
  2. Copy a source tree
  3. Examine the status of all the files in the tree without examining the data
  4. Examine every byte in all the files
  5. Compile and link the files
- It is used to compare 3 systems
  - BFS (PBFT) and 4 replicas and BFS-nr (PBFT without replication)
  - BFS (PBFT) and NFS-std (network file system)
- Measured **normal-case behavior** (i.e. no view changes) in an isolated network

# PBFT: Evaluation

- Most operations in NFS V2 are not **read-only (r/o)**
  - E.g., *read* and *lookup* modify the time-last-accessed attribute
- A second version of PBFT has been tested in which lookups are read-only
- Normal (strict) PBFT is only 26% slower than PBFT without replication  
→ Replication does not cost too much!
- Normal (strict) PBFT is only 3% slower than NFS-std, and PBFT with read-only lookups is even 2% faster!

phase	BFS		BFS-nr
	strict	r/o lookup	
1	0.55 (57%)	0.47 (34%)	0.35
2	9.24 (82%)	7.91 (56%)	5.08
3	7.24 (18%)	6.45 (6%)	6.11
4	8.77 (18%)	7.87 (6%)	7.41
5	38.68 (20%)	38.38 (19%)	32.12
total	64.48 (26%)	61.07 (20%)	51.07

Times are in seconds

phase	BFS		NFS-std
	strict	r/o lookup	
1	0.55 (-69%)	0.47 (-73%)	1.75
2	9.24 (-2%)	7.91 (-16%)	9.46
3	7.24 (35%)	6.45 (20%)	5.36
4	8.77 (32%)	7.87 (19%)	6.60
5	38.68 (-2%)	38.38 (-2%)	39.35
total	64.48 (3%)	61.07 (-2%)	62.52

# PBFT: Discussion

- PBFT guarantees that the commands are totally ordered
- If a client accepts a result, it knows that at least one correct server supports this result
  
- Disadvantages:
- Commit not at all correct servers
  - It is possible that **only one** correct server commits the command
  - We know that  $f$  other correct servers have sent commit, but they may only receive  $f+1$  commits and therefore do not commit themselves...
- Byzantine primary can **slow down** the system
  - Ignore the initial command
  - Send pre-prepare always after the other servers forwarded the command
  - No correct server will force a view change!

# Beating the Lower Bounds...

- We know several crucial impossibility results and lower bounds
  - No **deterministic** algorithm can achieve consensus in **asynchronous** systems even if **only one** node may crash
  - Any deterministic algorithm for synchronous systems that tolerates  $f$  **crash failures** takes at least  **$f+1$  rounds**
- Yet we have just seen a deterministic algorithm/system that
  - achieves consensus in **asynchronous** systems and that tolerates  $f < n/3$  **Byzantine failures**
  - The algorithm only takes **five rounds**...?
- So, why does the algorithm work...?



# Beating the Lower Bounds...

- So, why does the algorithm work...?
- It is not really an asynchronous system
  - There are bounds on the message delays
  - This is almost a synchronous system...
- We used authenticated messages
  - It can be verified if a server really sent a certain message
- The algorithm takes **more than 5 rounds** in the worst case
  - It takes more than  $f$  rounds! . . .

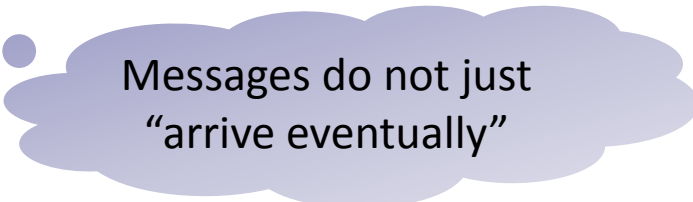

Messages do not just  
“arrive eventually”



Why?

# Zyzyva

- Zyzyva is another BFT protocol
- Idea
  - The protocol should be very efficient if there are no failures
  - The clients **speculatively** execute the command without going through an agreement protocol!
- Problem
  - States of correct servers may **diverge**
  - Clients may receive **diverging/conflicting** responses
- Solution
  - Clients detect inconsistencies in the replies and help the correct servers to converge to a single total ordering of requests



# Zyzyva

- Normal operation: Speculative execution!
- Case 1: All  $3f+1$  report the same result

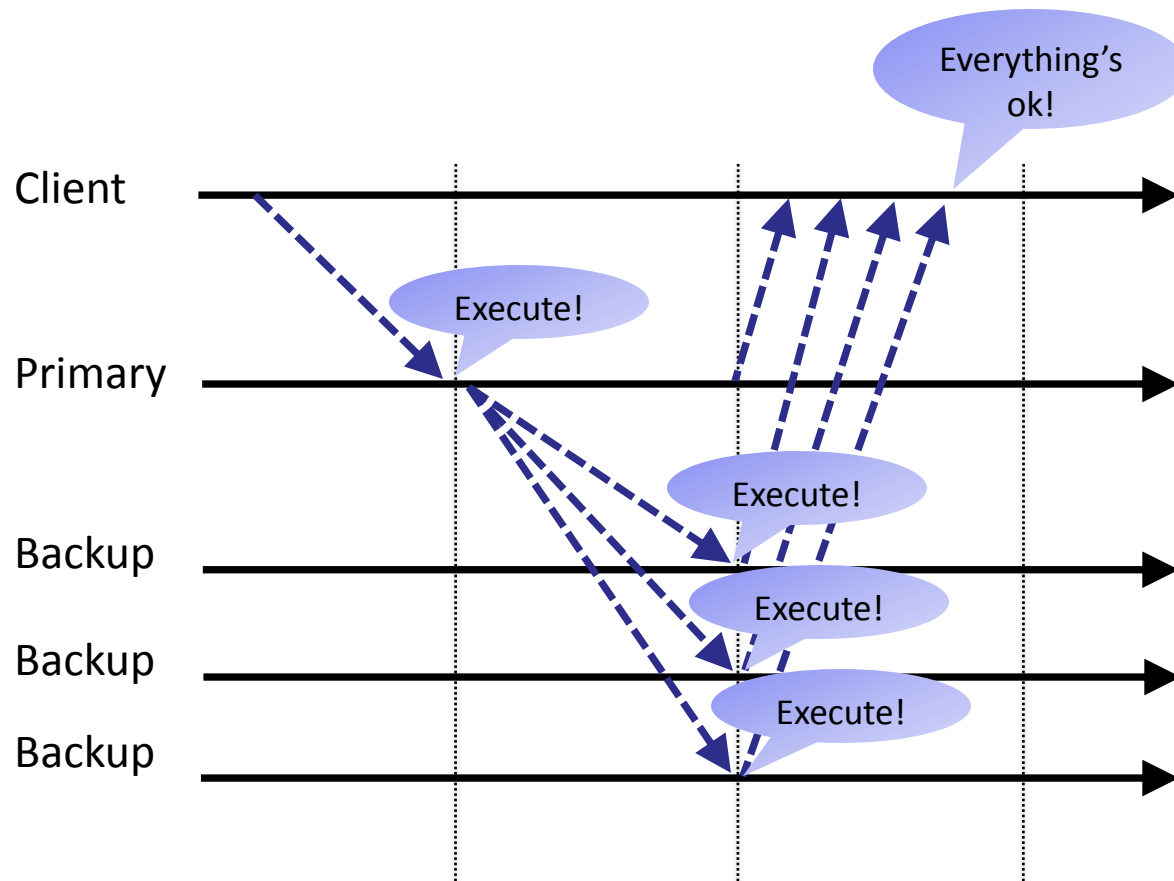

# Zyzyva

- Case 2: Between  $2f+1$  and  $3f$  results are the same
- The client broadcasts a **commit certificate** containing the  $2f+1$  results
- The client commits upon receiving  $2f+1$  replies

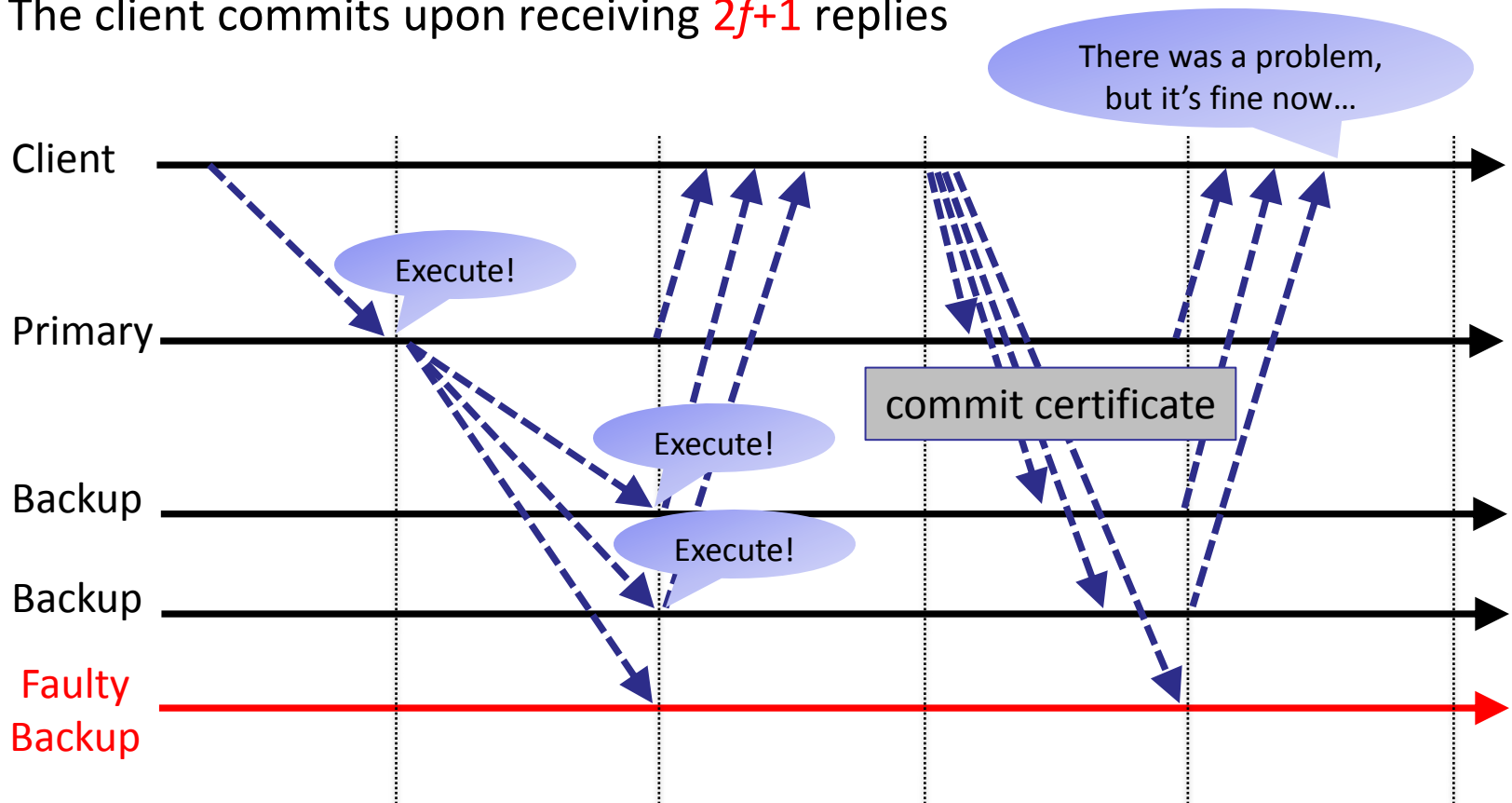

# Zyzyva

- Case 3: Less than  $2f+1$  replies are the same
- The client broadcasts its request to all servers
- This step circumvents a **faulty primary**

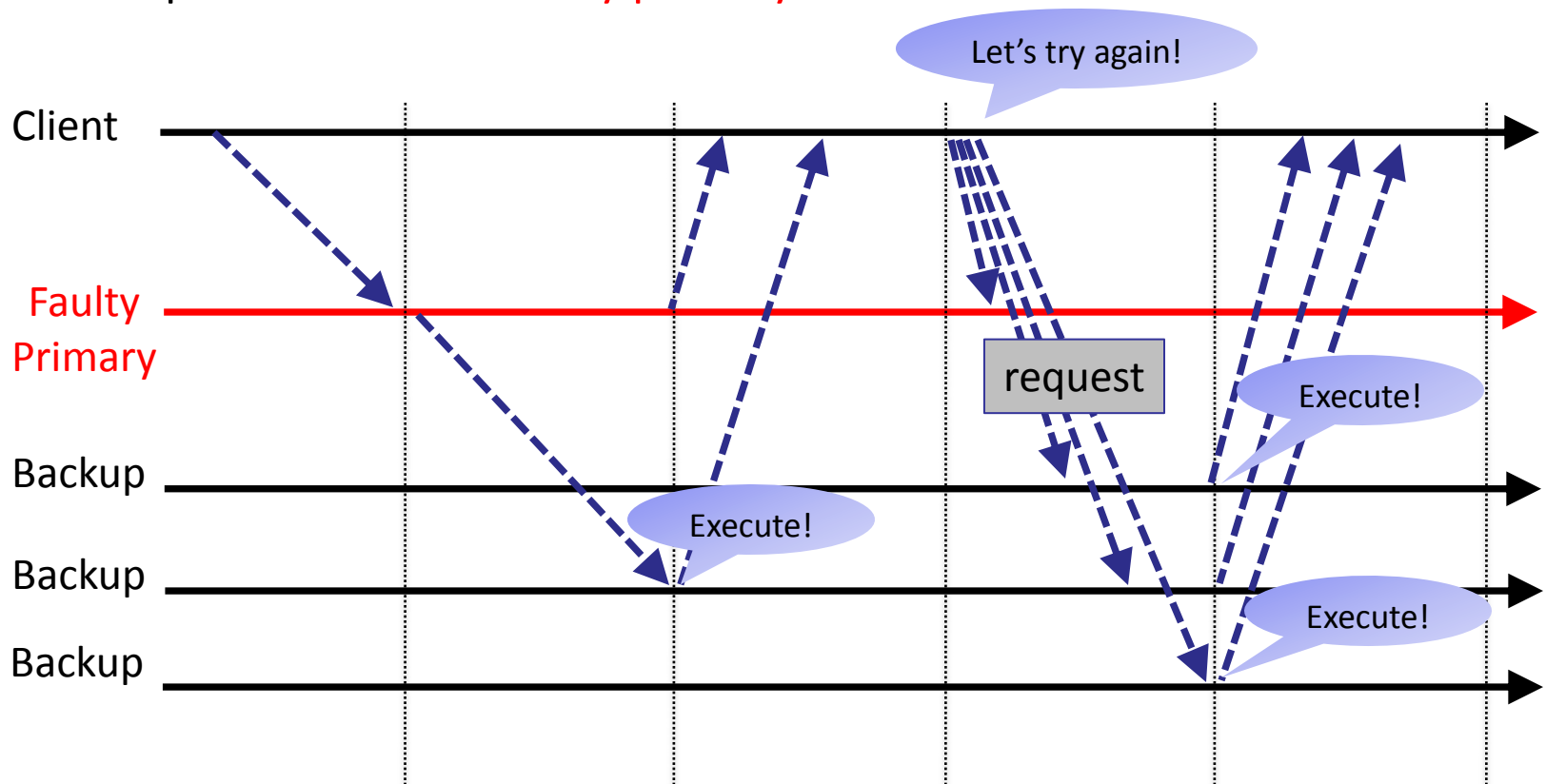

# Zyzyva

- Case 4: The client receives results that indicate an **inconsistent** ordering by the **primary**
- The client can generate a proof and append it to a view change message!

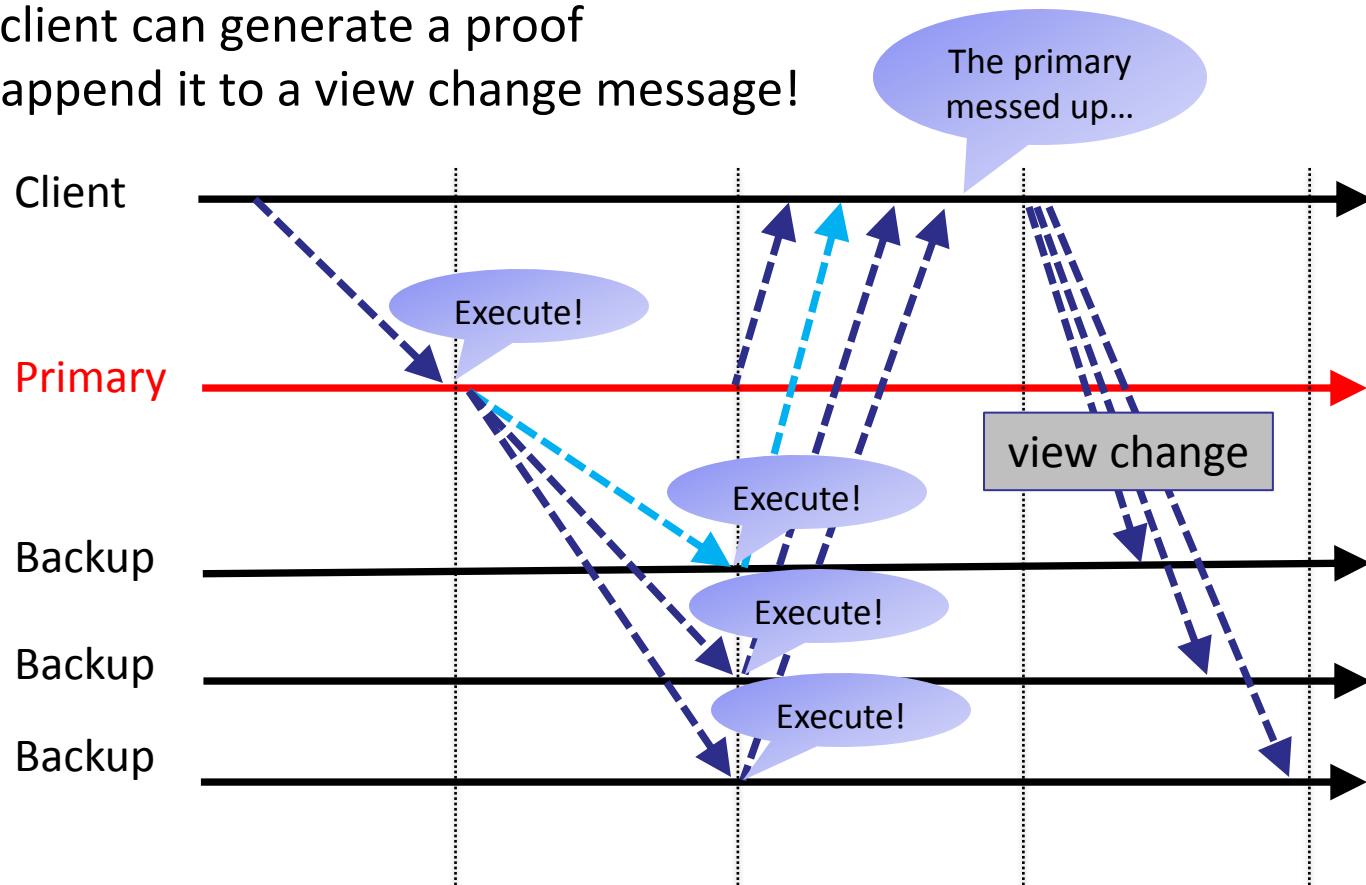

# Zyzyva: Evaluation

- Zyzyva outperforms PBFT because it normally takes only 3 rounds!

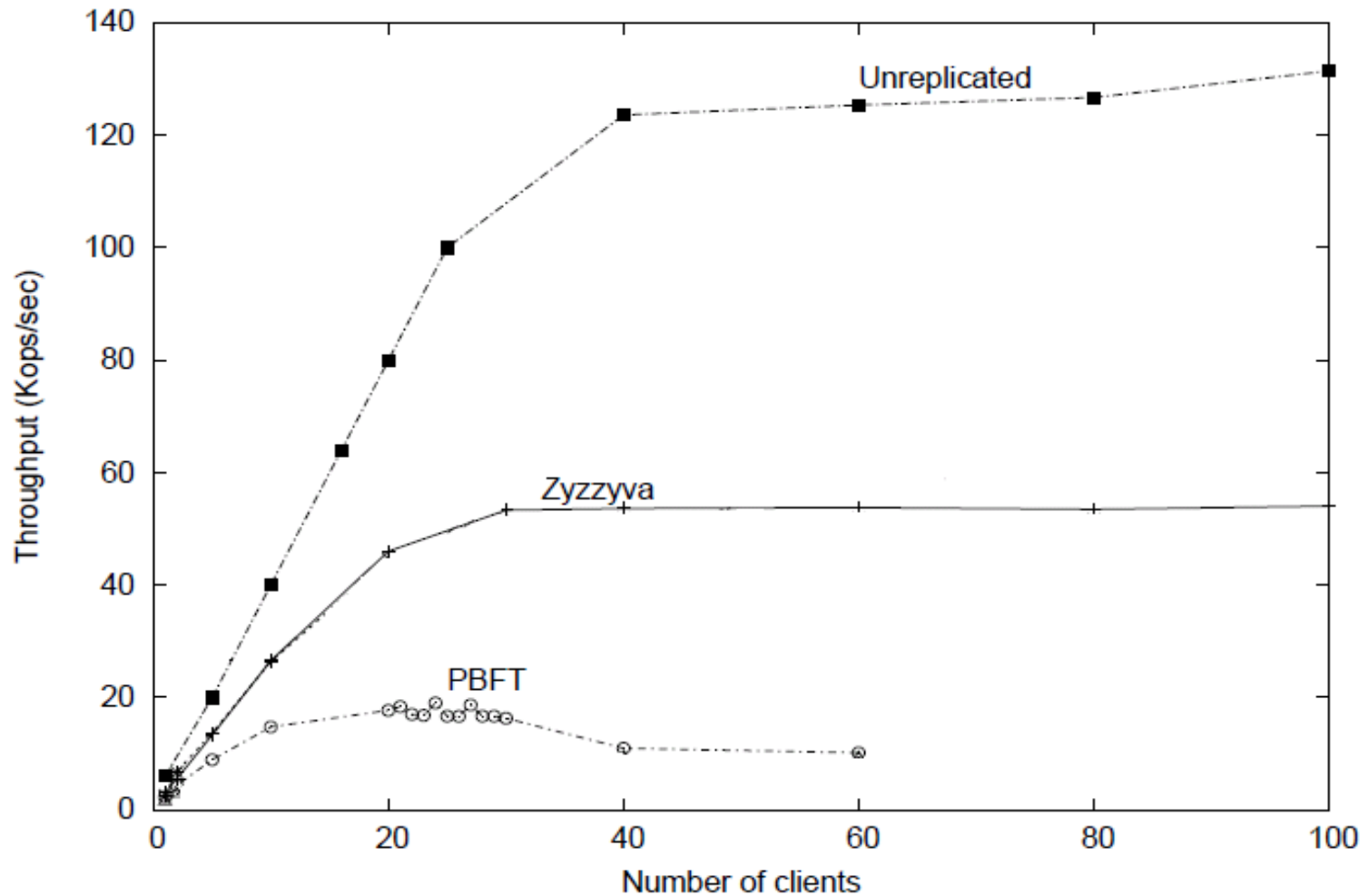

# More BFT Systems in a Nutshell: PeerReview

- The goal of PeerReview is to provide accountability for distributed systems
  - All nodes store I/O events, including all messages, in a local log
  - Selected nodes (“**witnesses**”) are responsible for auditing the log
  - If the **witnesses** detect misbehavior, they generate **evidence** and make the **evidence** available
  - Other nodes check the **evidence** and report the fault
- What if a node tries to manipulate its log entries?
  - Log entries form a **hash chain** creating **secure histories**

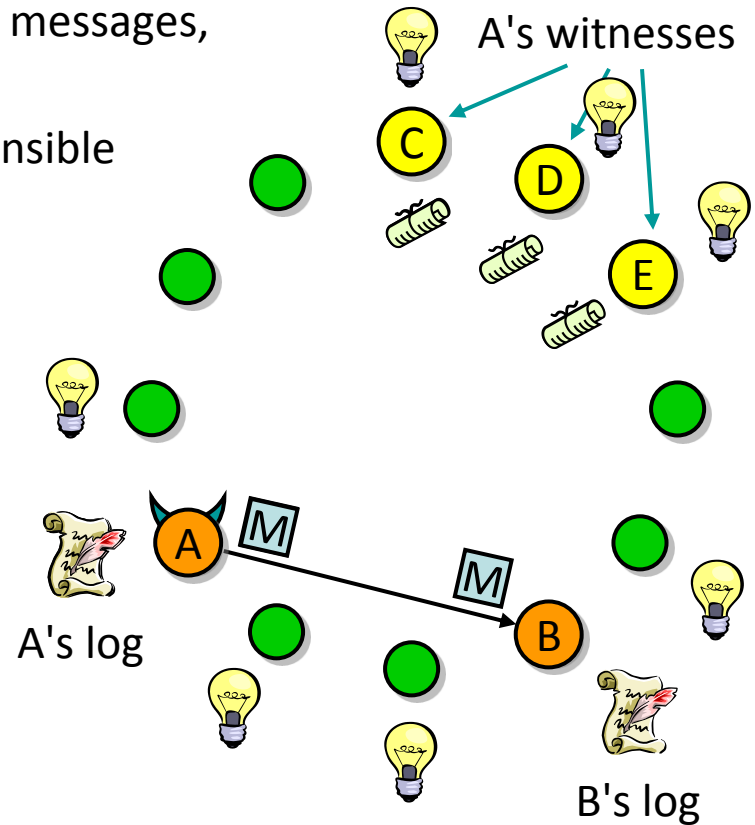

# More BFT Systems in a Nutshell: PeerReview

- PeerReview has to solve the same problems...
  - Byzantine nodes must not be able to convince correct nodes that another correct node is faulty
  - The witness sets must always contain at least one correct node
- PeerReview provides the following guarantees:
  1. Faults will be detected
    - If a node commits a fault and it has a correct witness, then the witness obtains a proof of misbehavior or a challenge that the faulty node cannot answer
  2. Correct nodes cannot be accused
    - If a node is correct, then there cannot be a correct proof of misbehavior and it can answer any challenge

## More BFT Systems in a Nutshell: FARSITE

- “**Federated, Available, and Reliable Storage for an Incompletely Trusted Environment**”
- Distributed file system without servers
- Clients contribute part of their hard disk to FARSITE
- Resistant against attacks: It tolerates  $f < n/3$  Byzantine clients
- Files
  - $f+1$  replicas per file to tolerate  $f$  failures
  - Encrypted by the user
- Meta-data/Directories
  - $3f+1$  replicas store meta-data of the files
  - File content hash in meta-data allows verification
  - How is consistency established? FARSITE uses **PBFT!**



More efficient  
than replicating  
the files!



How to make sites responsive?

# Goals of Replication

- Fault-Tolerance
  - That's what we have been looking at so far...
  - Databases
  - We want to have a system that looks like a single node, but can tolerate node failures, etc.
  - Consistency is important („better fail the whole system than giving up consistency!“)
- Performance
  - Single server cannot cope with millions of client requests per second
  - Large systems use replication to distribute load
  - Availability is important (that's a major reason why we have replicated the system...)
  - Can we relax the notion of consistency?



# Example: Bookstore

Consider a Bookstore which sells it's books over the world wide web:

What should the system provide?

- **Consistency**  
For each user the system behaves reliable
- **Availability**  
If a user clicks on a book in order to put it in his shopping cart, the user does not have to wait for the system to respond.
- **Partition Tolerance**  
If the European and the American Datacenter lose contact, the system should still operate.



How would **you** do that?

# CAP-Theorem

## Theorem

It is impossible for a distributed computer system to simultaneously provide **C**onsistency, **A**vailability and **P**artition Tolerance. A distributed system can satisfy any two of these guarantees at the same time but not all three.

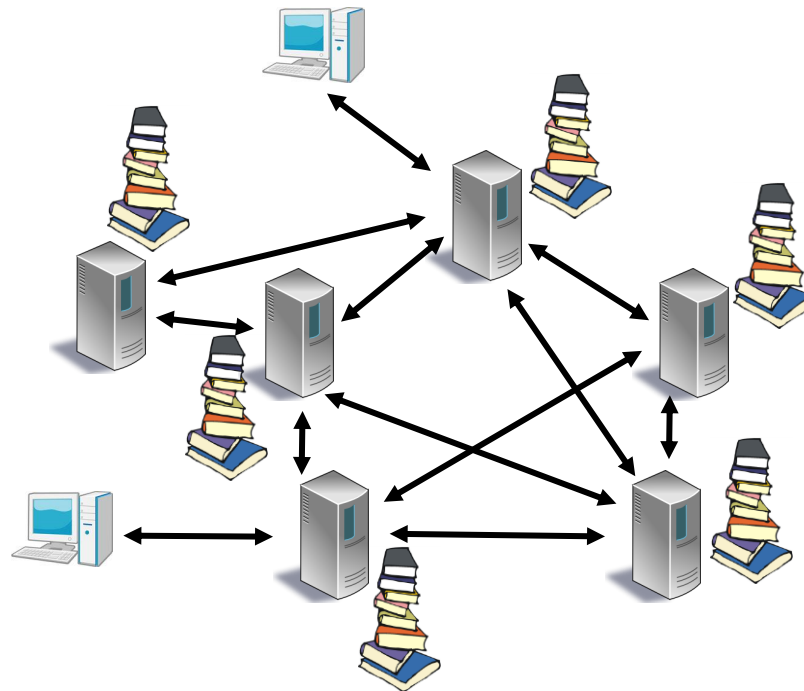

# CAP-Theorem: Proof

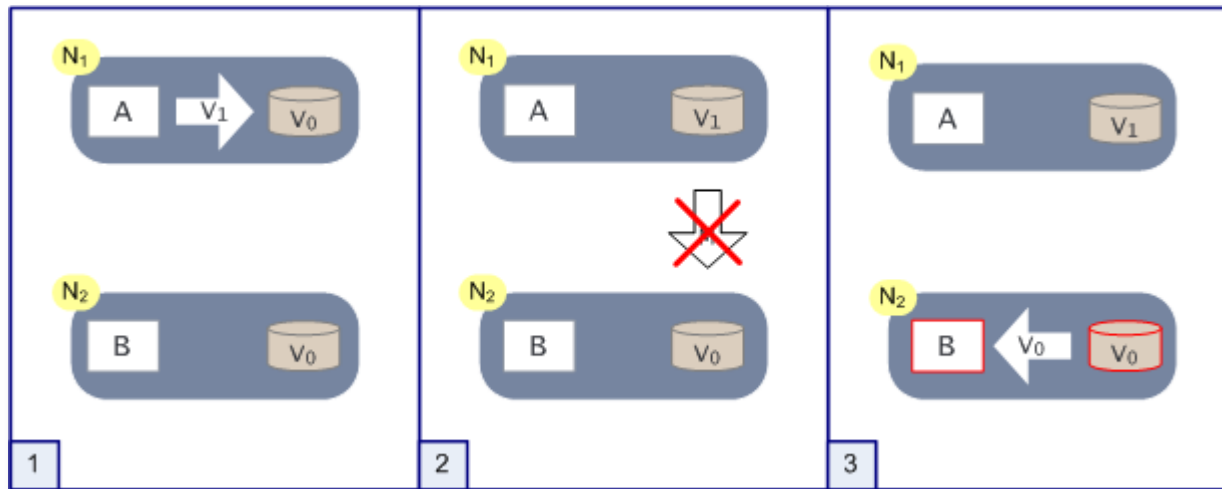

- $N_1$  and  $N_2$  are networks which both share a piece of data  $v$ .
- Algorithm A writes data to  $v$  and algorithm B reads data from  $v$ .
- If a partition between  $N_1$  and  $N_2$  occurs, there is no way to ensure consistency and availability: Either A and B have to wait for each other before finishing (so availability is not guaranteed) or inconsistencies will occur.

# CAP-Theorem: Consequences

## Partition



### Drop Availability

Wait until data is consistent and therefore remain unavailable during that time.

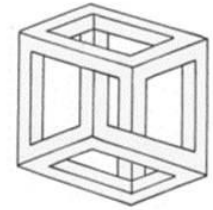

### Drop Consistency

Accept that things will become „Eventually consistent“  
(e.g. bookstore: If two orders for the same book were received, one of the clients becomes a back-order)

Again, what would you prefer?

amazon.com<sup>®</sup>

**Availability is more  
important than consistency!**

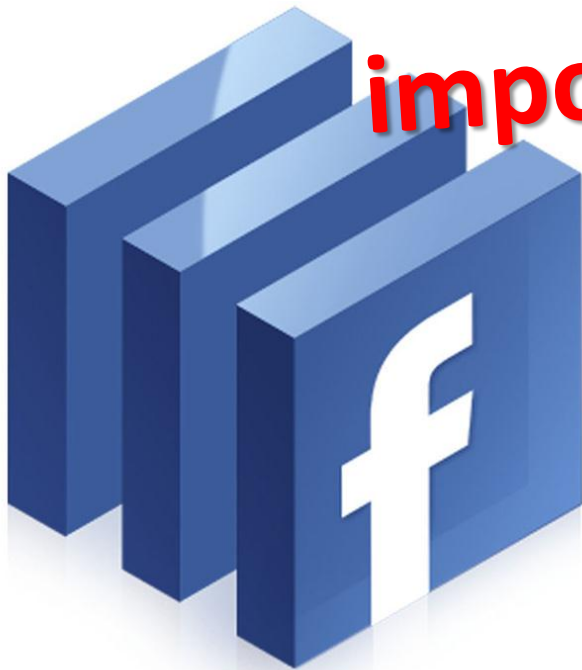

Google<sup>™</sup>

```
*****
A problem has been detected and Windows has been notified to attempt to
correct the error. If you are the first time you've seen this error screen,
restart your computer. If the screen appears again, follow
these steps:
Check to be sure you have adequate disk space. If a driver is
corruptive to the CD-ROM drive, CD-RW or DVD drive or other
removable media device, remove the media and restart.
Check your hardware vendor for any BIOS updates. Upgrade
your BIOS before updating software or hardware. If you need
to use safe mode to remove or replace components, restart your
computer, press F8 to select Advanced Startup Options, and then
select Safe Mode.
Additional information:
*** ERROR: HRESULT: 0xc0000142, 0x00000000, 0x00000000, 0x00000000
*** HRESULT: 0x0 - Address 0x00000000 base or 0x00000000, 0x00000000
Recovering some physical memory
Physical memory was corrupted.
Contact your system administrator or technical support group for further
assistance.*****
```

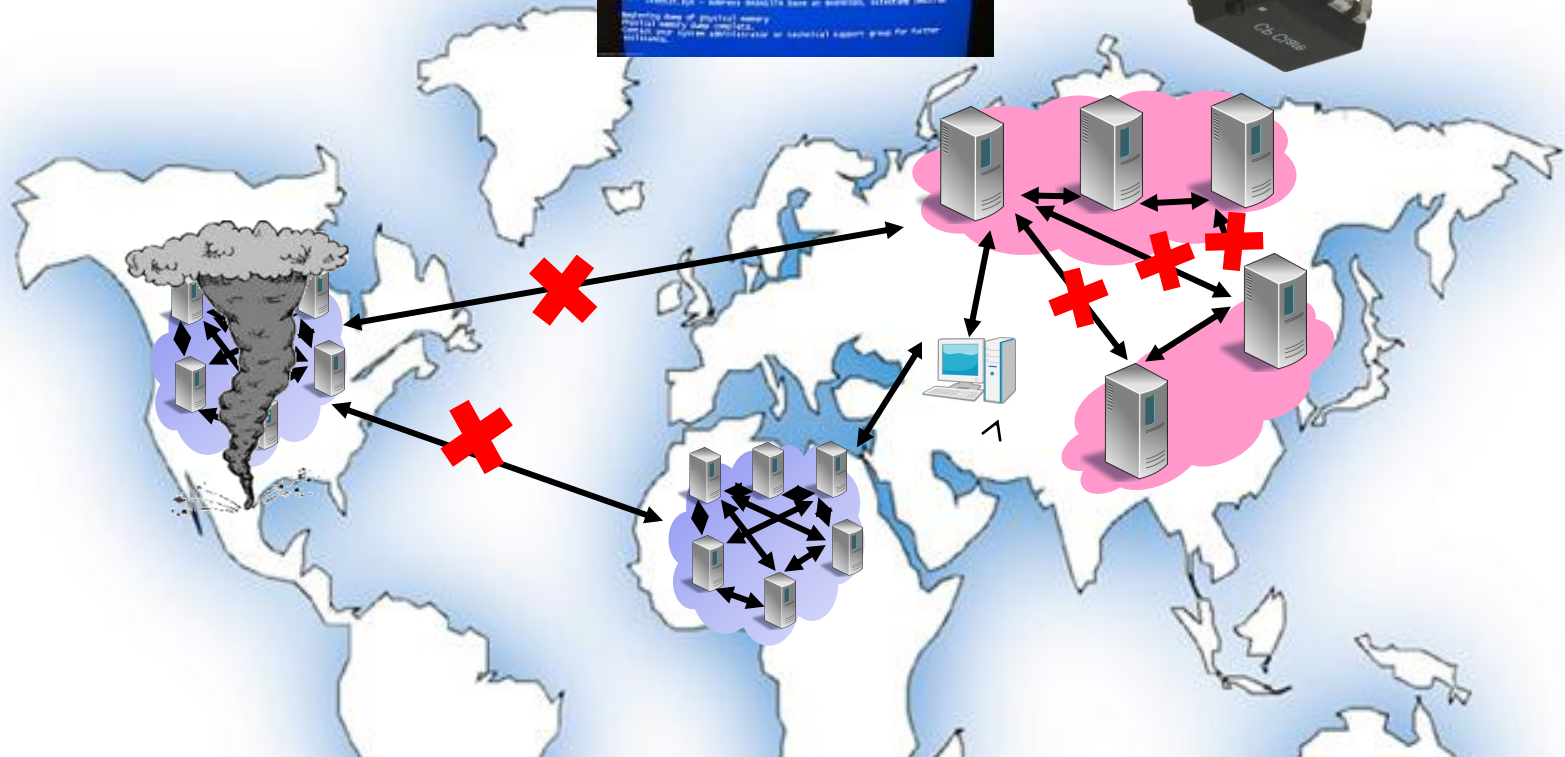

**distrib.exe - Application Error**

 The application failed to initialize properly (0xc0000142). Click on OK to terminate the application.



# CAP-Theorem: Criticism

- Application Errors
- Repeatable DBMS errors
- A disaster (local cluster wiped out)

CAP-Theorem does not apply

- Unrepeatable DBMS errors
- Operating system errors
- Hardware failure in local cluster
- A network partition in a local cluster

Mostly cause a single node to fail  
(can be seen as a degenerated case  
of a network partition)

This is easily survived by lots of  
algorithms

- Network failure in the WAN

Very rare!

Conclusion: Better giving up availability than sacrificing consistency

# ACID and BASE

## ACID

- **Atomicity:** All or Nothing: Either a transaction is processed in its entirety or not at all
- **Consistency:** The database remains in a consistent state
- **Isolation:** Data from transactions which are not yet completed cannot be read by other transactions
- **Durability:** If a transaction was successful it stays in the System (even if system failures occur)

## BASE

- **Basically Available**
- **Soft State**
- **Eventually consistent**

BASE is a counter concept to ACID.

The system may be in an inconsistent state, but will eventually become consistent.



# ACID vs. BASE

## ACID

- Strong consistency
- Pessimistic
- Focus on commit
- Isolation
- Difficult schema evolution



## BASE

- Weak consistency
- Optimistic
- Focus on availability
- Best effort
- Flexible schema evolution
- Approximate answers okay
- Faster
- Simpler?

# Consistency Models (Client View)

- **Interface** that describes the system behavior
- Recall: Strong consistency
  - After an update of process A completes, any subsequent access (by A, B, C, etc.) will return the updated value.
- Weak consistency
  - Goal: Guarantee availability and some „reasonable amount“ of consistency!
  - System does not guarantee that subsequent accesses will return the updated value.

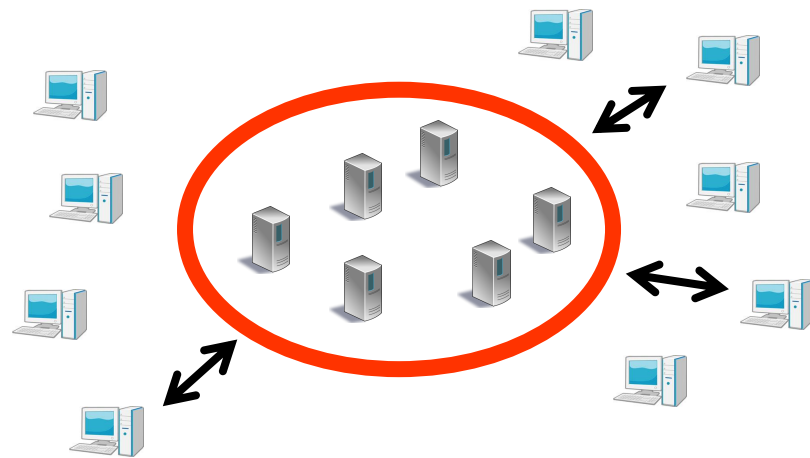

What kind of guarantees would you definitely expect from a real-world storage system?

Libraries > Pictures > ACM\_MM2010

Search ACM\_MM2010

Organize Preview Share with Slide show Print E-mail Burn New folder

**Pictures library**  
ACM\_MM2010

Arrange by: Folder

20101024\_009b.jpg

20101024\_011h.jpg

P1000863.JPG

P1000864.JPG

P1000865.JPG

P1000866.JPG

P1000867.JPG

P1000868.JPG

P1000869.JPG

P1000870.JPG

P1000871.JPG

P1000872.JPG

P1000873.JPG

P1000874.JPG

P1000875.JPG

P1000876.JPG

P1000877.JPG

P1000878.JPG

P1000879.JPG

P1000880.JPG

P1000881.JPG

P1000882.JPG

P1000883.JPG

P1000884.JPG

P1000885.JPG

P1000886.JPG

P1000887.JPG

P1000888.JPG

P1000889.JPG

P1000890.JPG

P1000891.JPG

P1000892.JPG

P1000893.JPG

P1000894.JPG

P1000895.JPG

20101024\_009b.jpg Date taken: Specify date taken  
 Rating: ☆☆☆☆☆  
 Dimensions: 800 x 480  
 Size: 171 KB  
 Tags: Add a tag

# Examples of Guarantees we might not want to sacrifice...

- If I write something to the storage, I want to see the result on a subsequent read.
- If I perform two read operations on the same variable, the value returned at the second read should be at least as new as the value returned by the first read.
- Known data-dependencies should be reflected by the values read from the storage system.

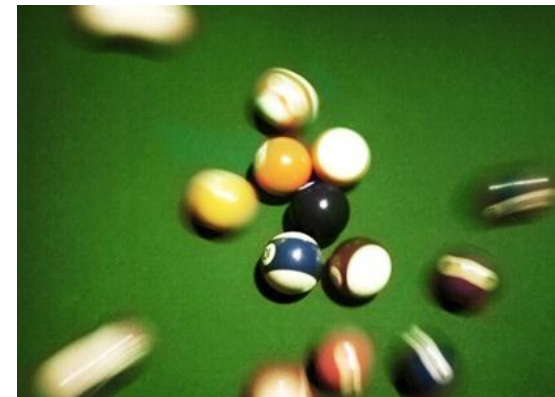
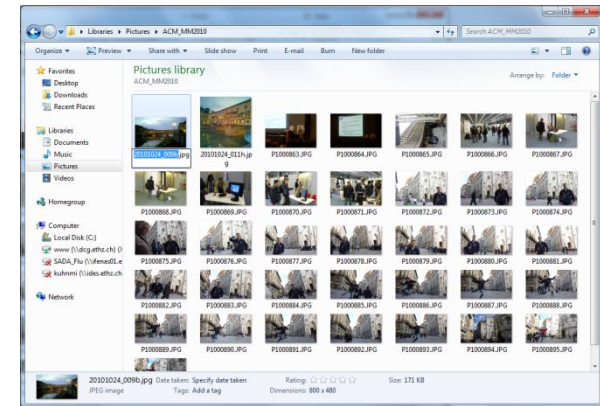

# Weak Consistency

- A considerable **performance gain** can result if messages are transmitted independently, and applied to each replica whenever they arrive.
  - But: Clients can see **inconsistencies** that would never happen with unreplicated data.

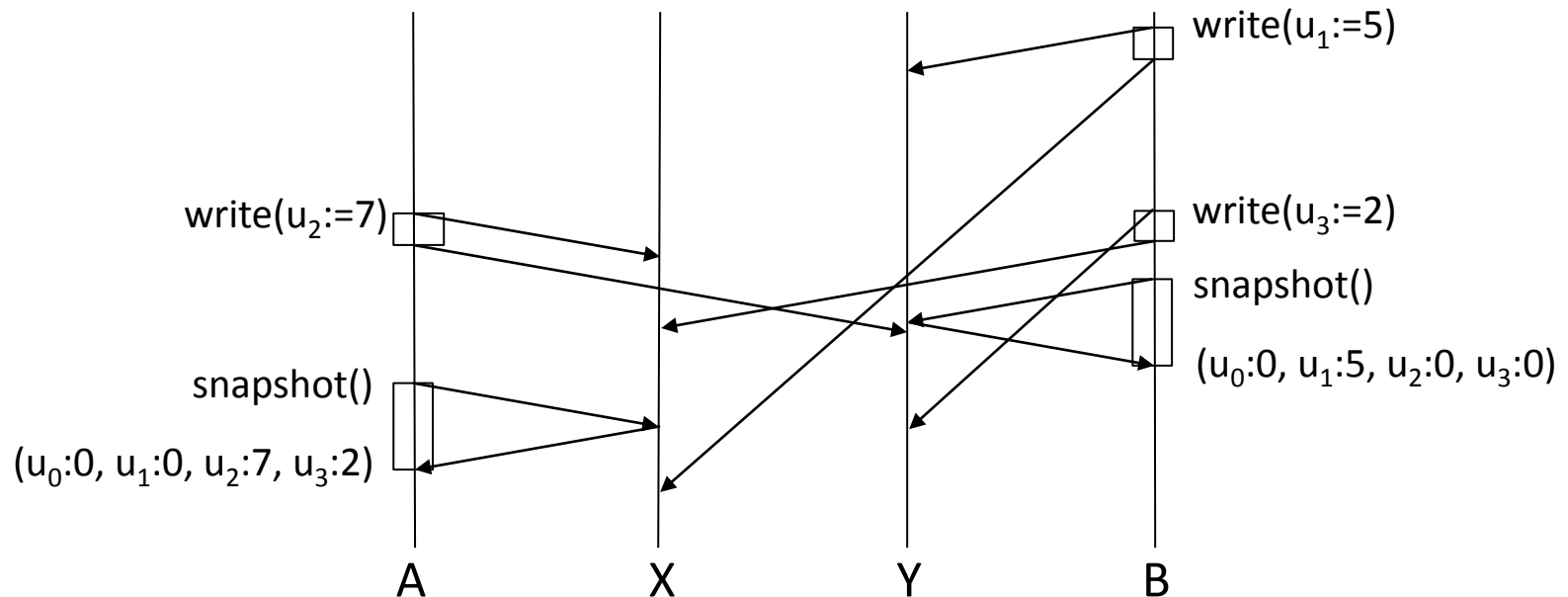

This execution is NOT sequentially consistent

# Weak Consistency: Eventual Consistency

## Definition

### Eventual Consistency

If no new updates are made to the data object, eventually all accesses will return the last updated value.

- Special form of weak consistency
- Allows for „disconnected operation“
- Requires some **conflict resolution** mechanism
  - After conflict resolution all clients see the same order of operations up to a certain point in time („agreed past“).
  - Conflict resolution can occur on the server-side or on the client-side





# Weak Consistency: More Concepts

## Definition

### Monotonic Read Consistency

If a process has seen a particular value for the object, any subsequent accesses will never return any previous values.

## Definition

### Monotonic Write Consistency

A write operation by a process on a data item  $u$  is completed before any successive write operation on  $u$  by the same process (i.e. system guarantees to serialize writes by the same process).

## Definition

### Read-your-Writes Consistency

After a process has updated a data item, it will never see an older value on subsequent accesses.

# Weak Consistency: Causal Consistency

## Definition

A system provides **causal consistency** if memory operations that potentially are *causally related* are seen by every node of the system in the same order. Concurrent writes (i.e. ones that are not causally related) may be seen in different order by different nodes.

## Definition

The following pairs of operations are **causally related**:

- Two writes by the same process to any memory location.
- A read followed by a write of the same process (even if the write addresses a different memory location).
- A read that returns the value of a write from any process.
- Two operations that are transitively related according to the above conditions.

# Causal Consistency: Example

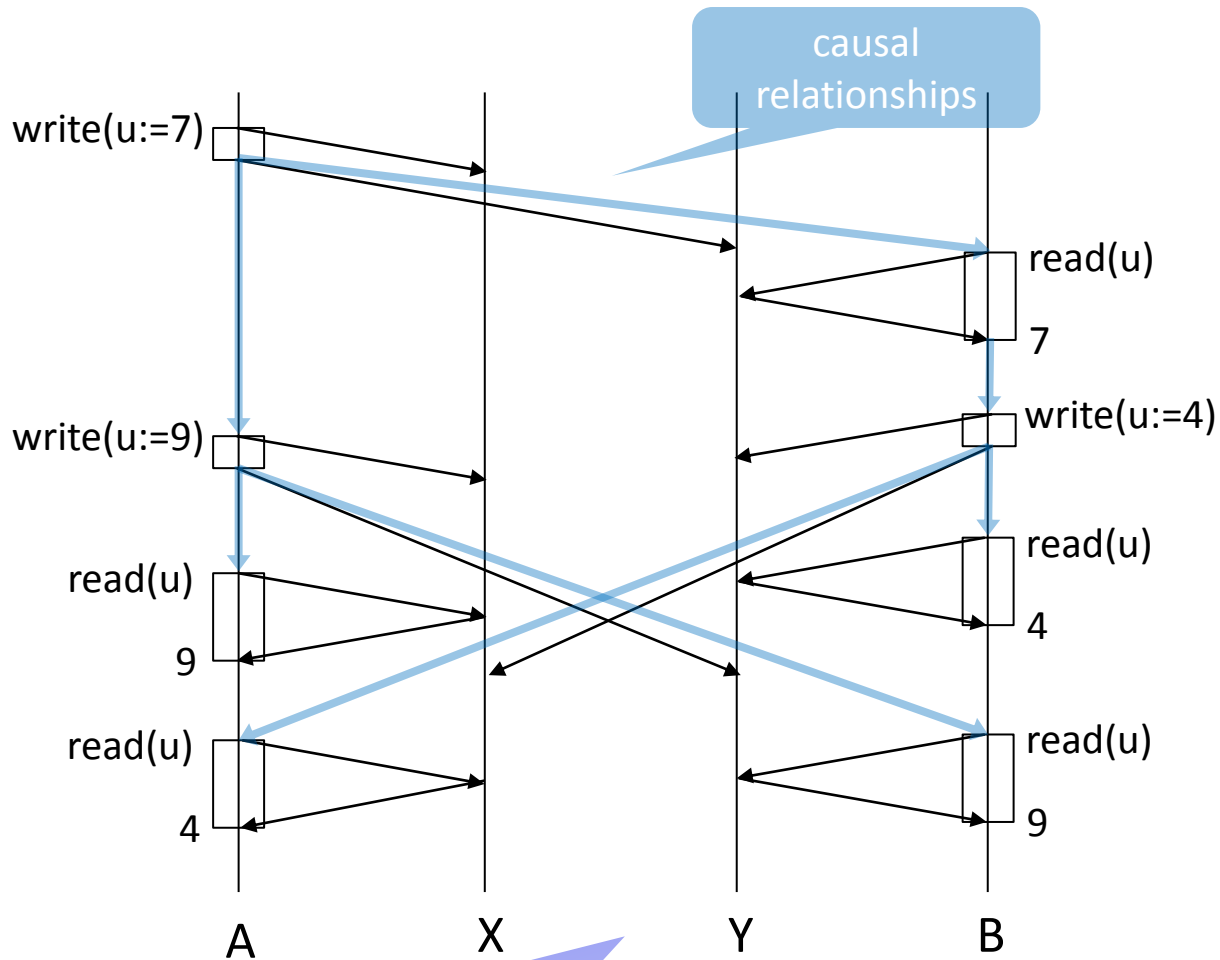

This execution is causally consistent, but NOT sequentially consistent

# Large-Scale Fault-Tolerant Systems

- How do we build these highly available, fault-tolerant systems consisting of 1k, 10k,..., 1M nodes?
- Idea: Use a completely decentralized system, with a focus on availability, only giving weak consistency guarantees. This general approach has been popular recently, and is known as, e.g.
  - Cloud Computing: Currently popular umbrella name
  - Grid Computing: Parallel computing beyond a single cluster
  - Distributed Storage: Focus on storage
  - Peer-to-Peer Computing: Focus on storage, affinity with file sharing
  - Overlay Networking: Focus on network applications
  - Self-Organization, Service-Oriented Computing, Autonomous Computing, etc.
- Technically, many of these systems are similar, so we focus on one.

# P2P: Distributed Hash Table (DHT)

- Data objects are distributed among the peers
  - Each object is uniquely identified by a **key**
- Each peer can perform certain operations
  - Search(**key**) (returns the object associated with key)
  - Insert(**key**, object)
  - Delete(**key**)
- Classic implementations of these operations
  - Search Tree (balanced, B-Tree)
  - Hashing (various forms)
- “Distributed” implementations
  - Linear Hashing
  - Consistent Hashing

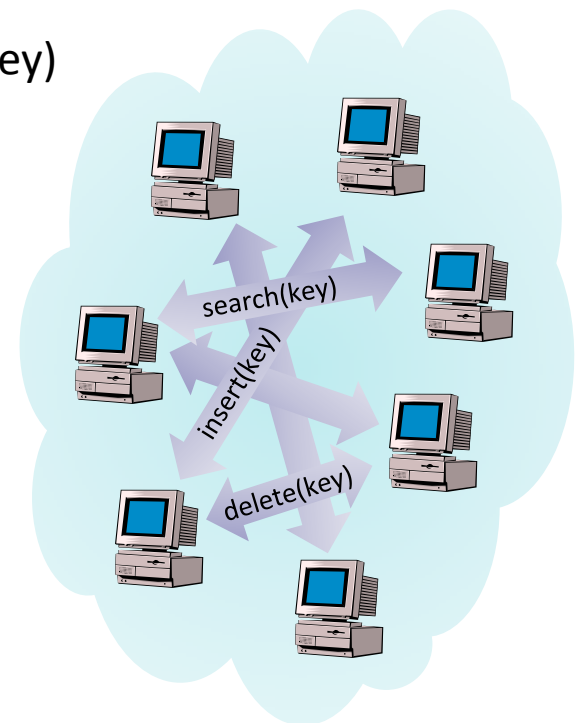

# Distributed Hashing

- The hash of a file is its key

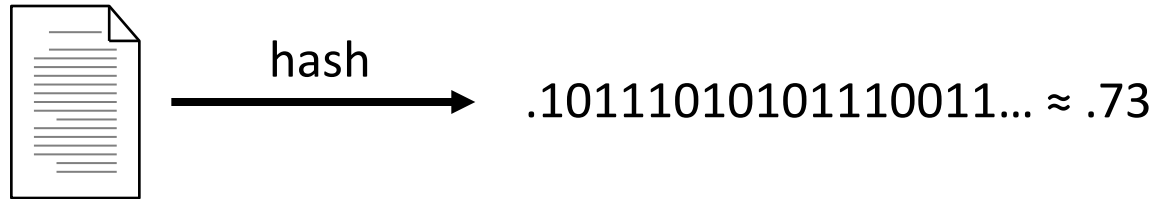

- Each peer stores data in a certain range of the ID space  $[0,1]$

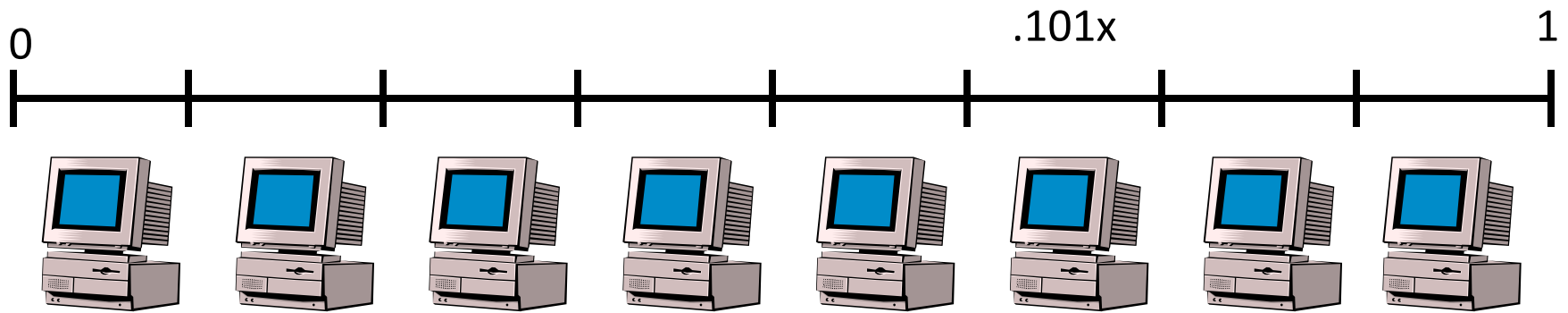

- Instead of storing data at the right peer, just store a forward-pointer

# Linear Hashing

- Problem: More and more objects should be stored → Need to buy new machines!
- Example: From 4 to 5 machines

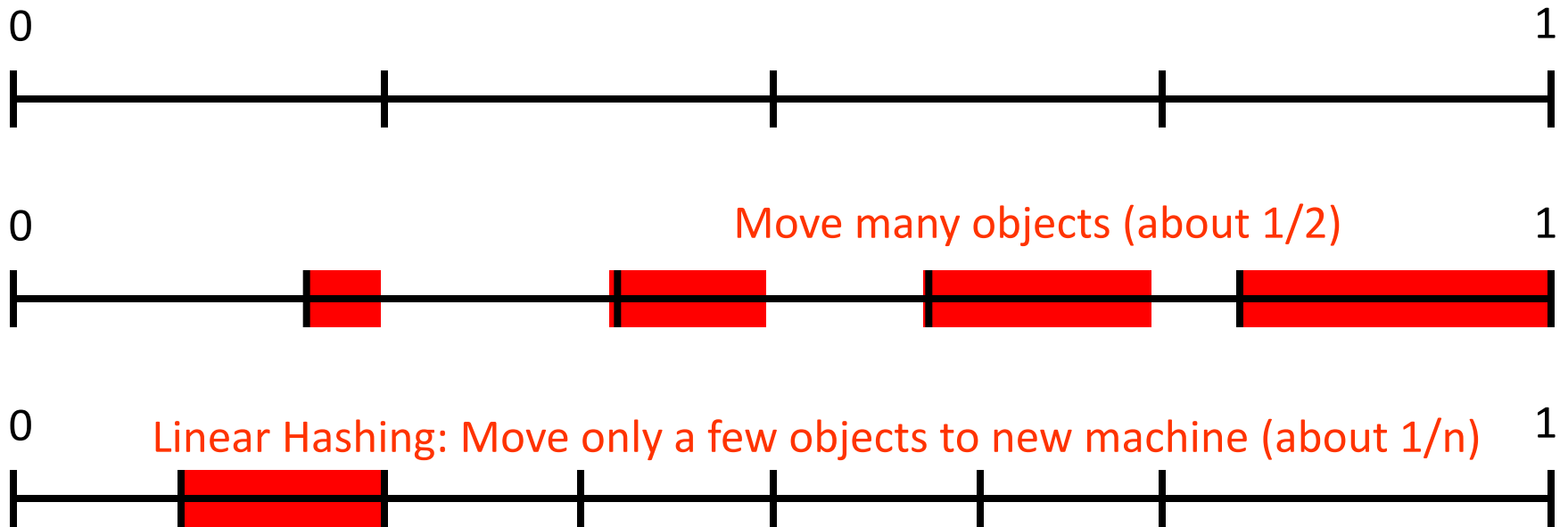

# Consistent Hashing

- Linear hashing needs central dispatcher
- Idea: Also the machines get hashed! Each machine is responsible for the files closest to it
- Use multiple hash functions for reliability!

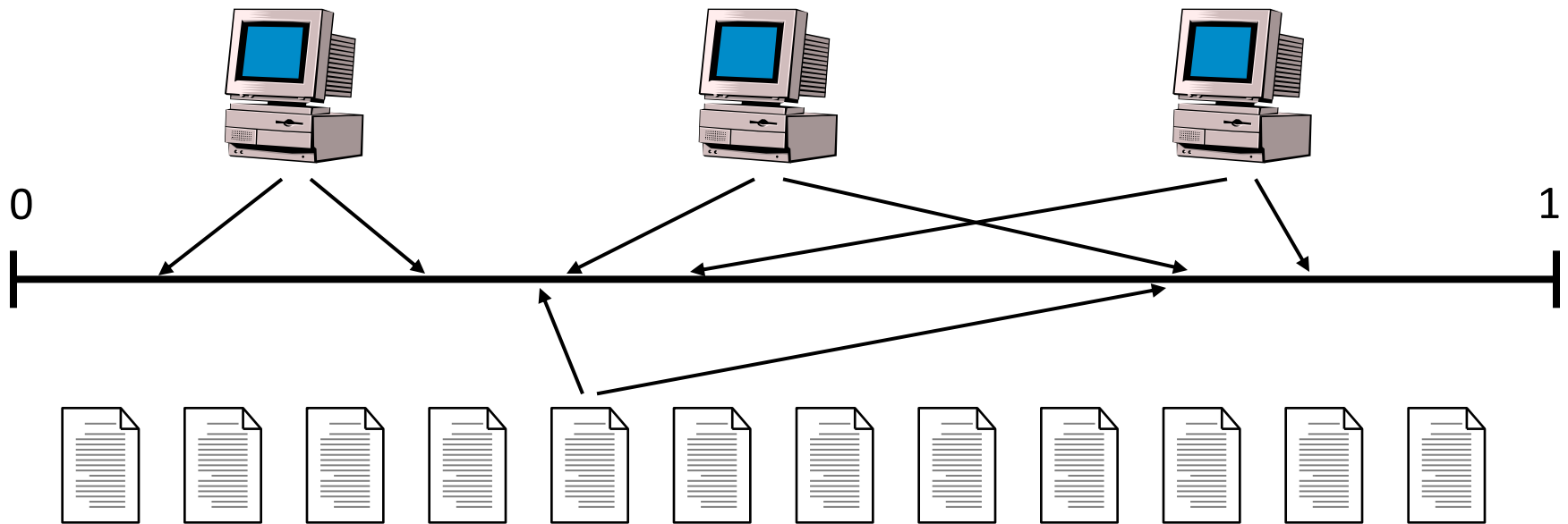



# Search & Dynamics

- Problem with both linear and consistent hashing is that all the participants of the system must know all peers...
  - Peers must know which peer they must contact for a certain data item
  - This is again not a scalable solution...
- Another problem is **dynamics**!
  - Peers join and leave (or fail)

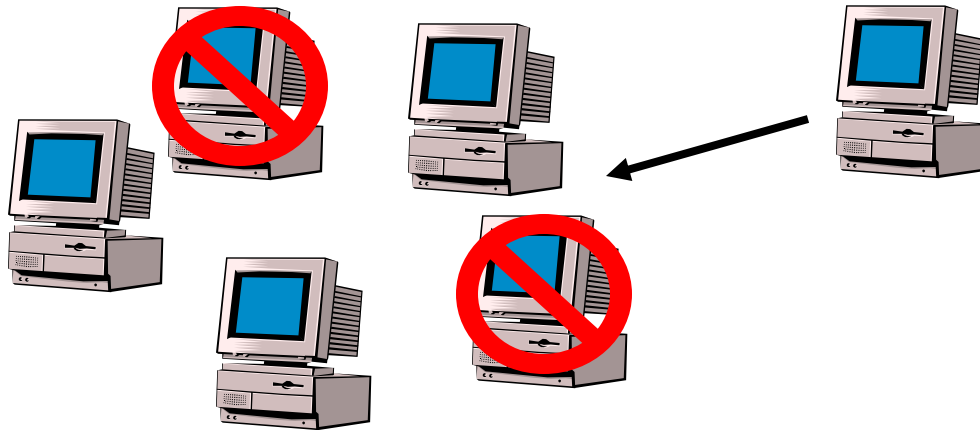

# P2P Dictionary = Hashing

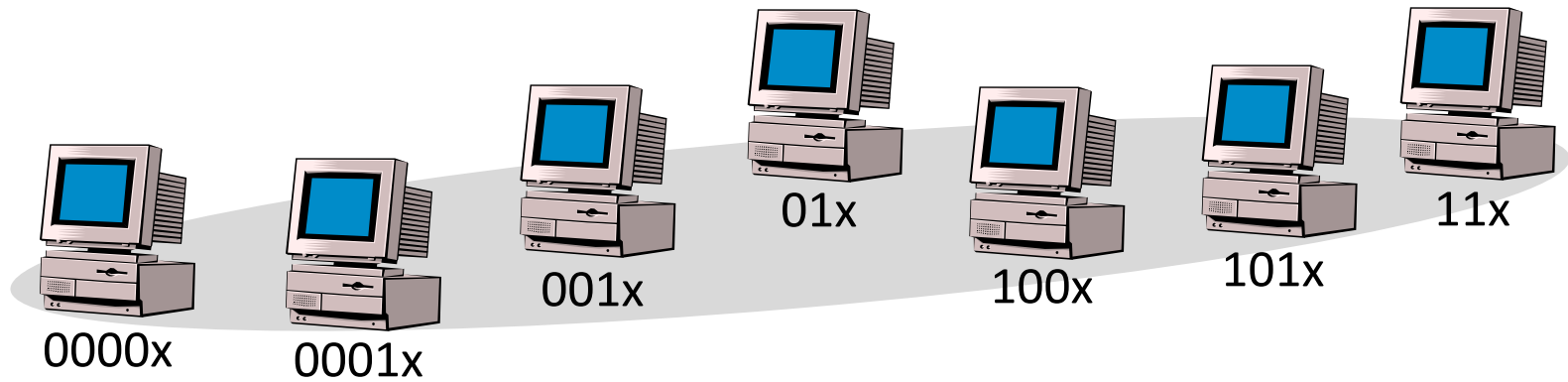
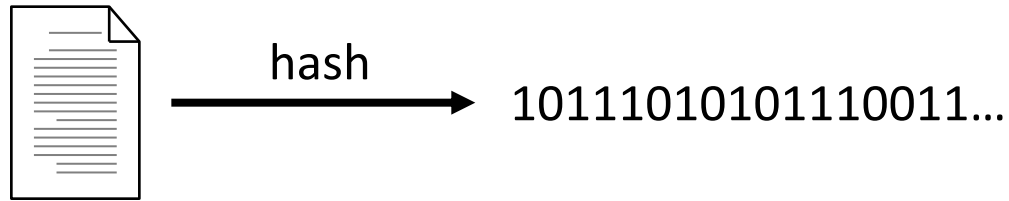

# P2P Dictionary = Search Tree

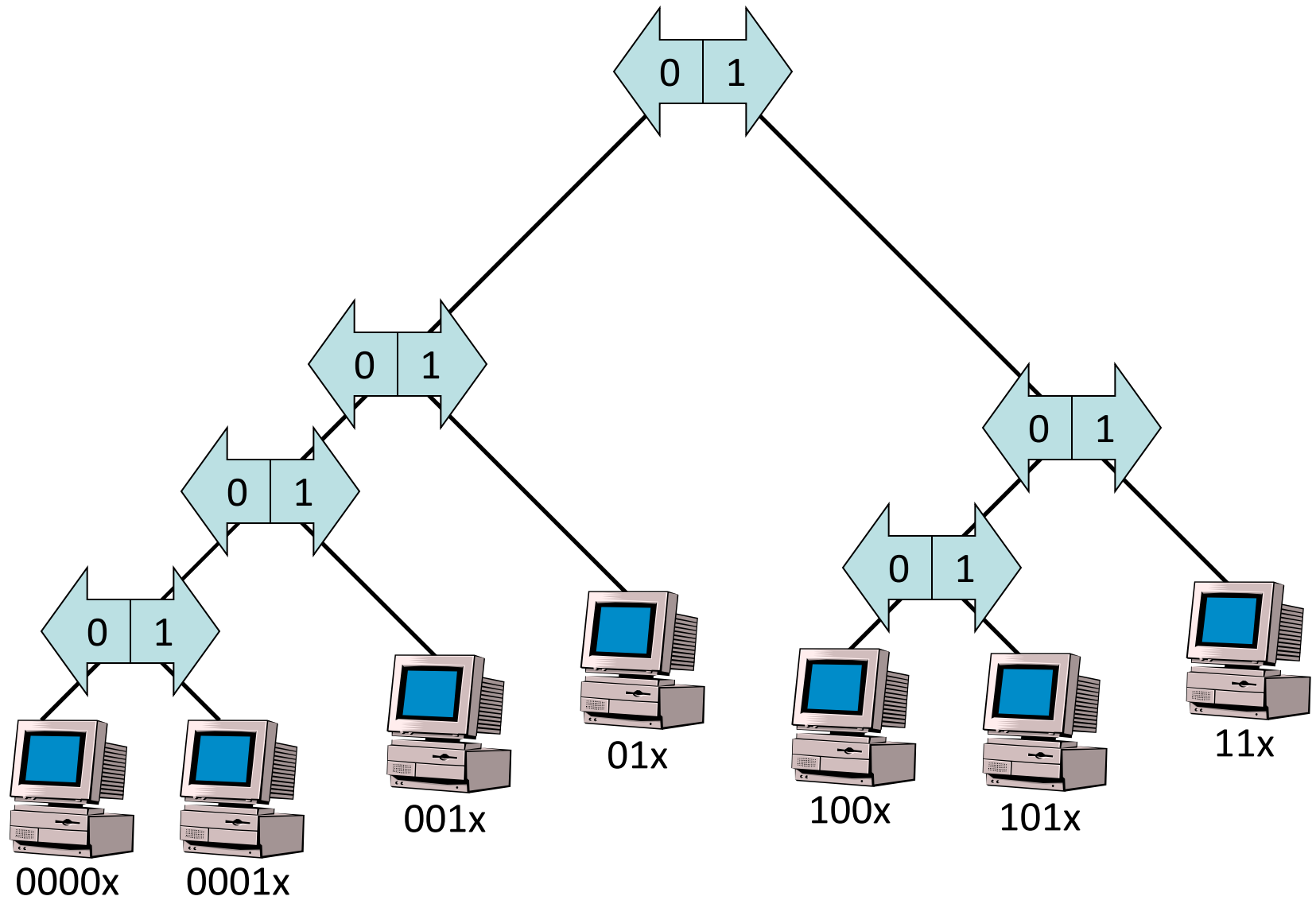

# Storing the Search Tree

- Where is the search tree stored?
- In particular, where is the **root** stored?
  - What if the root crashes?! The root clearly reduces scalability & fault tolerance...
  - Solution: There is **no root**...!
- If a peer wants to store/search, how does it know where to go?
  - Again, we don't want that every peer has to know all others...
  - Solution: Every peer only knows a **small subset** of others

# The Neighbors of Peers 001x

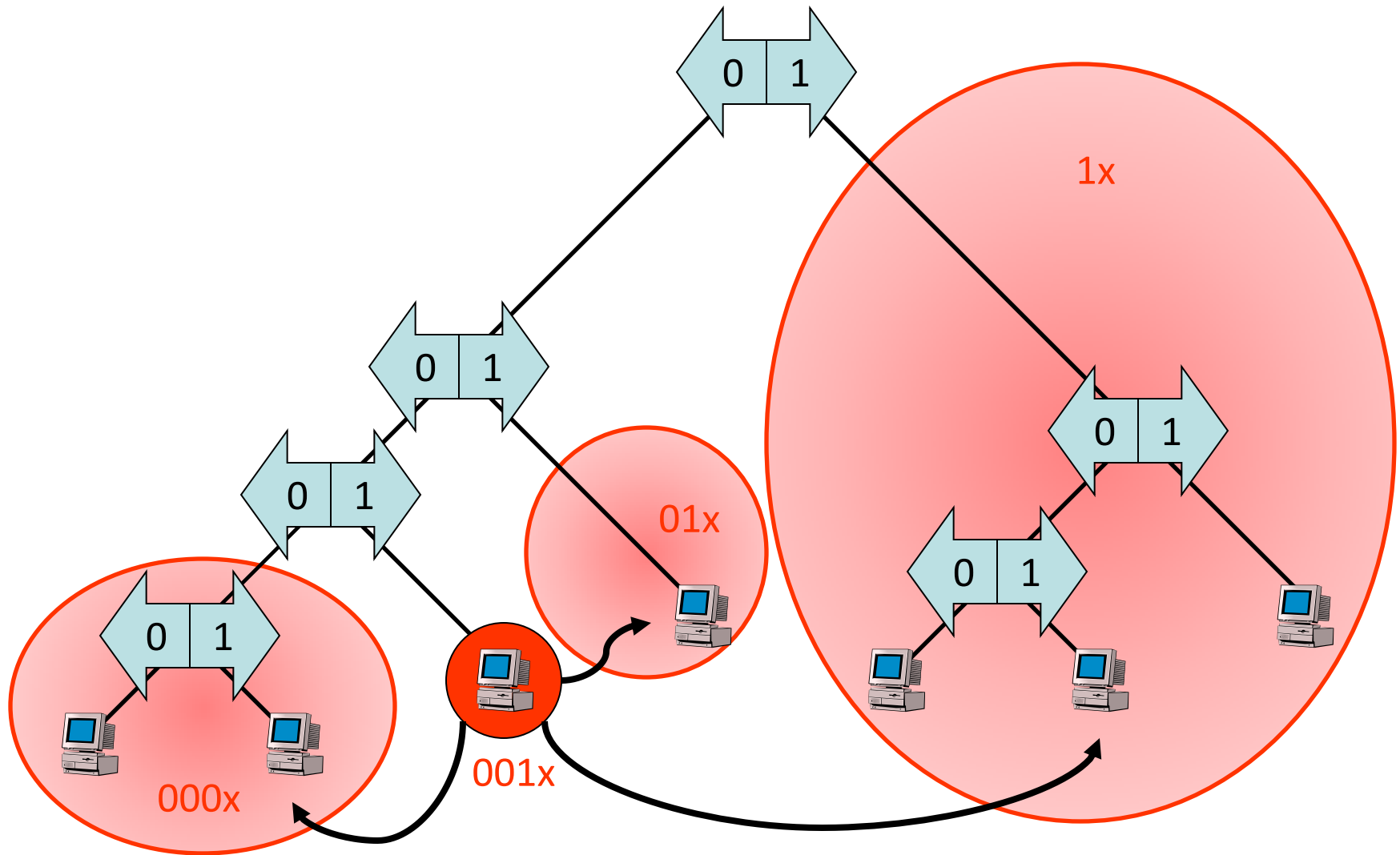

# P2P Dictionary: Search

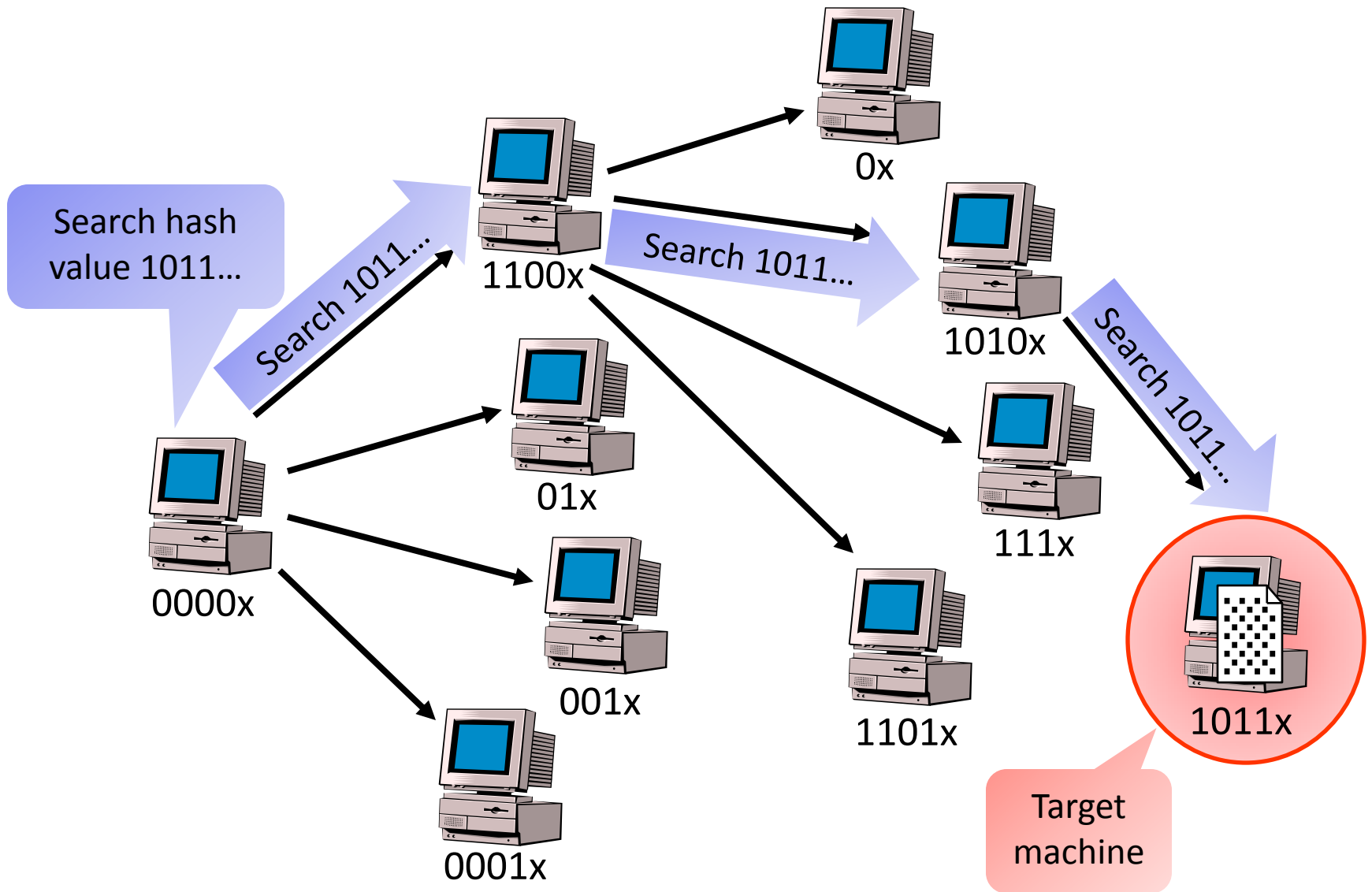

# P2P Dictionary: Search

- Again, 001 searches for 100:

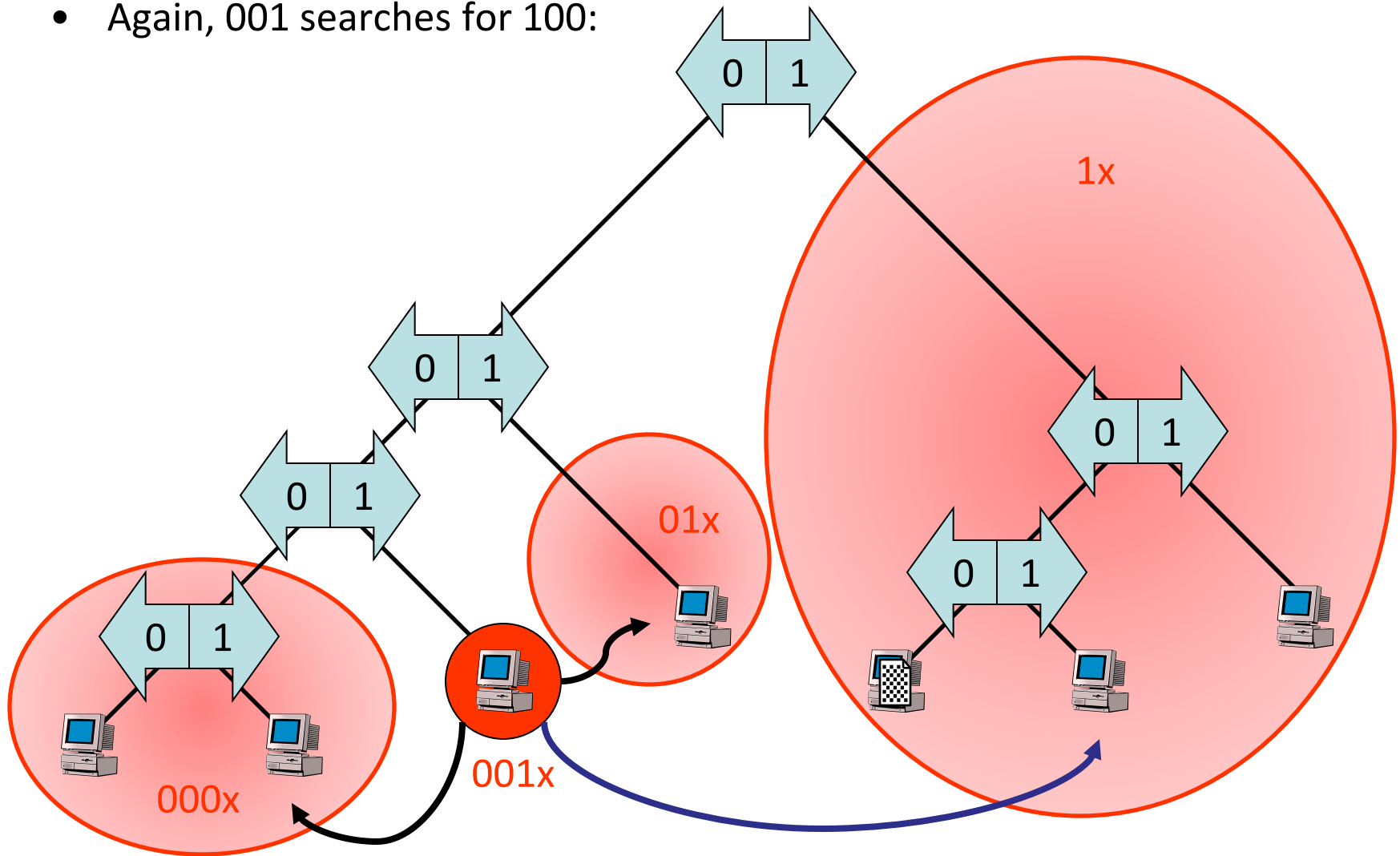

# P2P Dictionary: Search

- Again, 001 searches for 100:

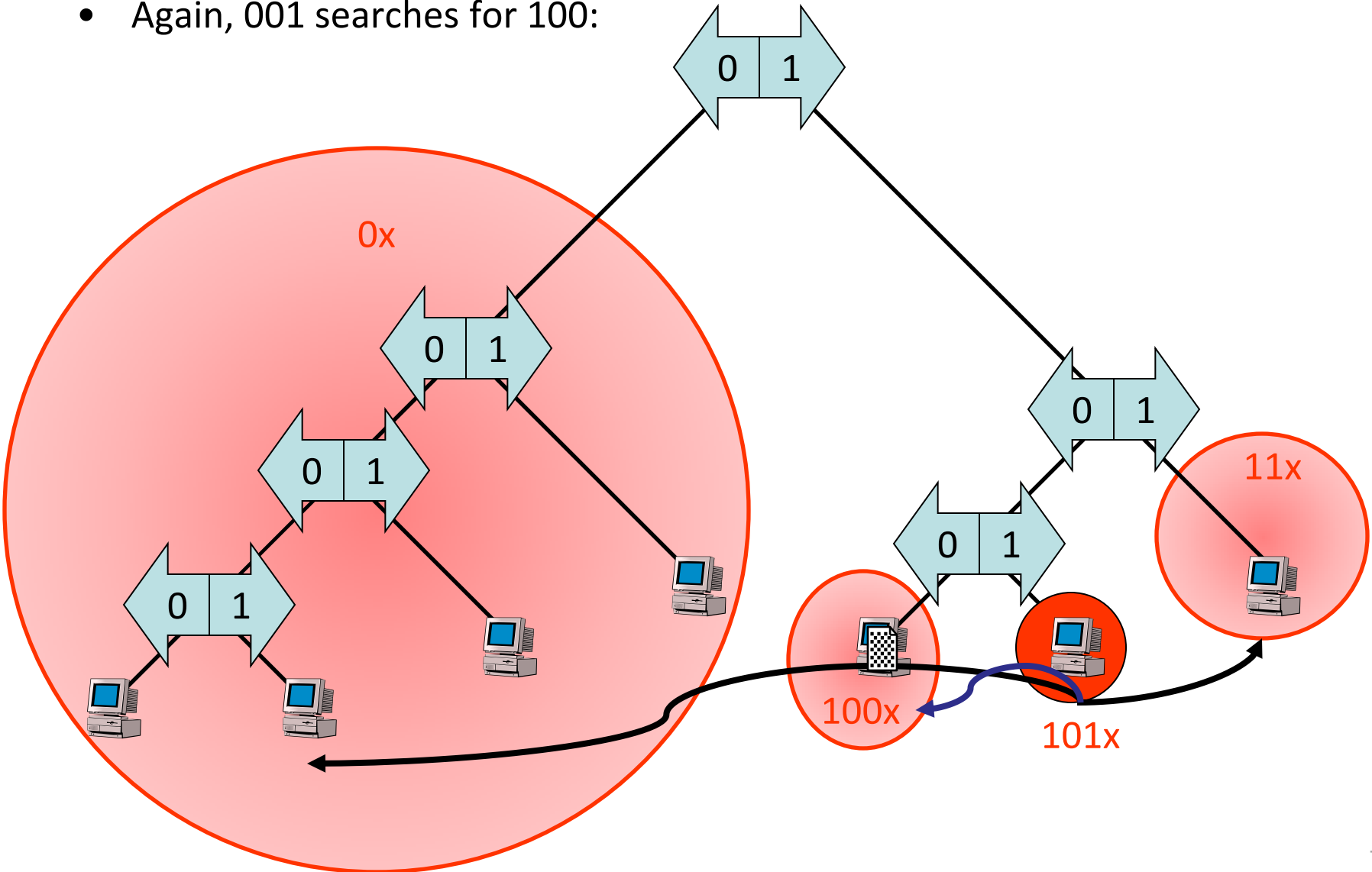



# Search Analysis

- We have  $n$  peers in the system
- Assume that the “tree” is roughly **balanced**
  - Leaves (peers) on level  $\log_2 n \pm \text{constant}$
- Search requires  **$O(\log n)$  steps**
  - After  $k^{\text{th}}$  step, the search is in a subtree on level  $k$
  - A “step” is a UDP (or TCP) message
  - The latency depends on P2P size (world!)
- How many peers does each peer have to know?
  - Each peer only needs to store the address of  $\log_2 n \pm \text{constant}$  peers
  - Since each peer only has to know a few peers, even if  $n$  is large, the system scales well!

# Peer Join

- How are new peers inserted into the system?
- Step 1: **Bootstrapping**
- In order to join a P2P system, a joiner must already know a peer already in the system
- Typical solutions:
  - Ask a central authority for a list of IP addresses that have been in the P2P regularly; look up a listing on a web site
  - Try some of those you met last time
  - Just ping randomly (in the LAN)

# Peer Join

- Step 2: **Find your place** in the P2P system
- Typical solution:
  - Choose a **random bit string** (which determines the place in the system)
  - **Search**\* for the bit string
  - **Split** with the current leave responsible for the bit string
  - **Search**\* for your neighbors

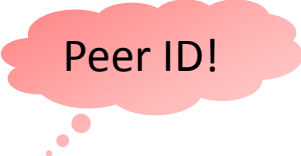

Peer ID!

\* These are standard searches

# Example: Bootstrap Peer with 001

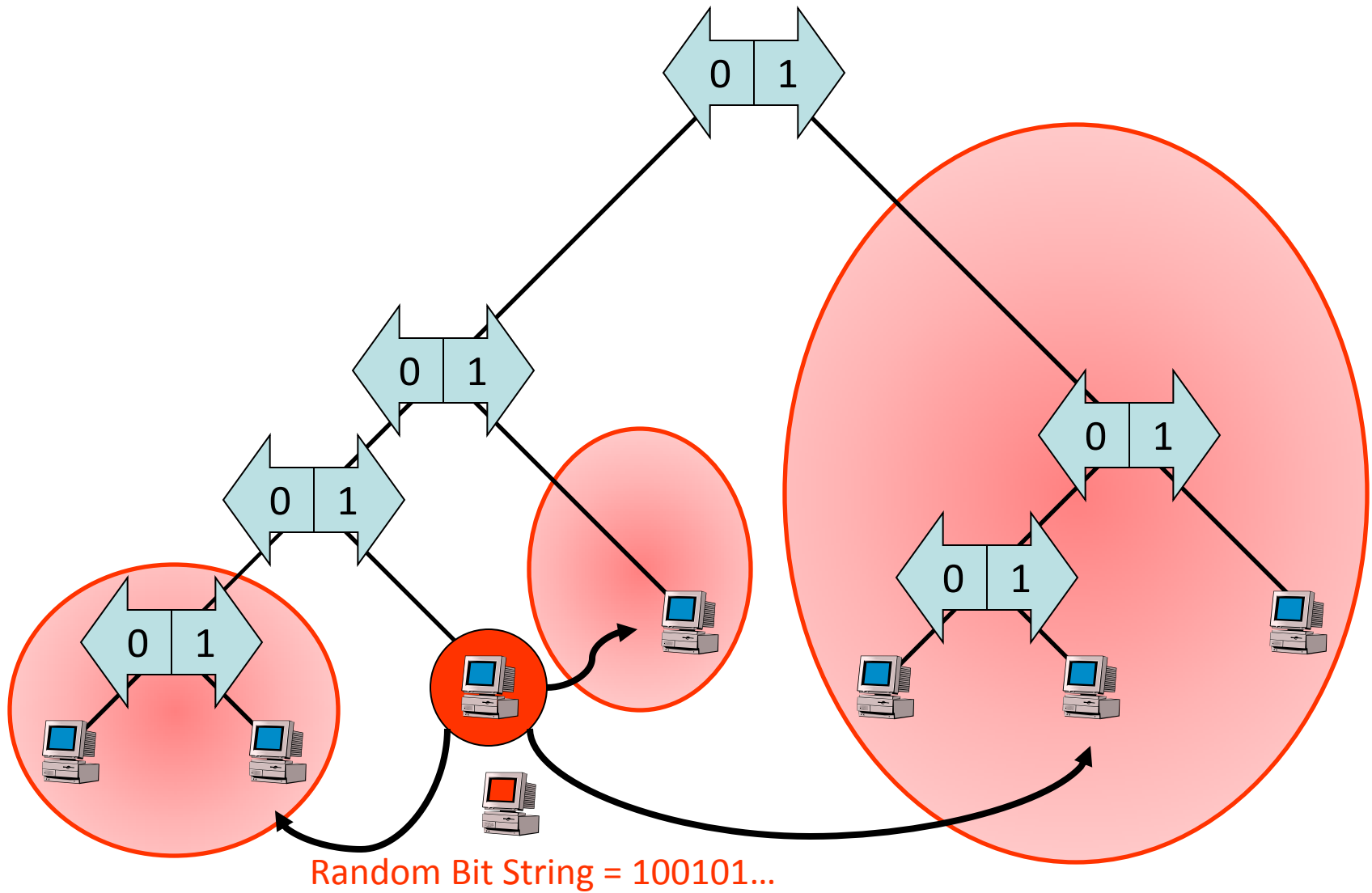

# New Peer Searches 100101...

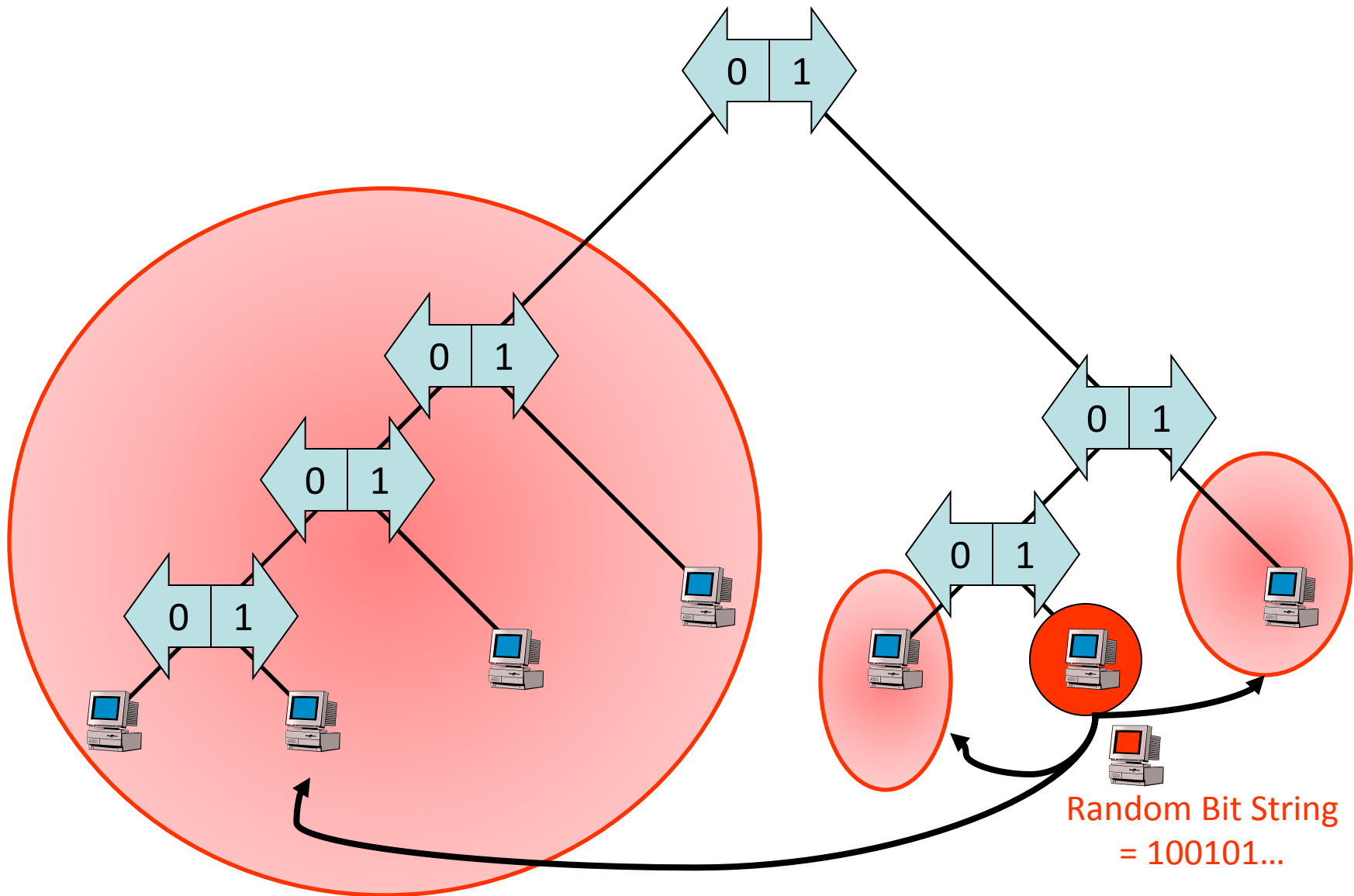

# New Peer found leaf with ID 100...

- The leaf and the new peer **split** the search space!

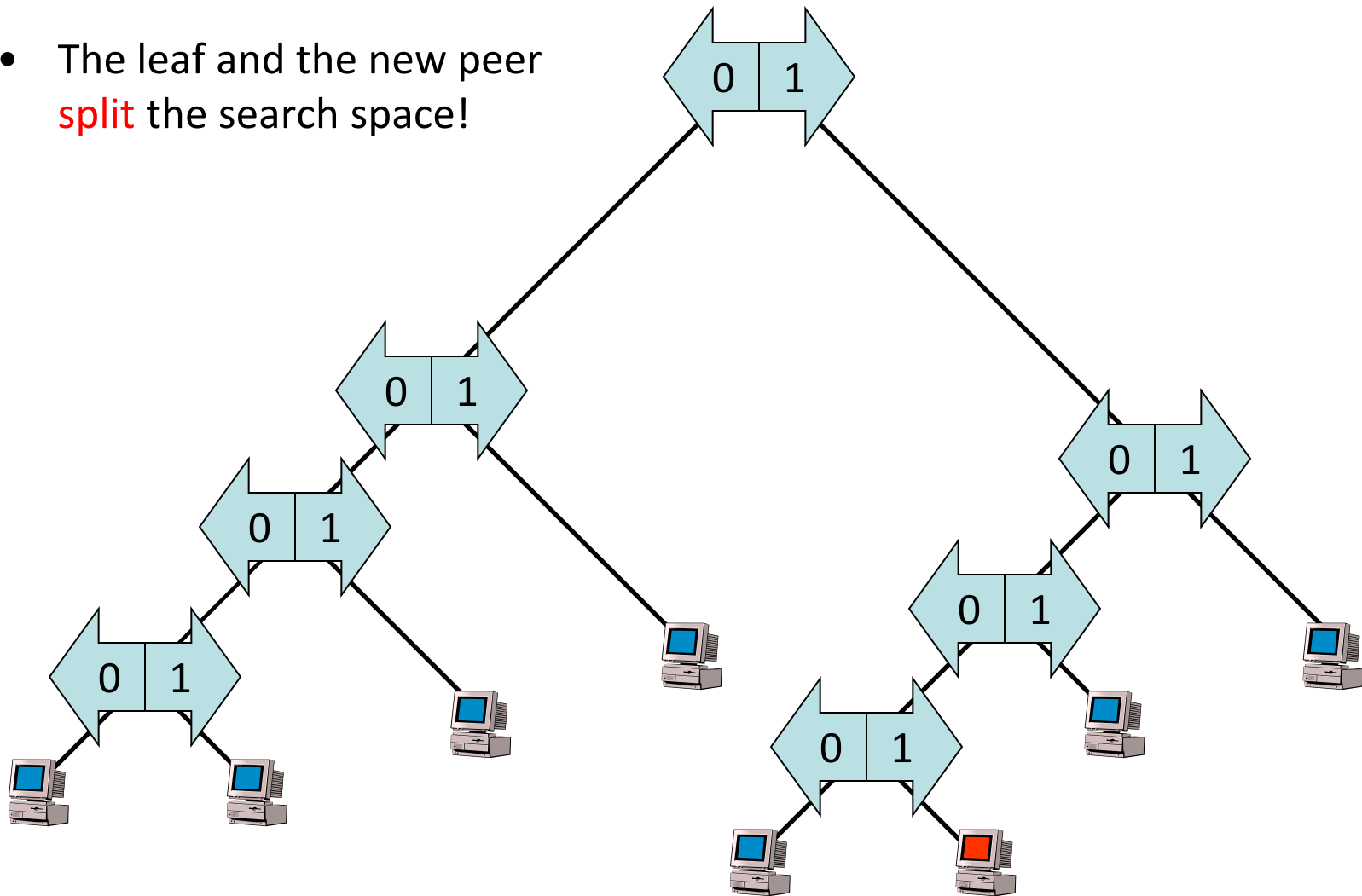

# Find Neighbors

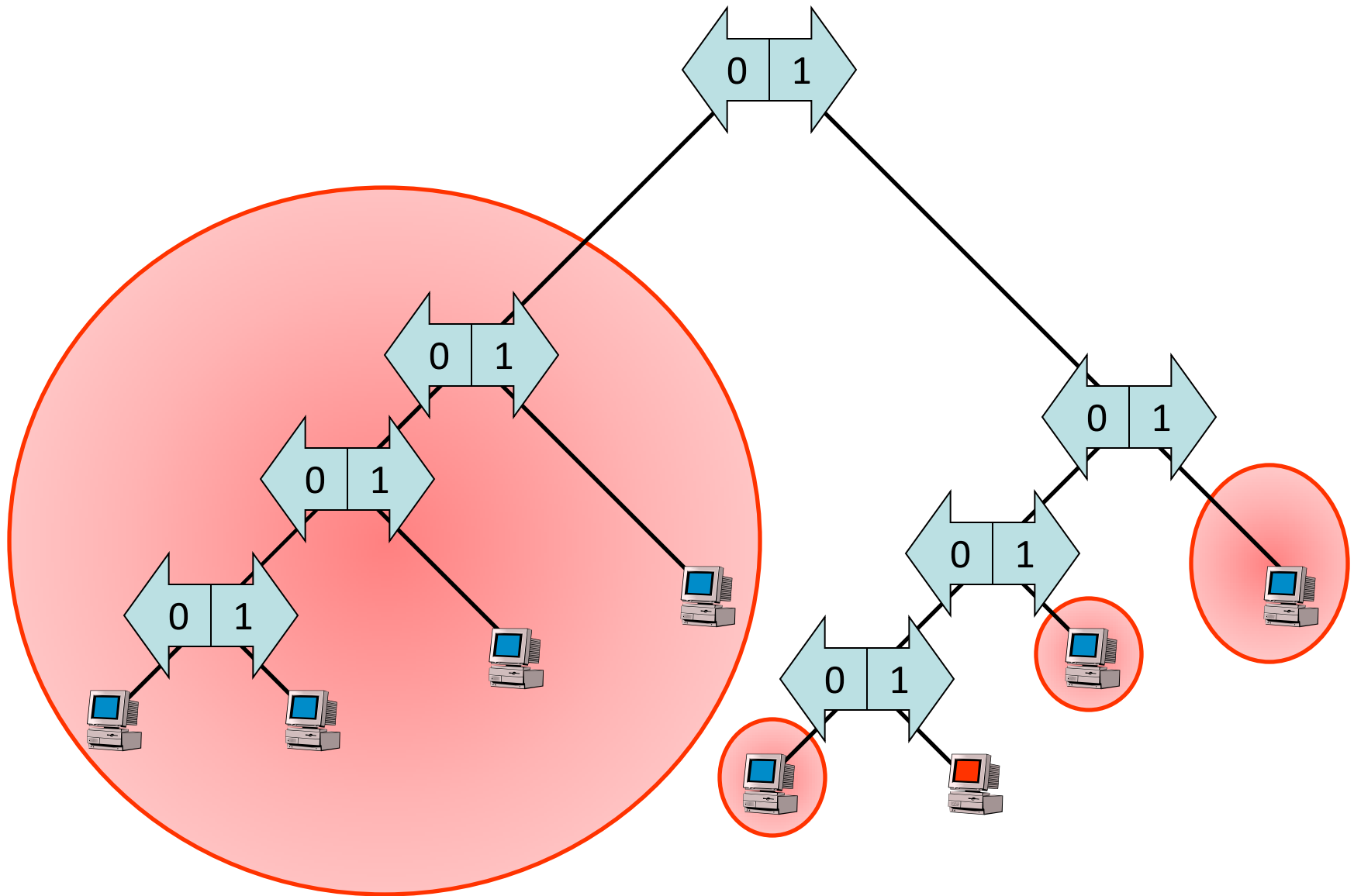

## Peer Join: Discussion

- If tree is balanced, the time to join is
  - $O(\log n)$  to find the right place
  - $O(\log n) \cdot O(\log n) = O(\log^2 n)$  to find all neighbors
- It is be widely believed that since all the peers choose their position randomly, the tree will remain more or less **balanced**
  - However, theory and simulations show that this is **not really true!**

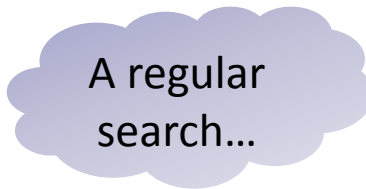

A regular search...



# Peer Leave

- Since a peer might leave **spontaneously** (there is no **leave message**), the leave must be detected first
- Naturally, this is done by the neighbors in the P2P system (all peers periodically ping neighbors)
- If a peer leave is detected, the peer must be replaced. If peer had a sibling leaf, the sibling might just do a “**reverse split**”:

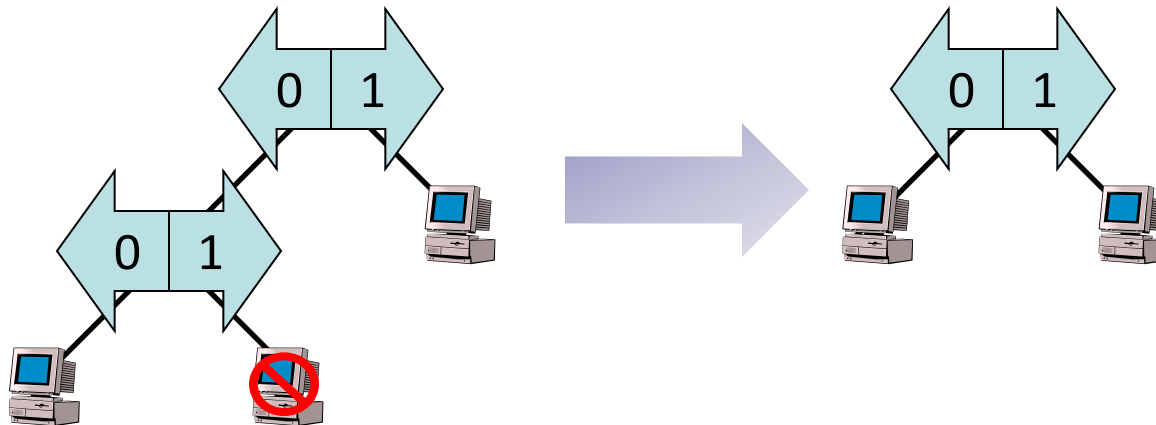

- If a peer does not have a sibling, search recursively!

# Peer Leave: Recursive Search

- Find a replacement:
  1. Go down the sibling tree until you find sibling leaves
  2. Make the left sibling the new common node
  3. Move the free right sibling to the empty spot

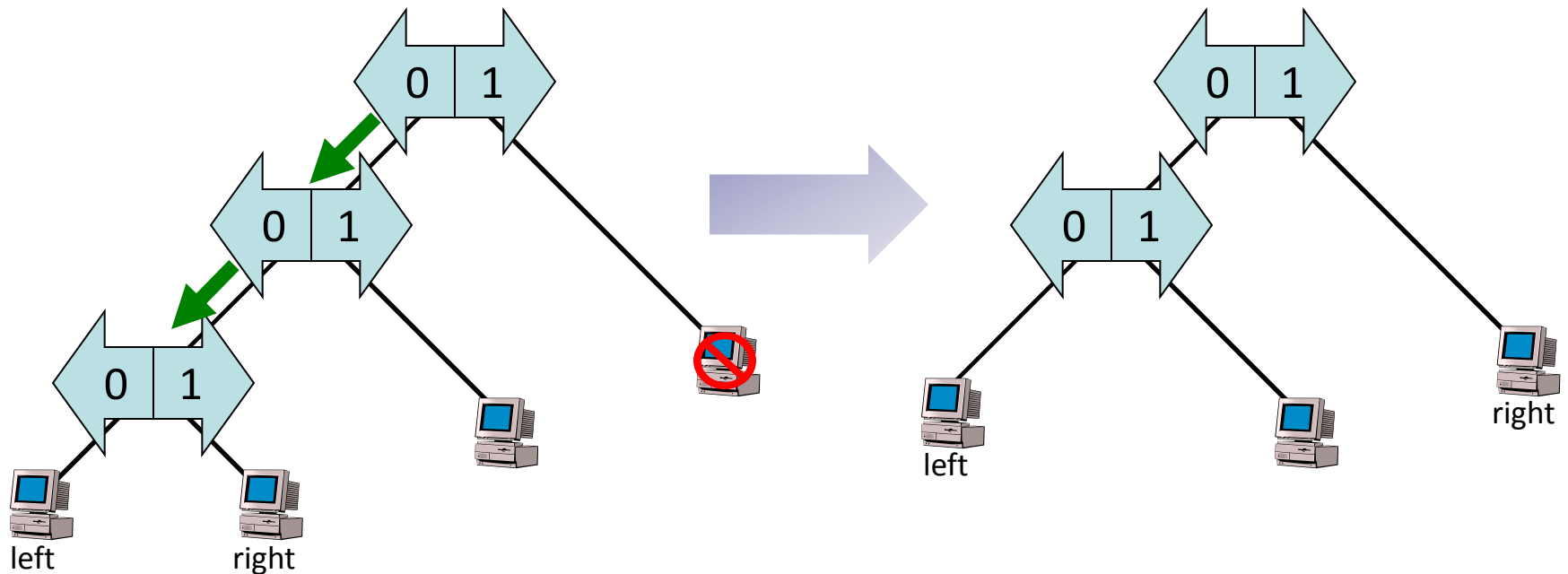

# Fault-Tolerance?

- In P2P file sharing, only pointers to the data is stored
  - If the data holder itself crashes, the data item is not available anymore
- What if the data holder is still in the system, but the peer that stores the pointer to the data holder crashes?
  - The data holder could advertise its data items periodically
  - If it cannot reach a certain peer anymore, it must search for the peer that is now responsible for the data item, i.e., the peer's ID is closest to the data item's key
- Alternative approach: Instead of letting the data holders take care of the availability of their data, let the system ensure that there is always a pointer to the data holder!
  - Replicate the information at several peers
  - Different hashes could be used for this purpose

## Questions of Experts...

- Question: I know so many other structured peer-to-peer systems (Chord, Pastry, Tapestry, CAN...); they are completely different from the one you just showed us!
- Answer: They *look* different, but in fact the difference comes mostly from the way they are presented (I give a few examples on the next slides)

# The Four P2P Evangelists

- If you read your average P2P paper, there are (almost) always four papers cited which “invented” efficient P2P in 2001:

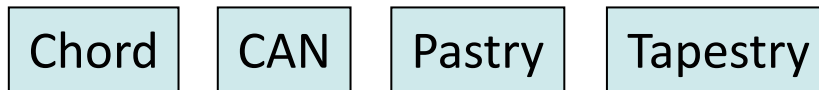

- These papers are somewhat similar, with the exception of CAN (which is not really efficient)
- So what are the „Dead Sea scrolls of P2P“?



## Intermezzo: “Dead Sea Scrolls of P2P”

„Accessing Nearby Copies of Replicated Objects in a Distributed Environment“ [Greg Plaxton, Rajmohan Rajaraman, and Andrea Richa, SPAA 1997]

- Basically, the paper proposes an efficient search routine (similar to the four famous P2P papers)
  - In particular **search**, **insert**, **delete**, **storage costs** are all **logarithmic**, the base of the logarithm is a parameter
- The paper takes latency into account
  - In particular it is assumed that nodes are in a **metric**, and that the graph is of „bounded growth“ (meaning that node densities do not change abruptly)

# Intermezzo: Genealogy of P2P

The parents of Plaxton et al.:  
Consistent Hashing, Compact Routing, ...

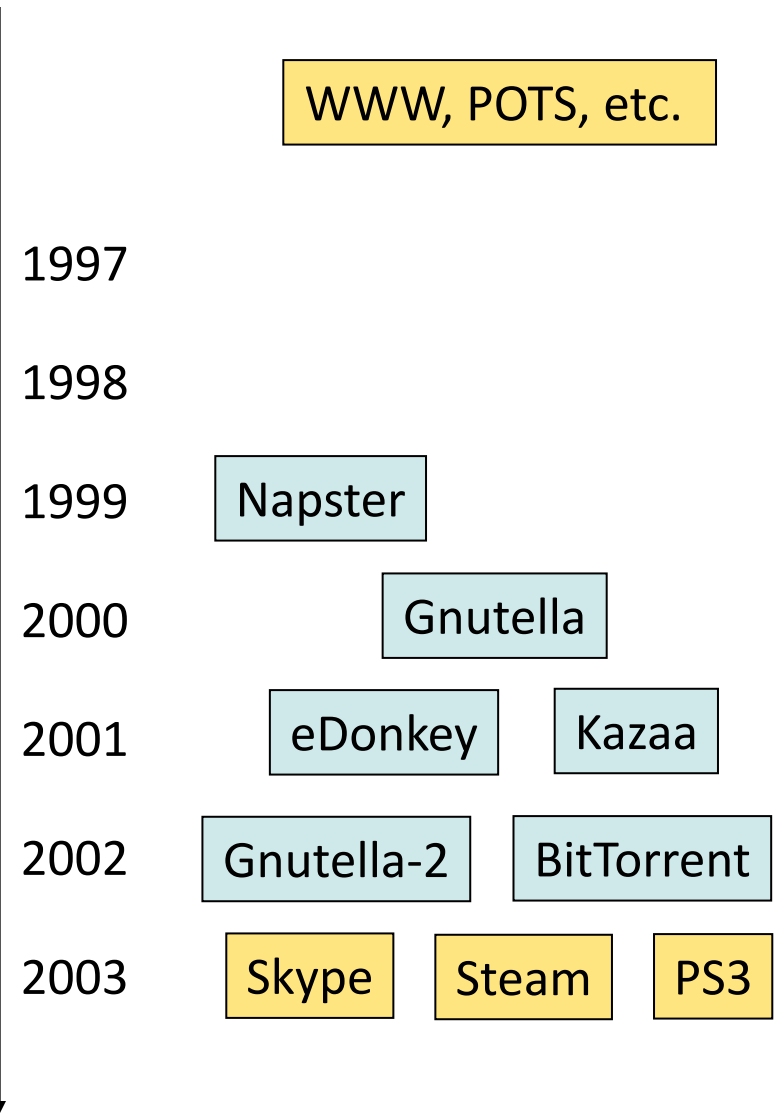
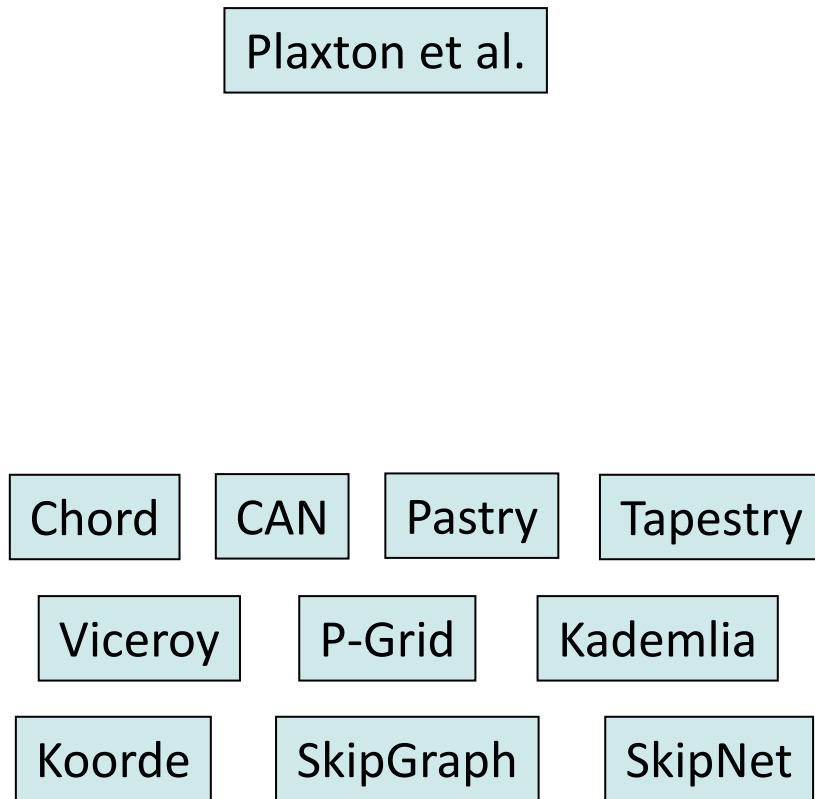

# Chord

- Chord is the most cited P2P system [Ion Stoica, Robert Morris, David Karger, M. Frans Kaashoek, and Hari Balakrishnan, SIGCOMM 2001]
- Most discussed system in distributed systems and networking books, for example in Edition 4 of Tanenbaum's Computer Networks
- There are extensions on top of it, such as CFS, Ivy...



# Chord

- Every peer has  $\log n$  many neighbors
  - One in distance  $\approx 2^{-k}$  for  $k=1, 2, \dots, \log n$

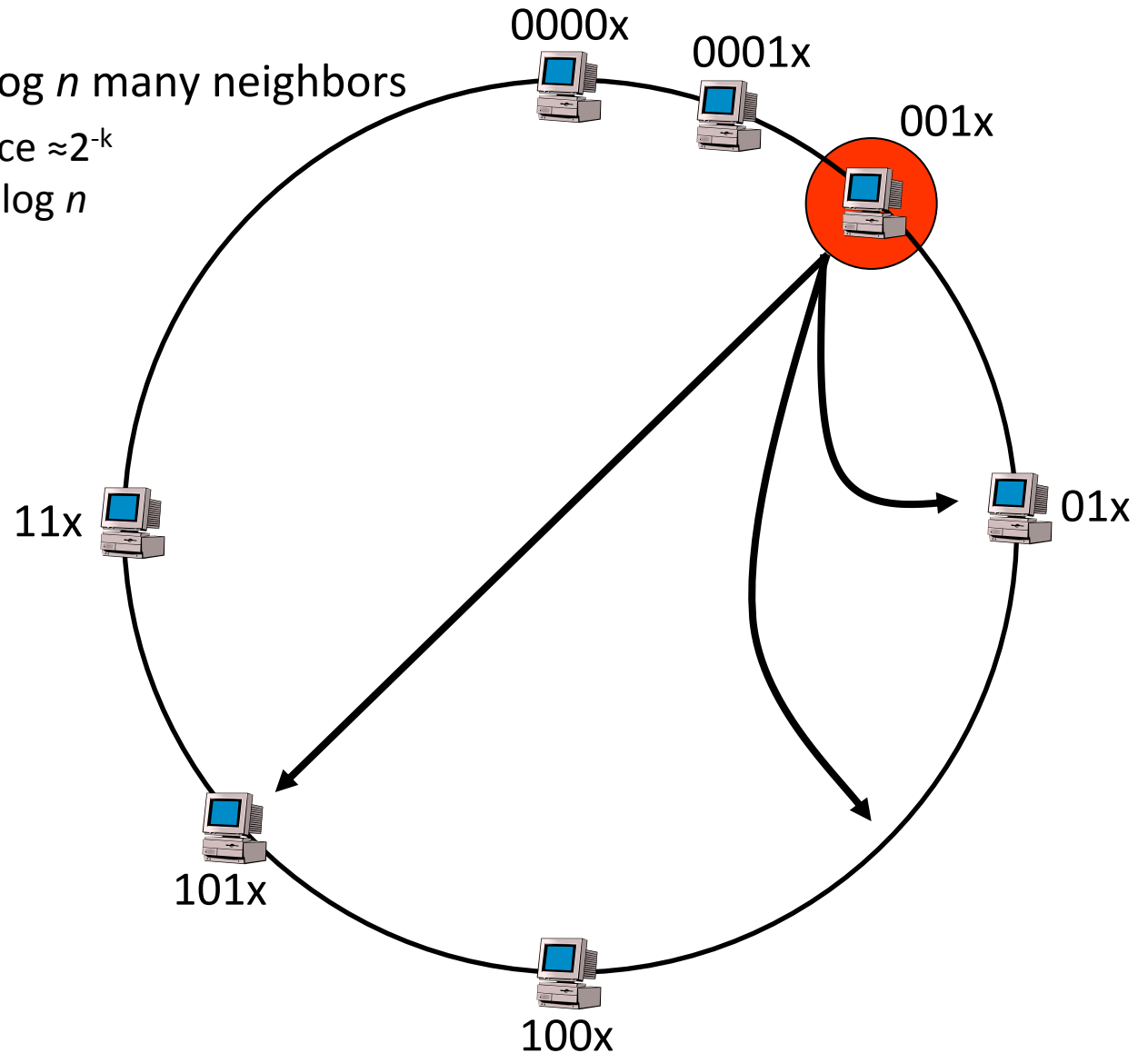

# Example: Dynamo

- Dynamo is a key-value storage system by Amazon (shopping carts)
- Goal: Provide an “always-on” experience
  - **Availability** is more important than **consistency**
- The system is (nothing but) a DHT
- Trusted environment (no Byzantine processes)
- Ring of nodes
  - Node  $n_i$  is responsible for keys between  $n_{i-1}$  and  $n_i$
  - Nodes join and leave dynamically
- Each entry **replicated** across  $N$  nodes
- Recovery from error:
  - When? On read
  - How? Depends on application, e.g. “last write wins” or “merge”
  - One vector clock per entry to manage different versions of data

Basically what we talked about

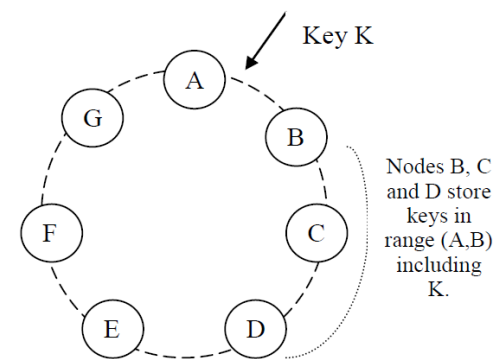
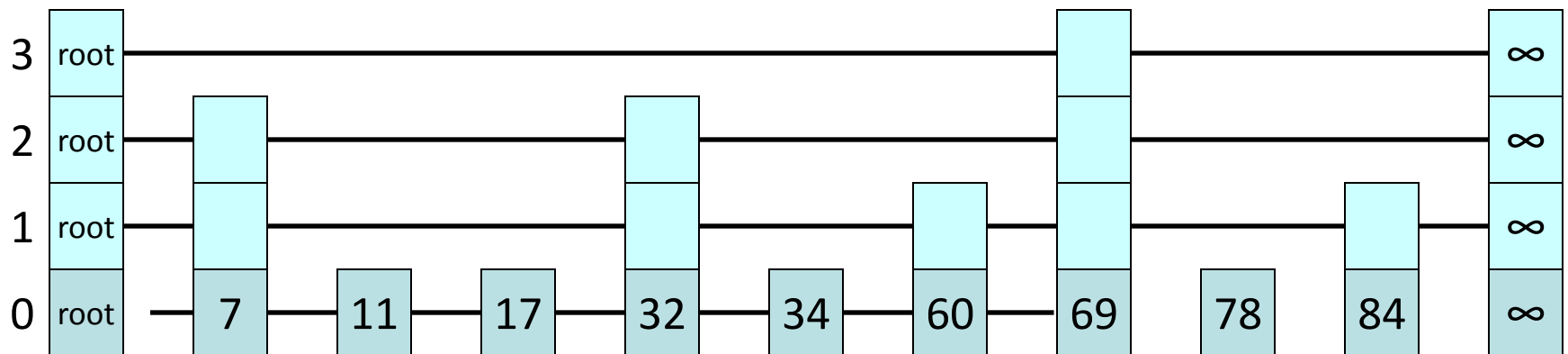

Figure 2: Partitioning and replication of keys in Dynamo ring.

# Skip List

- How can we ensure that the search tree is balanced?
  - We don't want to implement distributed AVL or red-black trees...
- Skip List:
  - (Doubly) linked list with sorted items
  - An item adds additional pointers on **level 1** with probability  $\frac{1}{2}$ . The items with additional pointers further add pointers on **level 2** with prob.  $\frac{1}{2}$  etc.
  - There are  $\log_2 n$  levels in expectation
- Search, insert, delete: Start with root, search for the right interval on highest level, then continue with lower levels



# Skip List

- It can easily be shown that search, insert, and delete terminate in  $O(\log n)$  expected time, if there are  $n$  items in the skip list
- The expected number of pointers is only **twice** as many as with a regular linked list, thus the **memory overhead** is **small**
- As a plus, the items are always ordered...

# P2P Architectures

- Use the skip list as a P2P architecture
  - Again each peer gets a random value between 0 and 1 and is responsible for storing that interval
  - Instead of a root and a sentinel node (“ $\infty$ ”), the list is short-wired as a **ring**
- Use the Butterfly or DeBruijn graph as a P2P architecture
  - Advantage: The node degree of these graphs is constant → Only a **constant number of neighbors** per peer
  - A search still only takes  **$O(\log n)$**  hops

# Dynamics Reloaded

- Churn: Permanent joins and leaves
  - Why permanent?
  - Saroiu et al.: „A Measurement Study of P2P File Sharing Systems“:  
Peers join system for one hour on average
  - **Hundreds of changes per second** with millions of peers in the system!
- How can we maintain desirable properties such as
  - connectivity
  - small network diameter
  - low peer degree?

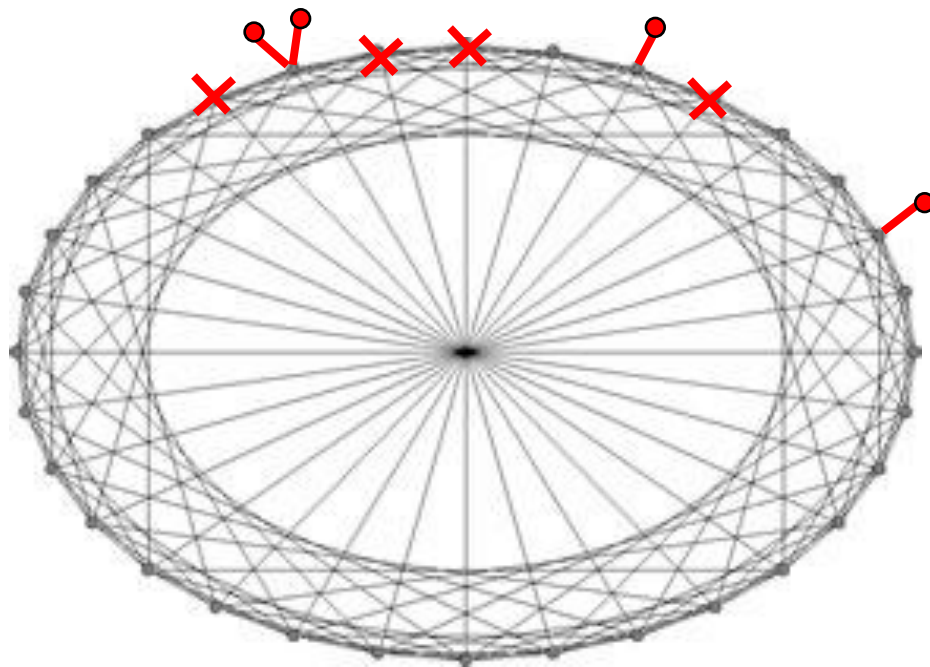

# A First Approach

- A fault-tolerant **hypercube**?
- What if the number of peers is not  $2^i$ ?
- How can we prevent **degeneration**?
- Where is the data stored?
- Idea: Simulate the **hypercube**!

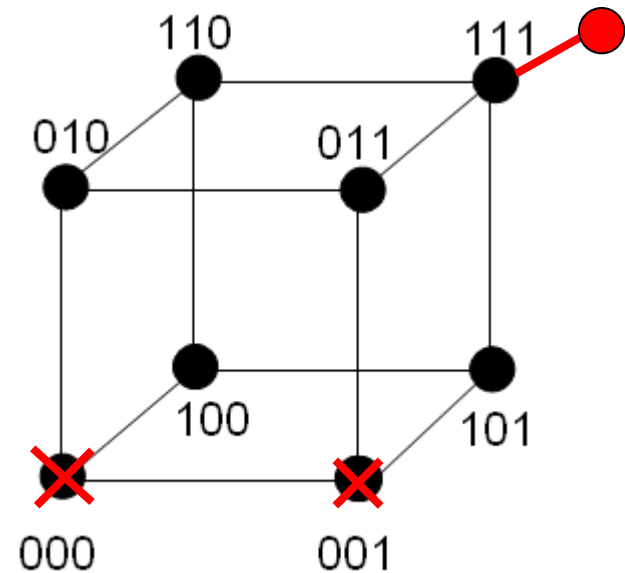

# Simulated Hypercube

- Simulation: Each node consists of several peers
- Basic components:
- Peer distribution
  - Distribute peers evenly among all hypercube nodes
  - A **token distribution problem**
- Information aggregation
  - Estimate the total number of peers
  - Adapt the dimension of the simulated hypercube

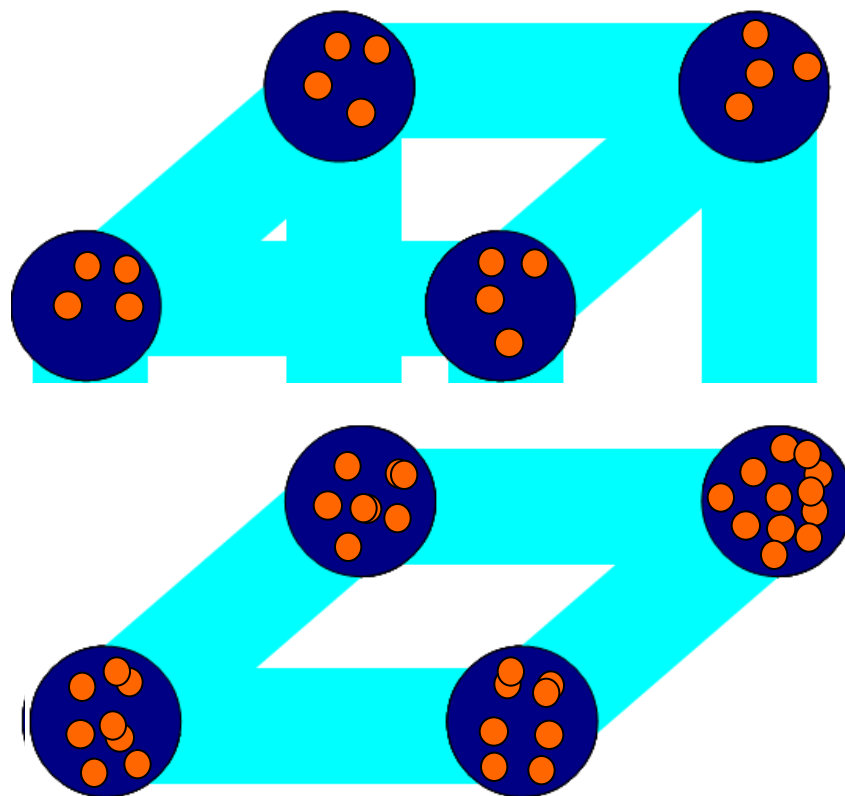



# Peer Distribution

- Algorithm: Cycle over dimensions and balance!
- Perfectly balanced after  $d$  rounds

Dimension of hypercube

- Problem 1: Peers are not **fractional**!
- Problem 2: Peers may join/leave during those  $d$  rounds!
- “Solution”: Round numbers and ignore changes during the  $d$  rounds

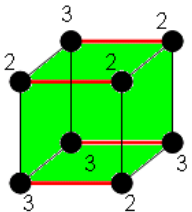
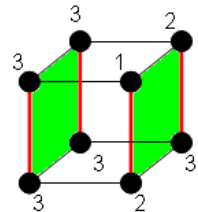
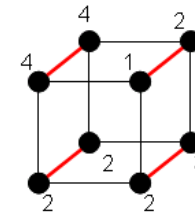
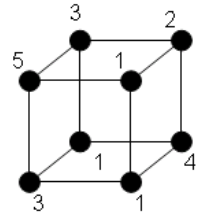
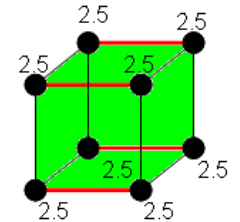
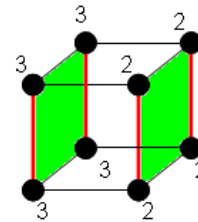
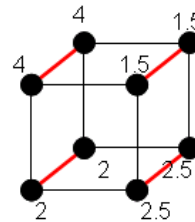
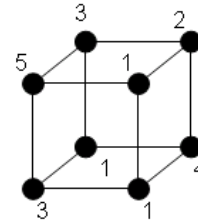

# Information Aggregation

- Goal: Provide the same (good!) estimation of the total number of peers presently in the system to all nodes
- Algorithm: Count peers in every sub-cube by exchanging messages with the corresponding neighbor!
- Correct number after  $d$  rounds

- Problem: Peers may join/leave during those  $d$  rounds!

- Solution: **Pipe-lined** execution

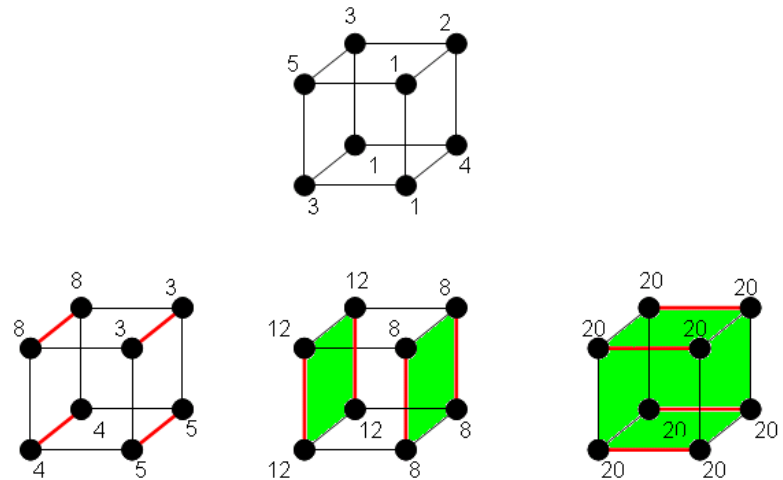

- It can be shown that all nodes get the same estimate
- Moreover, this number represents the correct state  $d$  rounds ago!

# Composing the Components

- The system permanently runs
  - the **peer distribution algorithm** to balance the nodes
  - the **information aggregation algorithm** to estimate the total number of peers and change the dimension accordingly
- How are the peers connected inside a simulated node, and how are the edges of the hypercube represented?
- Where is the data of the DHT stored?

# Distributed Hash Table

- Hash function determines node where data is **replicated**
- Problem: A peer that has to move to another node must replace store different data items
- Idea: Divide peers of a node into **core** and **periphery**
  - Core peers store data
  - Peripheral peers are used for peer distribution
- Peers inside a node are **completely connected**
- Peers are connected to all core peers of all neighboring nodes

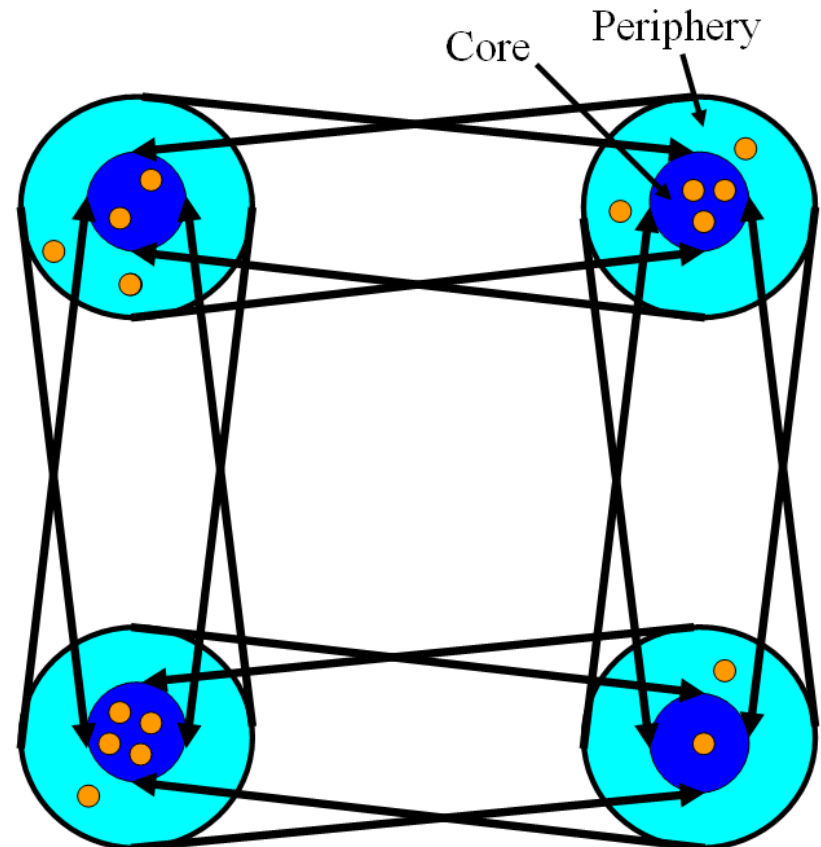

# Evaluation

- The system can tolerate  $O(\log n)$  joins and leaves each round
- The system is never fully repaired, but always fully functional!
- In particular, even if there are  $O(\log n)$  joins/leaves per round we always have
  - at least one peer per node
  - at most  $O(\log n)$  peers per node
  - a network diameter of  $O(\log n)$
  - a peer degree of  $O(\log n)$

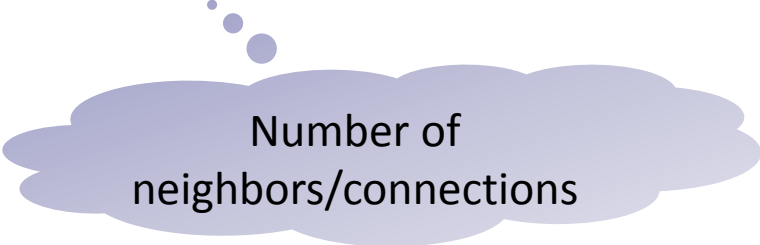

Number of  
neighbors/connections

# Byzantine Failures

- If Byzantine nodes control more and more corrupted nodes and then crash all of them at the same time (“sleepers”), we stand no chance.
- “Robust Distributed Name Service” [Baruch Awerbuch and Christian Scheideler, IPTPS 2004]
- Idea: Assume that the Byzantine peers are the minority. If the corrupted nodes are the majority in a specific part of the system, they can be **detected** (because of their unusual high density).

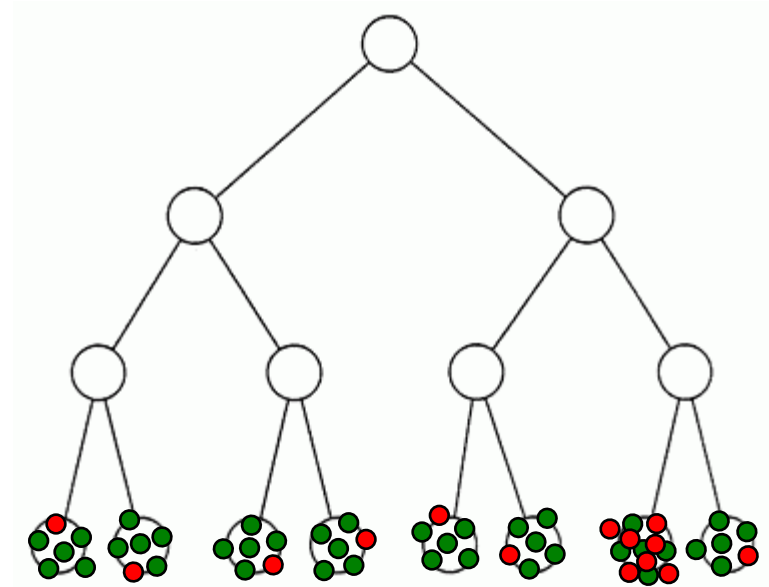

# Selfish Peers

- Peers may not try to destroy the system, instead they may try to benefit from the system without contributing anything
- Such **selfish behavior** is called **free riding** or **freeloading**
- Free riding is a common problem in file sharing applications:
- Studies show that most users in the Gnutella network do not provide anything
  - Gnutella is accessed through clients such as **BearShare**, **iMesh**...
- Protocols that are supposed to be “incentive-compatible”, such as **BitTorrent**, can also be exploited
  - The **BitThief** client downloads without uploading!



# Game Theory

- Game theory attempts to mathematically capture behavior in strategic situations (games), in which an individual's success in making choices depends on the choices of others.
- “Game theory is a sort of umbrella or 'unified field' theory for the rational side of social science, where 'social' is interpreted broadly, to include human as well as non-human players (computers, animals, plants)”  
[Aumann 1987]



game theory



# Selfish Caching

- P2P system where peer  $i$  experiences a demand  $w_i$  for a certain file.
  - Setting can be extended to multiple files
- A peer can either
  - cache the file for cost  $\alpha$ , or
  - get the file from the nearest peer  $l(i)$  that caches it for cost  $w_i \cdot d_{i,l(i)}$
- Example:  $\alpha = 4$ ,  $w_i = 1$

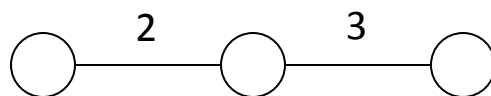

What is the global „best“ configuration?  
Who will cache the object?  
Which configurations are „stable“?

# Social Optimum & Nash Equilibrium

- In game theory, the „best“ configurations are called social optima
  - A social optimum maximizes the social welfare

## Definition

A strategy profile is called **social optimum** iff it minimizes the sum of all cost.

- A strategy profile is the set of strategies chosen by the players
- „Stable“ configurations are called (Nash) Equilibria

## Definition

A **Nash Equilibrium (NE)** is a strategy profile for which nobody can improve by unilaterally changing its strategy

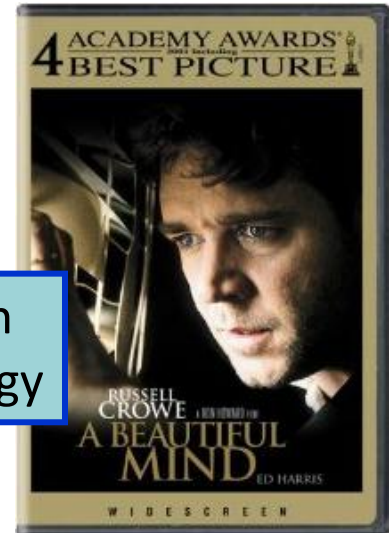

- Systems are assumed to magically converge towards a NE

## Selfish Caching: Example 2

- Which are the social optima, and the Nash Equilibria in the following example?
  - $\alpha = 4$

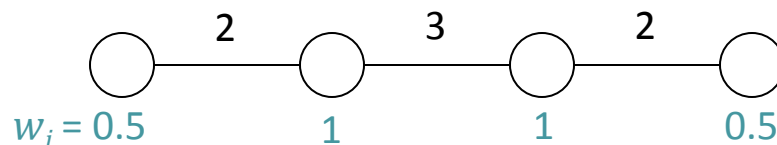

- Nash Equilibrium  $\not\leftrightarrow$  Social optimum
- Does every game have
  - a social optimum?
  - a Nash equilibrium?

# Selfish Caching: Equilibria

Theorem

Any instance of the selfish caching game has a Nash equilibrium

- **Proof by construction:**

- The following procedure always finds a Nash equilibrium

1. Put a peer  $y$  with highest demand into caching set
2. Remove all peers  $z$  for which  $d_{zy}w_z < \alpha$
3. Repeat steps 1 and 2 until no peers left

- The strategy profile where all peers in the caching set cache the file, and all others chose to access the file remotely, is a Nash equilibrium.

# Selfish Caching: Proof example

1. Put a peer  $y$  with highest demand into caching set
2. Remove all peers  $z$  for which  $d_{zy}w_z < \alpha$
3. Repeat steps 1 and 2 until no peers left

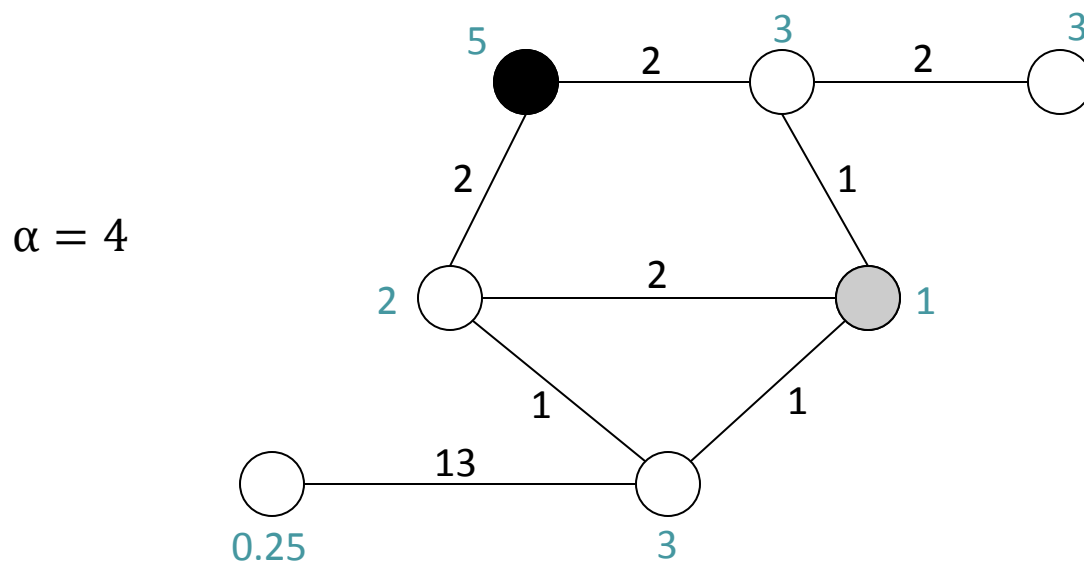

# Selfish Caching: Proof example

1. Put a peer  $y$  with highest demand into caching set
2. Remove all peers  $z$  for which  $d_{zy}w_z < \alpha$
3. Repeat steps 1 and 2 until no peers left

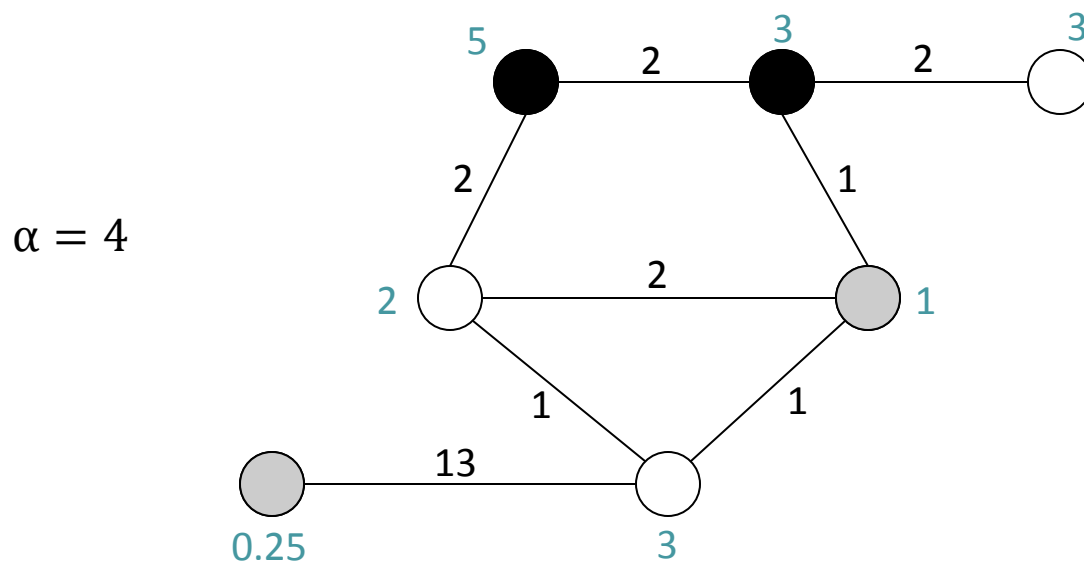

# Selfish Caching: Proof example

1. Put a peer  $y$  with highest demand into caching set
2. Remove all peers  $z$  for which  $d_{zy}w_z < \alpha$
3. Repeat steps 1 and 2 until no peers left

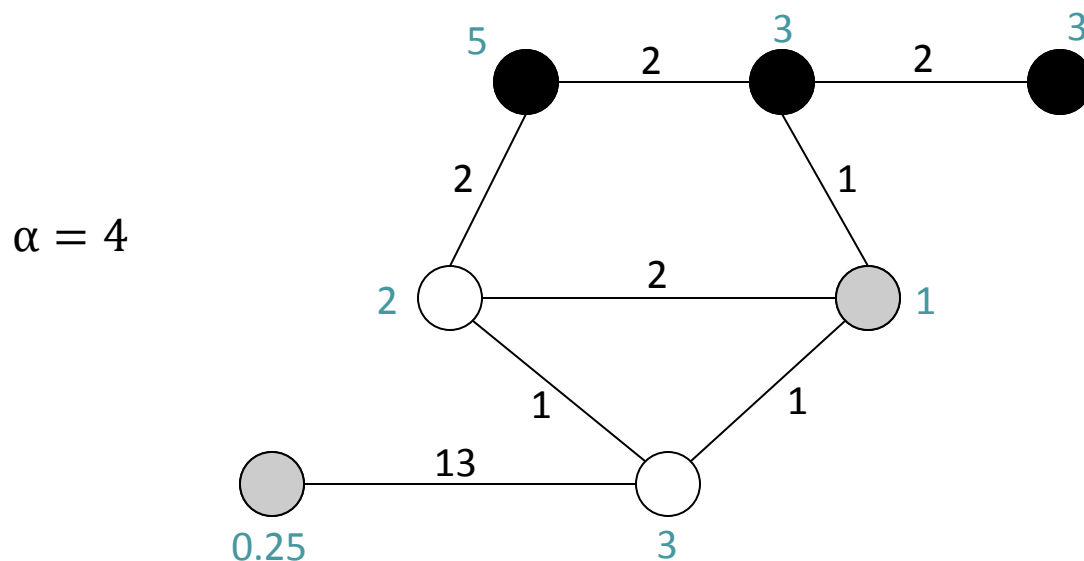

# Selfish Caching: Proof example

1. Put a peer  $y$  with highest demand into caching set
2. Remove all peers  $z$  for which  $d_{zy}w_z < \alpha$
3. Repeat steps 1 and 2 until no peers left

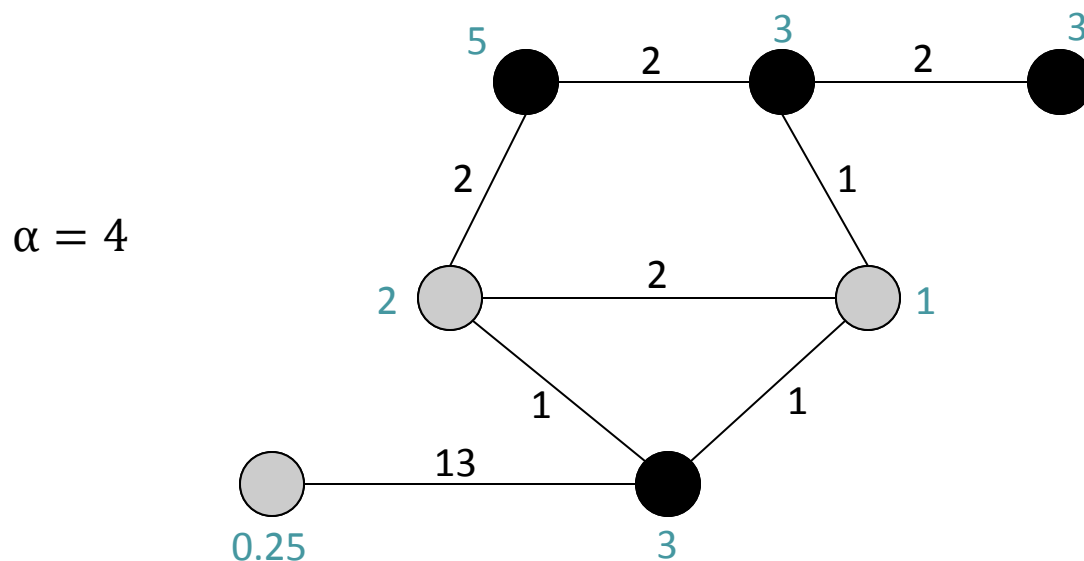

- Does NE condition hold for every peer?



# Proof

- If peer  $x$  not in the caching set
  - Exists  $y$  for which  $w_x d_{xy} < \alpha$
  - No incentive to cache because remote access cost  $w_x d_{xy}$  are smaller than placement cost  $\alpha$
- If peer  $x$  is in the caching set
  - For any other peer  $y$  in the caching set:
    - Case 1:  $y$  was added to the caching set before  $x$ 
      - It holds that  $w_x d_{xy} \geq \alpha$  due to the construction
    - Case 2:  $y$  was added to the caching set after  $x$ 
      - It holds that  $w_x \geq w_y$ , and  $w_y d_{yx} \geq \alpha$  due to the construction
      - Therefore  $w_x d_{xy} \geq w_y d_{yx} \geq \alpha$
  - $x$  has no incentive to stop caching because all other caching peers are too far away, i.e., the remote access cost are larger than  $\alpha$

# Price of Anarchy (PoA)

- With selfish peers any caching system converges to a stable equilibrium state
  - Unfortunately, NEs are often not optimal!

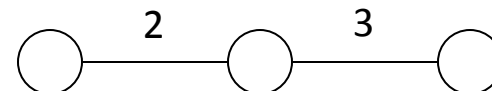

- Idea:
  - Quantify loss due to selfishness by comparing the performance of a system at Nash equilibrium to its optimal performance
    - Since a game can have more than one NE it makes sense to define a **worst-case Price of Anarchy (PoA)**, and an **optimistic Price of Anarchy (OPoA)**

Definition

$$PoA = \frac{\text{cost}(\text{worst NE})}{\text{cost}(\text{social Opt})}$$

Definition

$$OPoA = \frac{\text{cost}(\text{best NE})}{\text{cost}(\text{social Opt})}$$

- $PoA \geq OPoA \geq 1$
- A  $PoA$  close to 1 indicates that a system is unsusceptible to selfish behavior

# PoA for Selfish Caching

- How large is the (optimistic) price of anarchy in the following examples?

1)  $\alpha = 4$ ,  $w_i = 1$

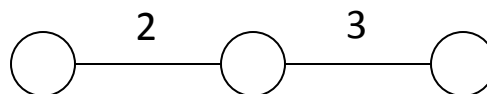

2)  $\alpha = 4$

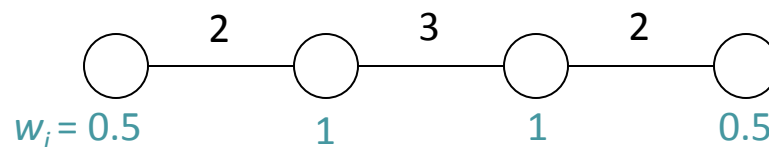

3)  $\alpha = 101$

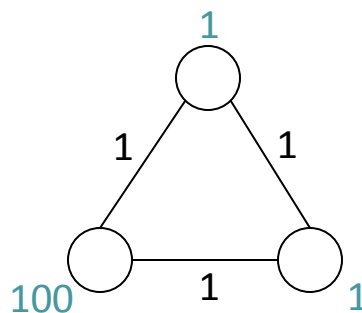

# PoA for Selfish Caching with constant demand and distances

- PoA depends on demands, distances, and the topology
- If all demands and distances are equal (e.g.  $w_i = 1$ ,  $d_{ij} = 1$ ) ...
  - How large can the PoA grow in cliques?

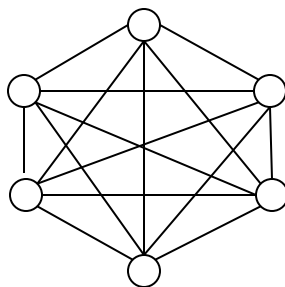

- How large can the PoA grow on a star?

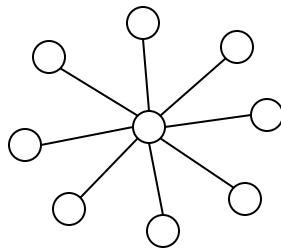

- How large can PoA grow in an arbitrary topology?

# PoA for Selfish Caching with constant demand

- PoA depends on demands, distances, and the topology
- Price of anarchy for selfish caching can be linear in the number of peers even when all peers have the same demand ( $w_i = 1$ )

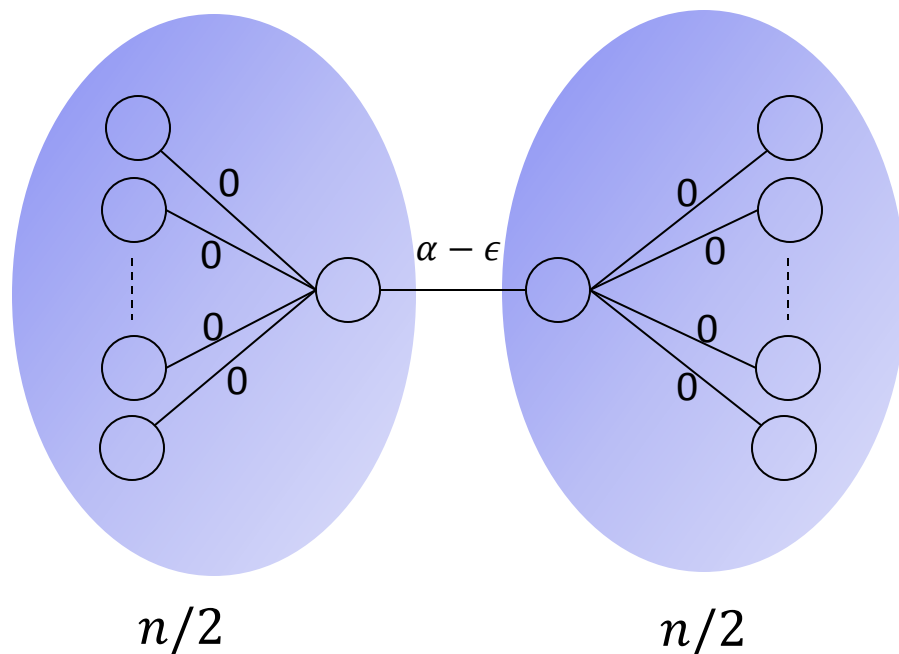

$$\text{cost}(NE) = \alpha + \frac{n}{2}(\alpha - \epsilon)$$

$$\text{cost}(OPT) = 2 \cdot \alpha$$

$$PoA = OPoA \stackrel{\epsilon \rightarrow 0}{=} \frac{1}{2} + \frac{n}{4} \in \Theta(n)$$

## Another Example: Braess' Paradox



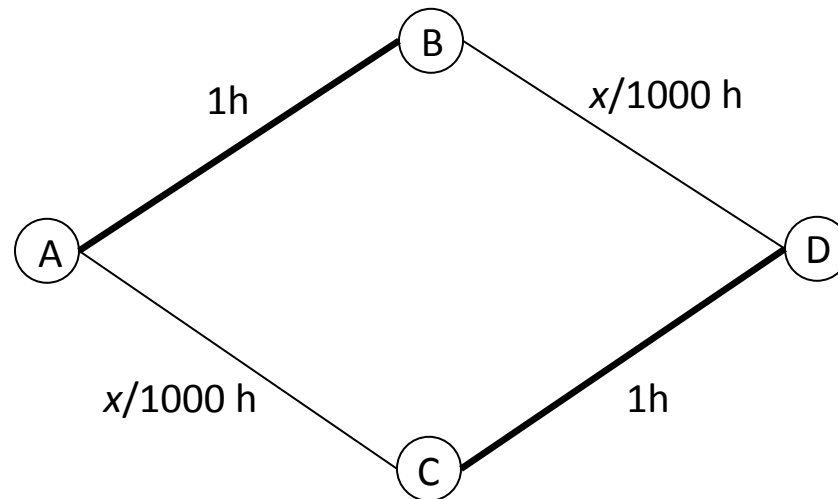



- Flow of 1000 cars per hour from A to D
- Drivers decide on route based on current traffic
- Social Optimum? Nash Equilibrium? PoA?

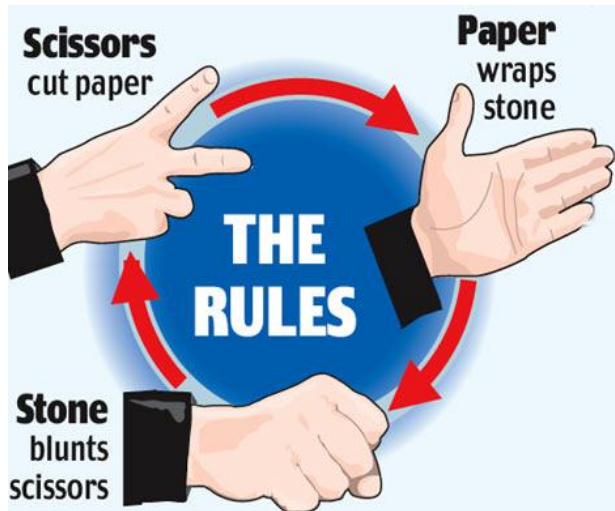



- Is there always a Nash equilibrium?

# Rock Paper Scissors



			
	0	-1	1
	1	0	-1
	-1	1	0

- Which is the best action:  ,  , or  ?
- What is the social optimum? What is the Nash Equilibrium?
- Any good strategies?

# Mixed Nash Equilibria

- Answer: Randomize !
  - Mix between pure strategies. A **mixed strategy** is a probability distribution over pure strategies.
  - Can you beat the following strategy in expectation?  
(  $p[\text{Rock}] = 1/2, p[\text{Paper}] = 1/4, p[\text{Scissors}] = 1/4$  )
  - The only (mixed) Nash Equilibrium is  $(1/3, 1/3, 1/3)$
  - Rock Paper Scissors is a so-called Zero-sum game

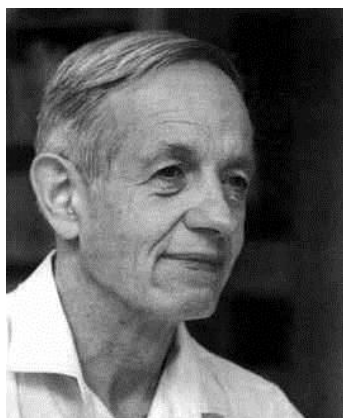

Theorem [Nash 1950]

Every game has a mixed Nash equilibrium



# Solution Concepts

- A solution concept predicts how a game turns out

## Definition

A **solution concept** is a rule that maps games to a set of possible outcomes, or to a probability distribution over the outcomes

- The **Nash equilibrium** as a solution concept predicts that any game ends up in a strategy profile where nobody can improve unilaterally.  
If a game has multiple NEs the game ends up in any of them.
- Other solution concepts:
  - **Dominant strategies**
    - A game ends up in any strategy profile where all players play a dominant strategy, given that the game has such a strategy profile
    - A strategy is dominant if, regardless of what any other players do, the strategy earns a player a larger payoff than any other strategy.
  - There are more, e.g. correlated equilibrium

# How can Game Theory help?

- Economy
  - understand markets?
  - Predict economy crashes?
  - Sveriges Riksbank Prize in Economics (“Nobel Prize”) has been awarded many times to game theorists
- Problems
  - GT models the real world inaccurately
  - Many real world problems are too complex to capture by a game
  - Human beings are not really rational
- GT in computer science
  - Players are not exactly human
  - Explain unexpected deficiencies (kazaa, emule, bittorrent etc.)
  - Additional measurement tool to evaluate distributed systems

# Mechanism Design

- **Game Theory** describes existing systems
  - Explains, or predicts behavior through solution concepts (e.g. Nash Equilibrium)
- **Mechanism Design** creates games in which it is best for an agent to behave as desired by the designer
  - incentive compatible systems
  - Most popular solution concept: dominant strategies
  - Sometimes Nash equilibrium
  - Natural design goals
    - Maximize social welfare
    - Maximize system performance

Mechanism design  $\approx$  „inverse“ game theory

# Incentives

- How can a mechanism designer change the incentive structure?
  - Offer rewards, or punishments for certain actions
    - Money, better QoS
    - Imprisonment, fines, worse QoS
  - Change the options available to the players
    - Example: fair cake sharing (MD for parents)
    - CS: Change protocol



# Selfish Caching with Payments

- Designer enables peers to reward each other with **payments**
- Peers offer **bids** to other peers for caching
  - Peers decide whether to cache or not after all bids are made
- $OPoA = 1$
- However,  $POA$  at least as bad as in the basic game

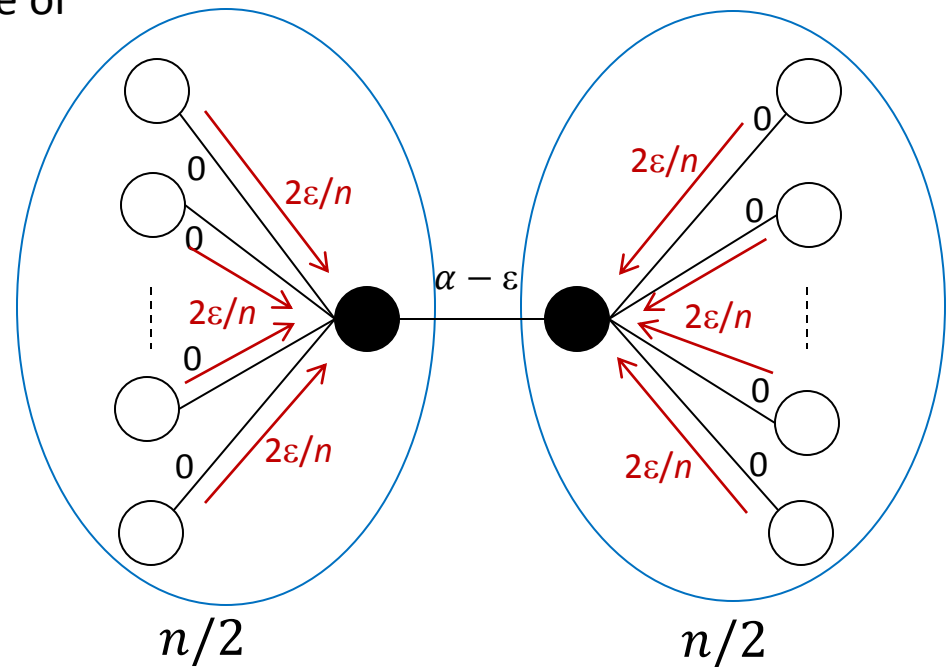
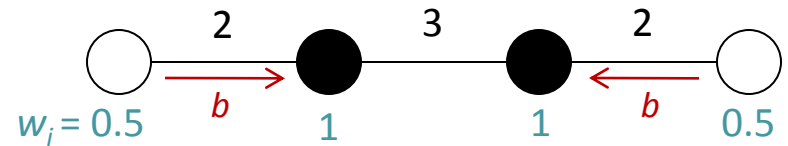

# Selfish Caching: Volunteer Dilemma

- Clique
  - Constant distances  $d_{ij} = 1$
  - Variable demands  $1 < w_i < \alpha = 20$
- Who goes first?
  - Peer with highest demand?
  - How does the situation change if the demands are not public knowledge, and peers can lie when announcing their demand?

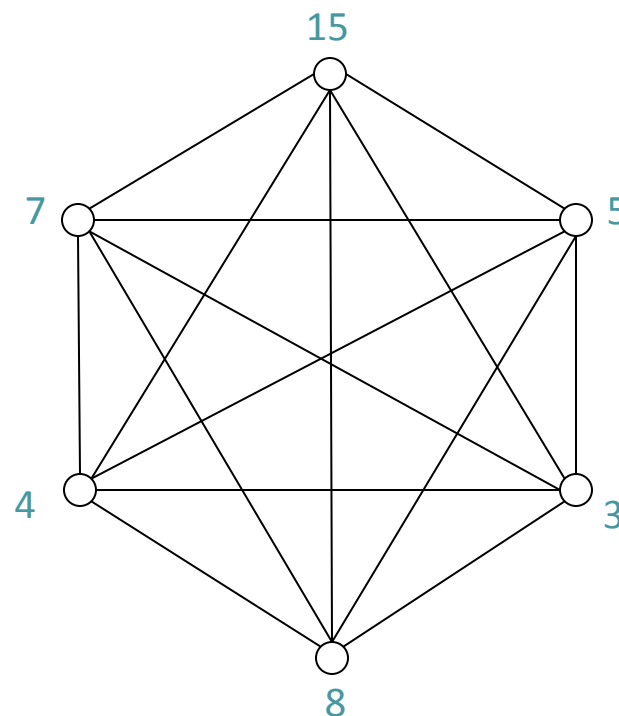

# Lowest-Price Auction

- Mechanism Designer
  - Wants to minimize social cost
  - Is willing to pay money for a good solution
  - Does not know demands  $w_i$

## Idea: Hold an auction

- Auction should generate competition among peers. Thus get a good deal.
  - Peers place private bids  $b_i$ . A bid  $b_i$  represents the minimal payment for which peer  $i$  is willing to cache.
  - Auctioneer accepts lowest offer.  
Pays  $b_{min} = \min_i b_i$  to the bidder of  $b_{min}$ .
- What should peer  $i$  bid?
    - $\alpha - w_i \leq b_i$
    - $i$  does not know other peers' bids

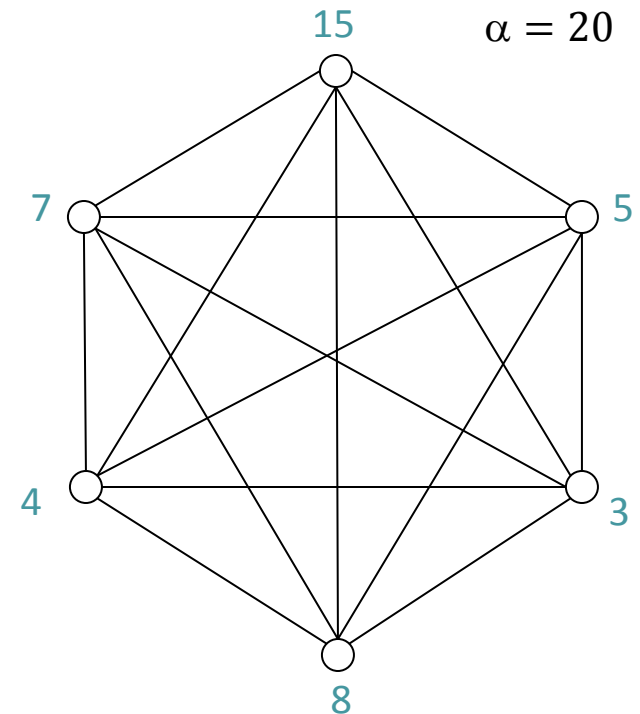

# Second-Lowest-Price Auction

- The auctioneer chooses the peer with the lowest offer, but pays the price of the second lowest bid!
- What should  $i$  bid?
  - Truthful ( $b_i = \alpha - w_i$ ), overbid, or underbid?

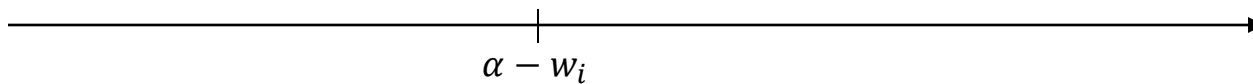
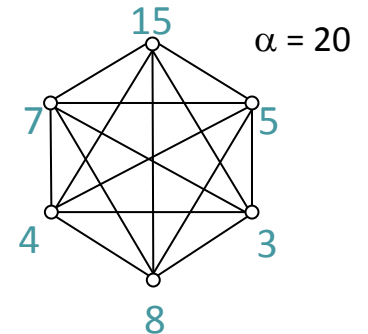

Theorem

Truthful bidding is the dominant strategy in a second-price auction



# Proof

- Let  $v_i = \alpha - w_i$ . Let  $b_{min} = \min_{j \neq i} b_j$ .
- The payoff for  $i$  is  $b_{min} - v_i$  if  $b_i < b_{min}$ , and 0 otherwise.
- „truthful dominates underbidding“
  - If  $b_{min} > v_i$  then both strategies win, and yield the same payoff.
  - If  $b_{min} < b_i$  then both strategies lose.
  - If  $b_i < b_{min} < v_i$  then underbidding wins the auction, but the payoff is negative. Truthful bidding loses, and yields a payoff of 0.
  - Truthful bidding is never worse, but in some cases better than underbidding.
- „truthful dominates overbidding“
  - If  $b_{min} > b_i$  then both strategies win and yield the same payoff
  - If  $b_{min} < v_i$  then both strategies lose.
  - If  $v_i < b_{min} < b_i$  then truthful bidding wins, and yields a positive payoff. Overbidding loses, and yields a payoff of 0.
  - Truthful bidding is never worse, but in some cases better than overbidding.
- Hence truthful bidding is the dominant strategy for all peers  $i$ .

## Another Approach: 0-implementation

- A third party can implement a strategy profile by offering high enough „insurances“
  - A mechanism implements a strategy profile  $S$  if it makes all strategies in  $S$  dominant.
- Mechanism Designer publicly offers the following deal to all peers except to the one with highest demand,  $p_{max}$ :
  - „If nobody choses to cache I will pay you a gazillion.“
- Assuming that a gazillion compensates for not being able to access the file, how does the game turn out?

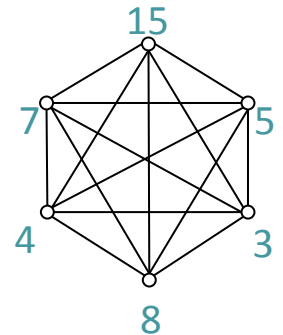

Theorem

Any Nash equilibrium can be implemented for free

# MD for P2P file sharing

- Gnutella, Napster etc. allow easy free-riding
- BitTorrent suggests that peers offer better QoS (upload speed) to collaborative peers
  - However, it can also be exploited
  - The BitThief client downloads without uploading!
    - Always claims to have nothing to trade yet
    - Connects to much more peers than usual clients



- Many techniques have been proposed to limit free riding behavior
  - Tit-for-tat (T4T) trading
    - Allowed fast set (seed capital),
    - Source coding,
    - indirect trading,
    - virtual currency...
  - Reputation systems
    - shared history



increase trading opportunities

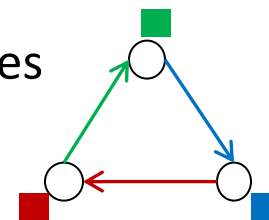

# MD in Distributed Systems: Problems

- Virtual currency
  - no trusted mediator
  - Distributed mediator hard to implement
- Reputation systems
  - collusion
  - Sibyl attack

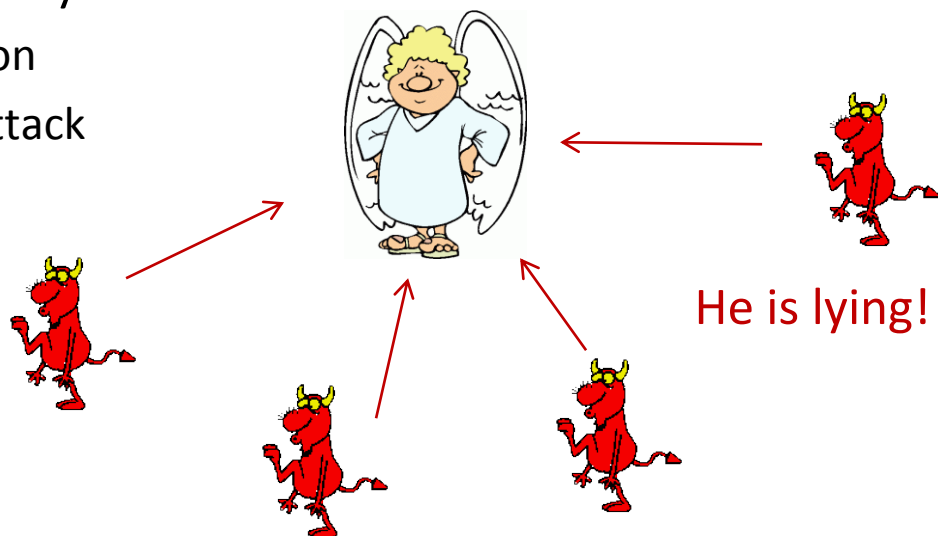

- Malicious players
  - Peers are not only selfish but sometimes Byzantine

# Summary

- We have systems that guarantee strong consistency
  - 2PC, 3PC
  - Paxos
  - Chubby
  - PBFT, Zyzyva, PeerReview, FARSITE
- We also talked about techniques to handle large-scale networks
  - Consistent hashing
  - DHTs, P2P techniques
  - Dynamics
  - Dynamo
- In addition, we have discussed several other issues
  - Consistency models
  - Selfishness, game theory

# Credits

- The Paxos algorithm is due to Lamport, 1998.
- The Chubby system is from Burrows, 2006.
- PBFT is from Castro and Liskov, 1999.
- Zyzyvva is from Kotla, Alvisi, Dahlin, Clement, and Wong, 2007.
- PeerReview is from Haeberlen, Kouznetsov, and Druschel, 2007.
- FARSITE is from Adya et al., 2002.
- Concurrent hashing and random trees have been proposed by Karger, Lehman, Leighton, Levine, Lewin, and Panigrahy, 1997.
- The churn-resistant P2P System is due to Kuhn et al., 2005.
- Dynamo is from DeCandia et al., 2007.
- Selfish Caching is from Chun et al., 2004.
- Price of Anarchy is due to Koutsoupias and Papadimitriou, 1999.
- Second-price auction is by Vickrey, 1961.
- K-implementation is by Monderer and Tennenholtz, 2003.