

Discrete Event Systems

Introduction

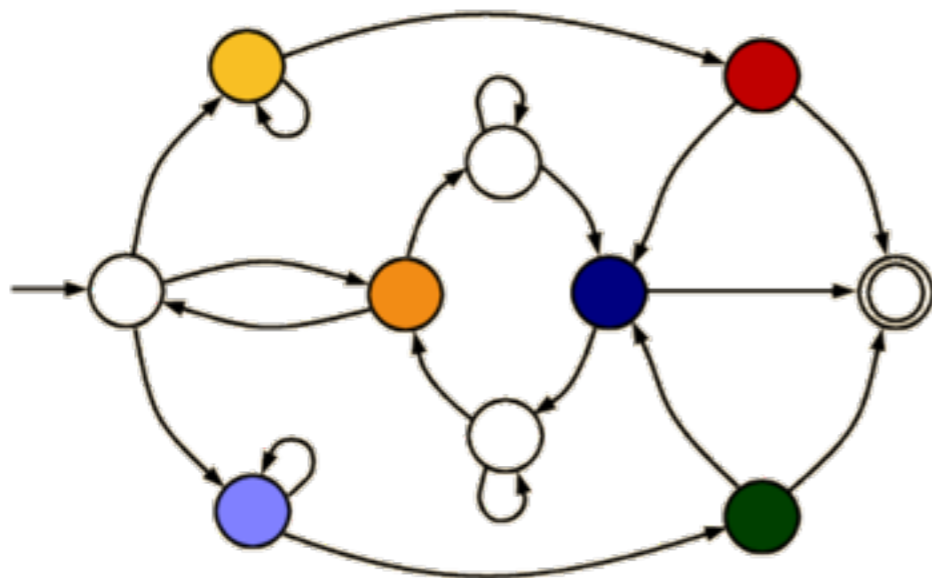

Laurent Vanbever

www.vanbever.eu

ETH Zürich (D-ITET)

September, 17 2015

Discrete Event Systems

Discrete Event Systems

Why should you care?

Being based on natural phenomena,
Science is often explained by continuous variables



Mechanics

$$F = G \frac{m_1 m_2}{r^2}$$

Gravitation

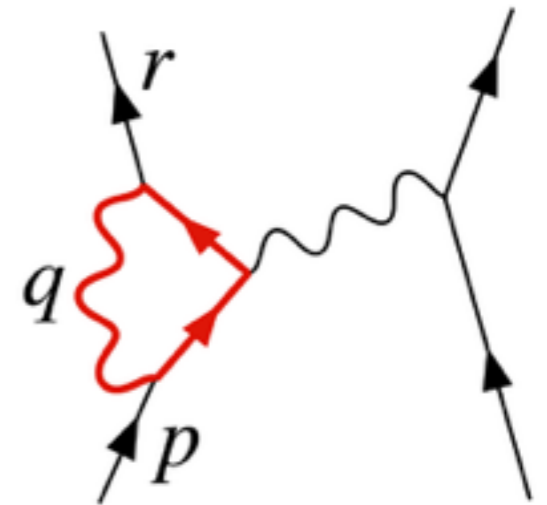

Electrodynamic

Being based on natural phenomena,
Science is often explained by continuous variables



Mechanics

$$F = G \frac{m_1 m_2}{r^2}$$

Gravitation

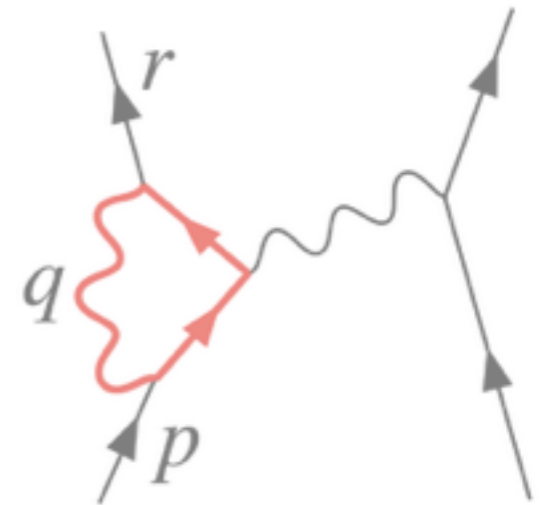

Electrodynamic

solved by differential equations

Many complex systems are not continuous...



computer
systems

Somewhere inside Google datacenters



transportation
systems

NYC subway system

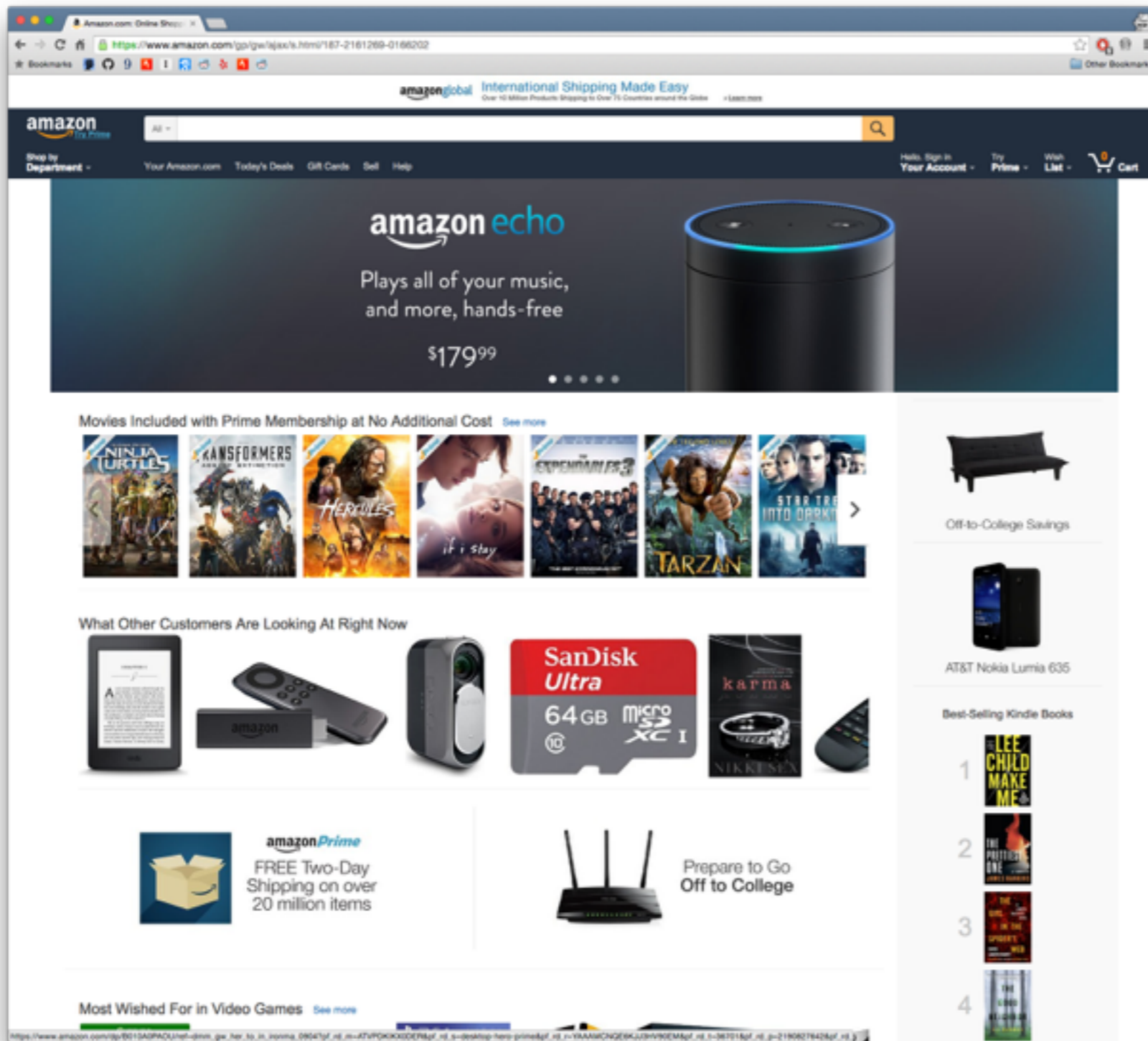

software
systems

amazon.com home page

Those systems are determined by
discrete events

Customers requests

Telephone calls

Train arrivals

Incoming data

Equipment failures

...

In this course, you'll learn how to

Model

Analyze

Design

Discrete Event Systems

Test

Optimize

some examples

Model

automata & petri nets

Analyze

average-, worst-case viewpoint

Design

out of a specification

Test

proof system properties

Optimize

minimize the system size

There will be 3 professors in the course

Part I



Laurent Vanbever

Automatas

Part II



Roger Wattenhofer

Stochastic process

Part III



Lothar Thiele

Specification model

Week 1-5



Laurent Vanbever

Automatas

Week 6-10



Roger Wattenhofer

Stochastic process

Week 11-13



Lothar Thiele

Specification model

Course organization

Lectures

Thursday 1 pm-3pm

@ETZ 9

Exercices

Thursday 3pm-5pm

@ETZ 9

Materials

<http://www.disco.ethz.ch/lectures/des/>

Automata & languages

A primer on the Theory of Computation

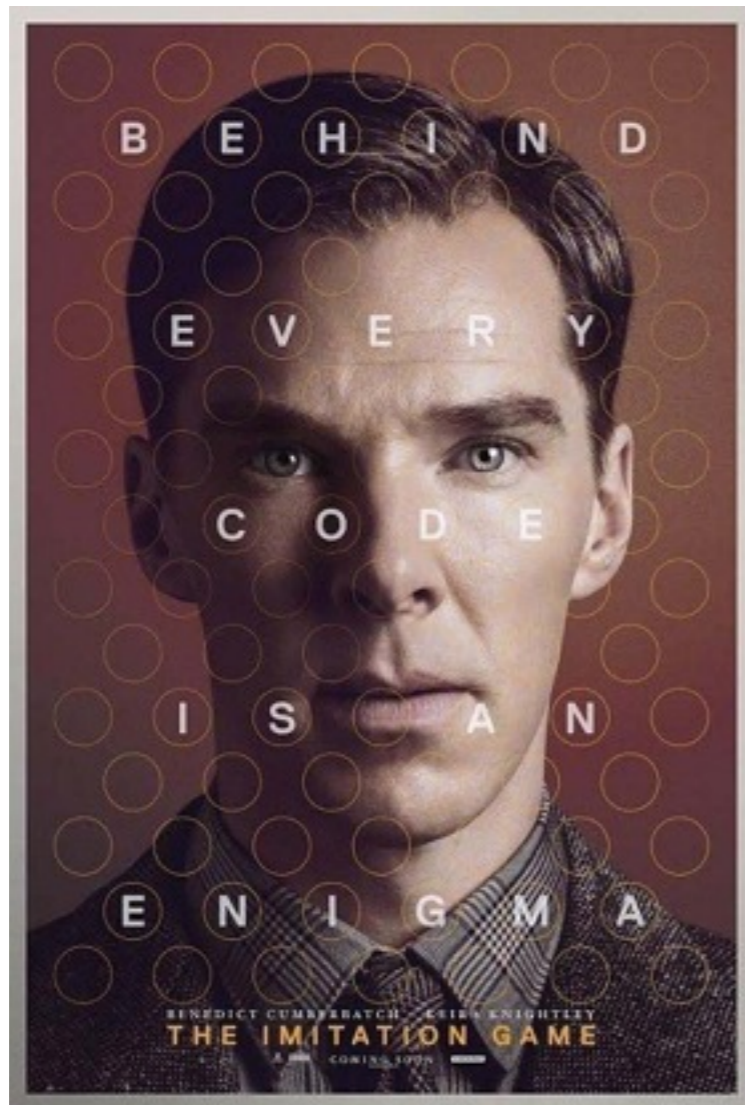

Laurent Vanbever

www.vanbever.eu

ETH Zürich (D-ITET)

September, 17 2015

The imitation game (2014)

Benedict Cumberbatch

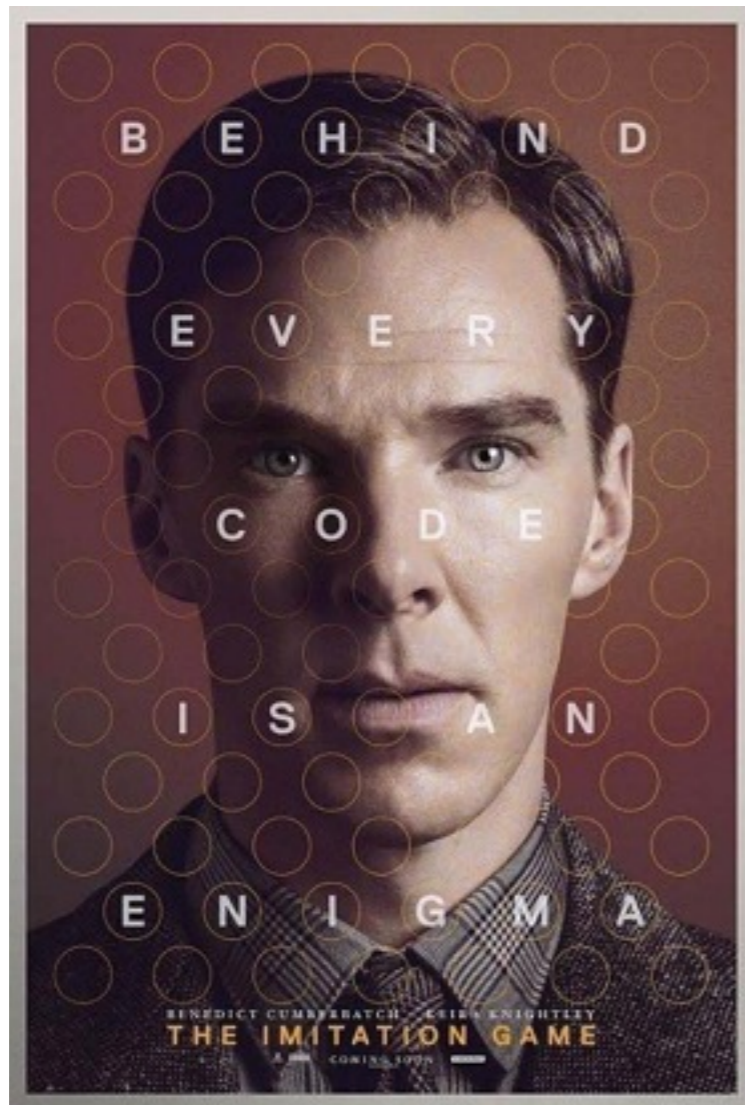

Alan Turing (1912-1954)

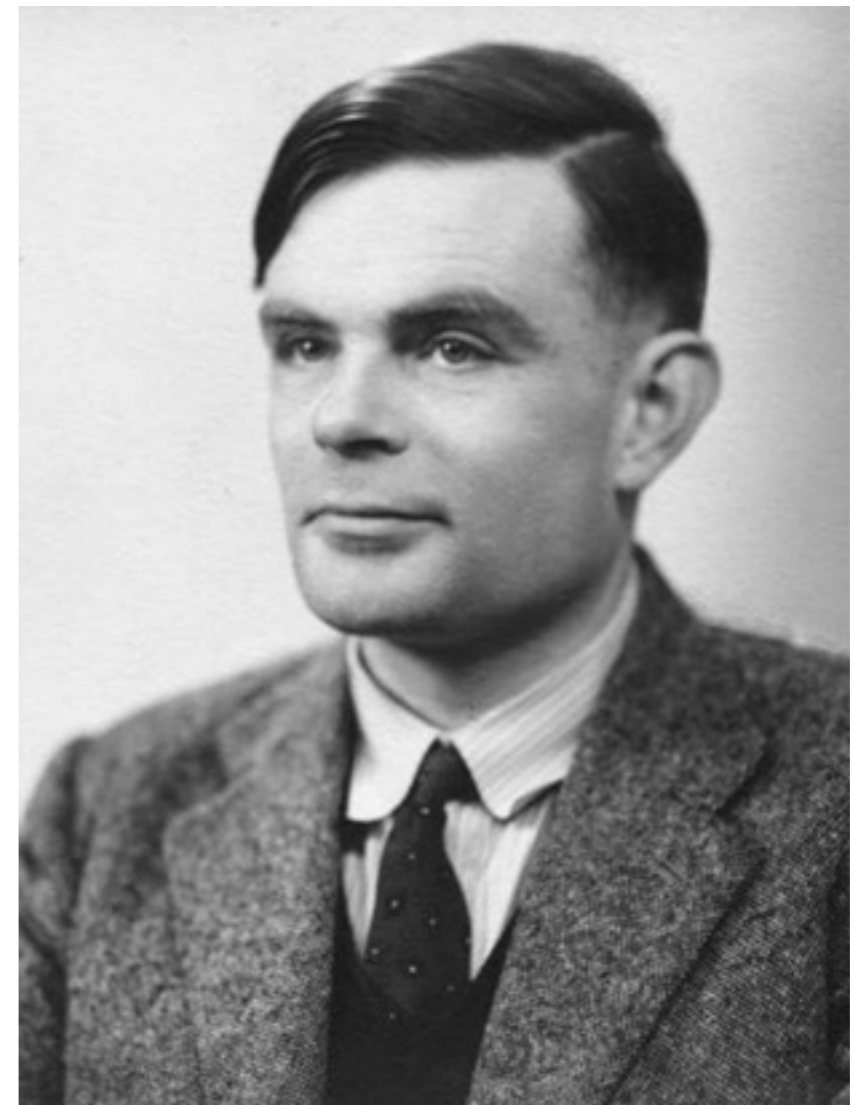

Brief CV

created computer science
as we know it

invented a universal computer
model, the Turing machine

broke German cyphers,
most notably Enigma

invented the Turing Test
to distinguish human from machine

Alan Turing (1912-1954)

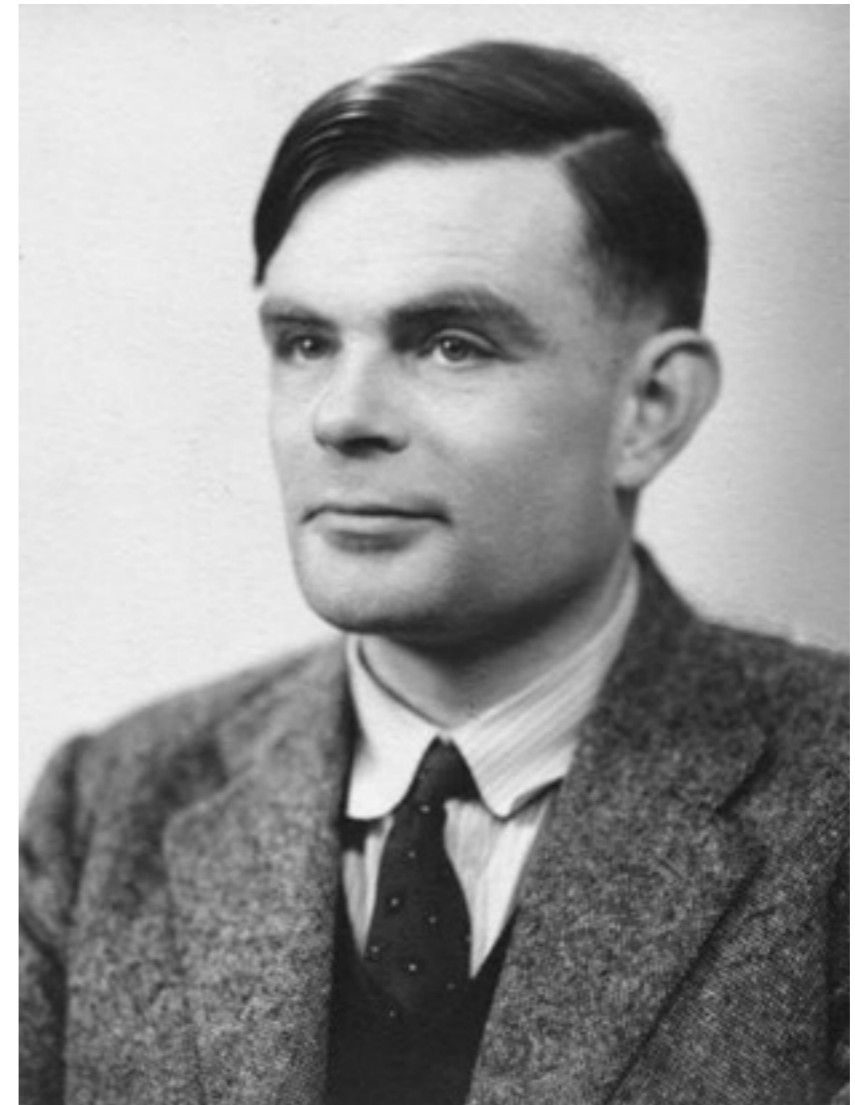

invented a universal computer
model, the Turing machine



studied the fundamental
limitations of computers

Can a computer compute anything?

Halting problem

Alan Turing, 1936

Given an arbitrary
program P & an input I

Decide whether P will

- halt, eventually
- loop, forever

when run on I

This problem **cannot be solved**
by a computer (no matter its power)

Many other problems were shown
to be “uncomputable”

https://en.wikipedia.org/wiki/List_of_undecidable_problems

Post-correspondance
problem

Emil Post, 1946

Given a set of dominos:

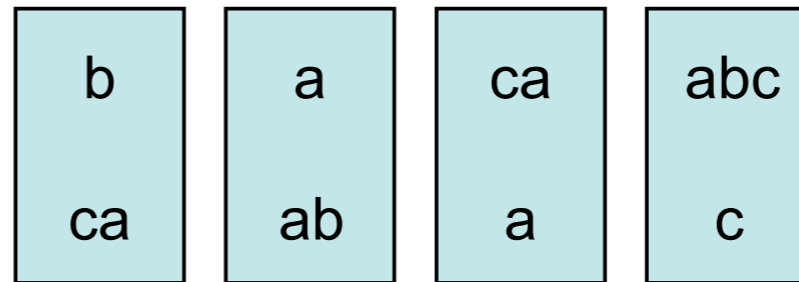

Make a list of them *s.t.*
the top string equals
the bottom one, *e.g.*

(repetitions
are allowed)

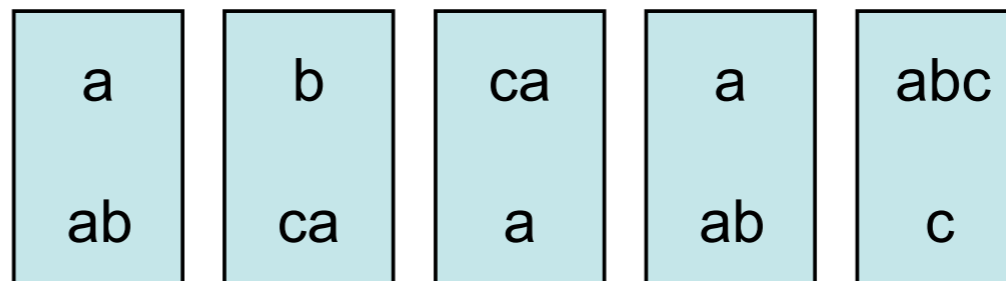

In this part of the course,
we'll learn about what is “computable” and “not”

We'll study three models of computation,
from the least powerful to the most

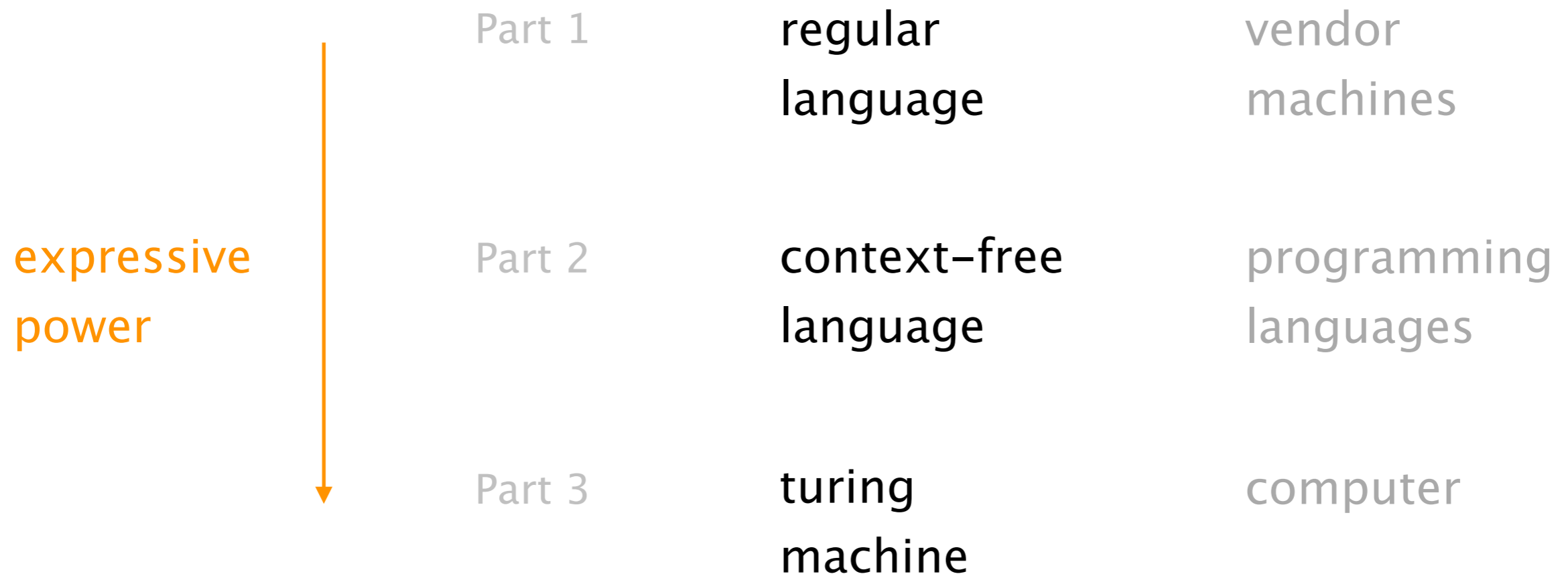

Automata & languages

A primer on the Theory of Computation

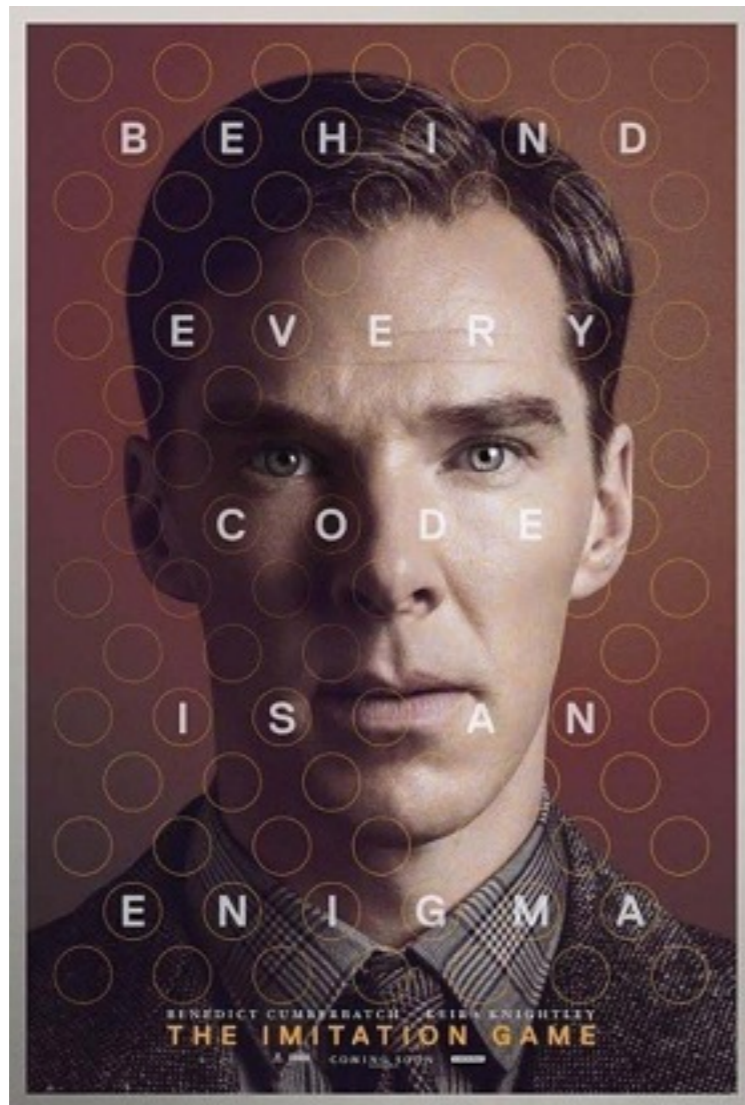

Part 1

regular
language

Part 2

context-free
language

Part 3

turing
machine

Automata & languages

A primer on the Theory of Computation

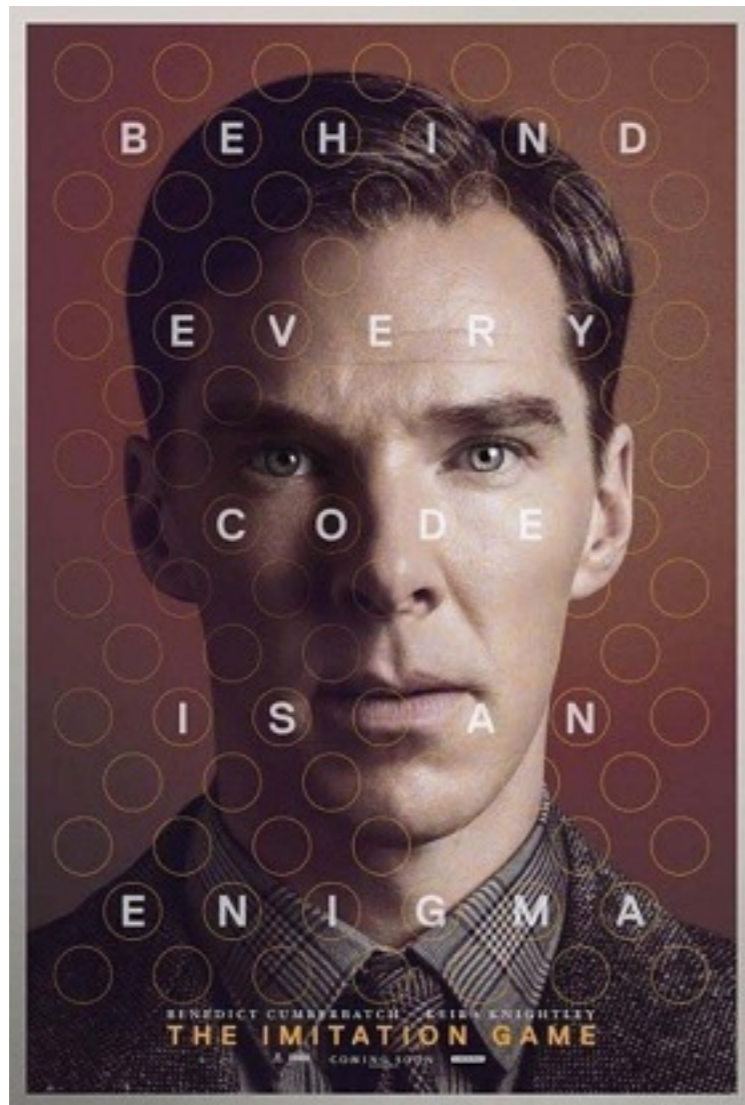

Part 1

regular
language

context-free
language

turing
machine

Part I: Regular Languages

Finite Automata

Thu Sept 17

1

Examples

2

Definition

3

Design

4

Regular operations

- closure

- union *et al.*

The Coke Vending Machine

- Vending machine dispenses soda for \$0.45 a pop.
- Accepts only dimes (\$0.10) and quarters (\$0.25).
- Eats your money if you don't have correct change.
- You're told to "implement" this functionality.



Vending Machine Java Code

```
Soda vend() {  
    int total = 0, coin;  
    while (total != 45) {  
        receive(coin);  
        if ((coin==10 && total==40)  
            || (coin==25 && total>=25))  
            reject(coin);  
        else  
            total += coin;  
    }  
    return new Soda();  
}
```



Why this was overkill...

- Vending machines have been around long before computers.
 - Or Java, for that matter.
- Don't really need int's.
 - Each int introduces 2^{32} possibilities.
- Don't need to know how to add integers to model vending machine
 - `total += coin.`
- Java grammar, if-then-else, etc. complicate the essence.

Vending Machine "Logics"

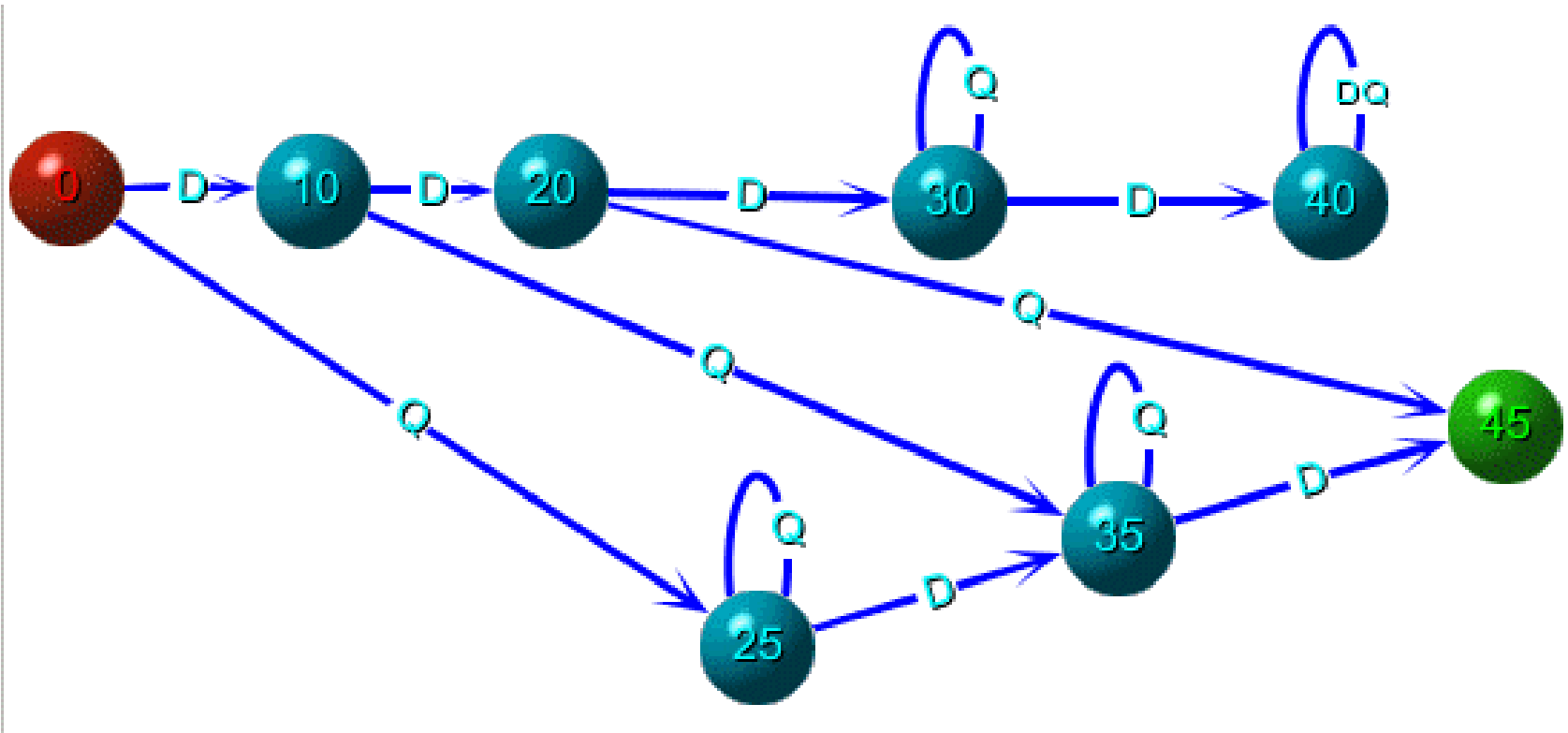

Why was this simpler than Java Code?

- Only needed two coin types “D” and “Q”
 - symbols/letters in alphabet
- Only needed 7 possible current total amounts
 - states/nodes/vertices
- Much cleaner and more aesthetically pleasing than Java lingo
- Next: generalize and abstract...

Alphabets and Strings

- Definitions:
- An **alphabet** Σ is a set of **symbols** (characters, letters).
- A **string** (or word) over Σ is a sequence of symbols.
 - The empty string is the string containing no symbols at all, and is denoted by ε .
 - The length of the string is the number of symbols, e.g. $|\varepsilon| = 0$.

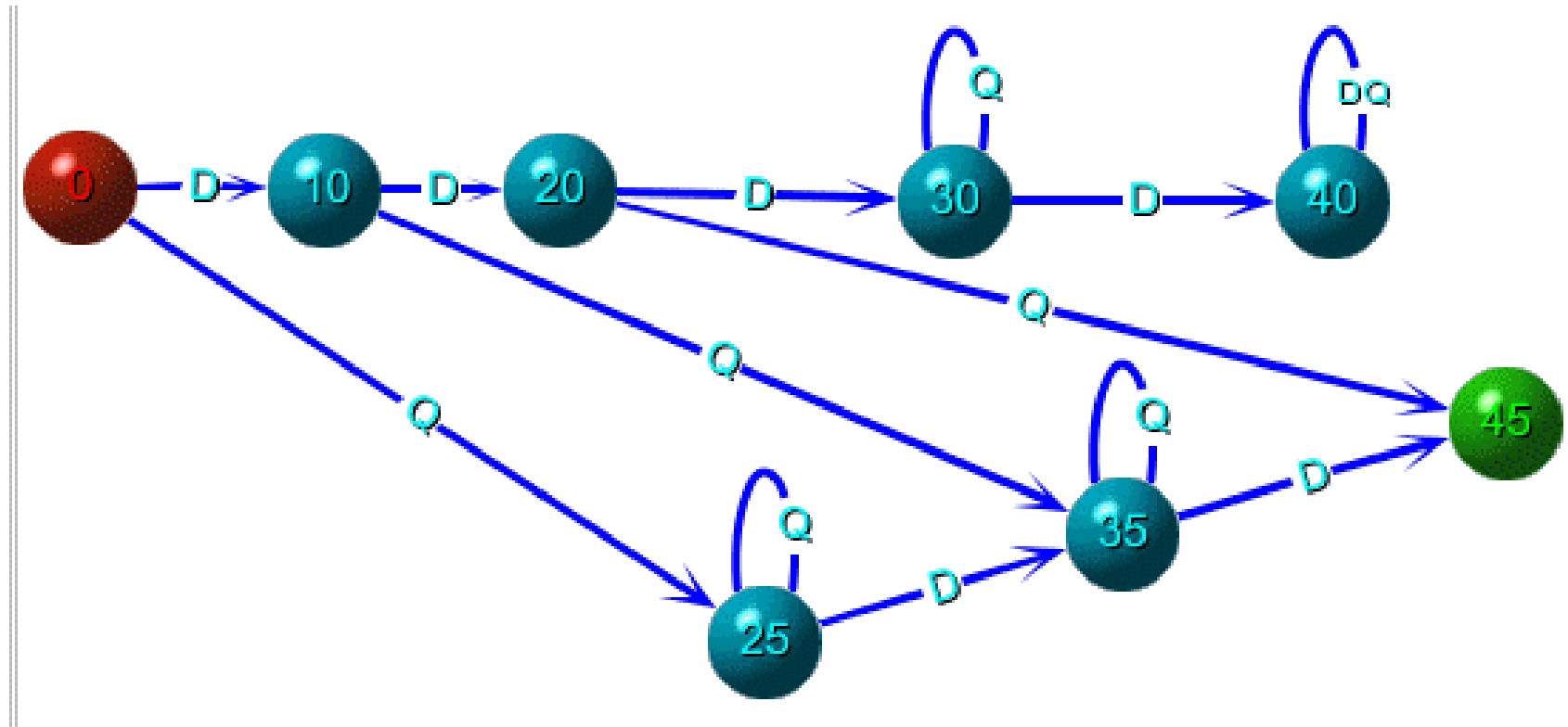

Questions:

- 1) What is Σ ?
- 2) What are some good or bad strings?
- 3) What does ε signify here?

Finite Automaton Example

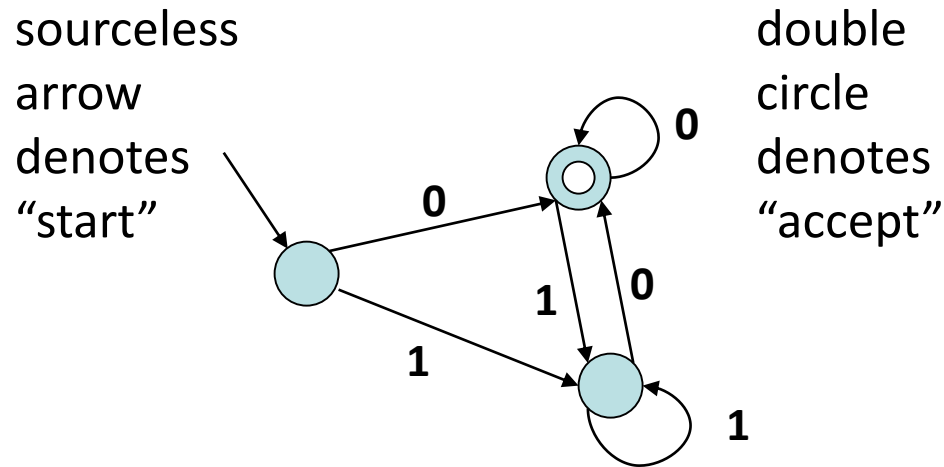

input put
on tape
read left
to right

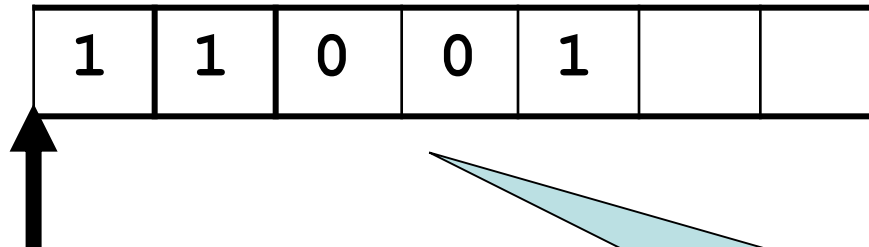

What strings are "accepted"?

Formal Definition of a Finite Automaton

A **finite automaton** (FA) is a 5-tuple $(Q, \Sigma, \delta, q_0, F)$, where

- Q is a finite set called the **states**
- Σ is a finite set called the **alphabet**
- $\delta: Q \times \Sigma \rightarrow Q$ is the **transformation function**
- $q_0 \in Q$ is the **start state**
- $F \subseteq Q$ is the set of **accept states** (a.k.a. final states).

Formal Definition of a Finite Automaton

A **finite automaton** (FA) is a 5-tuple $(Q, \Sigma, \delta, q_0, F)$, where

- Q is a finite set called the **states**
 - Σ is a finite set called the **alphabet**
 - $\delta: Q \times \Sigma \rightarrow Q$ is the **transformation function**
 - $q_0 \in Q$ is the **start state**
 - $F \subseteq Q$ is the set of **accept states** (a.k.a. final states).
-
- The “input string” and the tape containing it are implicit in the definition. The definition only deals with the *static* view.

Further explaining is needed for understanding how FA's interact with their input.

Accept States

- How does an FA operate on strings?

Imagine an auxiliary tape containing the string.

The FA reads the tape from left to right with each new character causing the FA to go into another state.

When the string is completely read, the string is accepted depending on whether the FA's final state was an accept state.

Accept States

- How does an FA operate on strings?

Imagine an auxiliary tape containing the string.

The FA reads the tape from left to right with each new character causing the FA to go into another state.

When the string is completely read, the string is accepted depending on whether the FA's final state was an accept state.

- **Definition:** A string u is **accepted** by an automaton M iff (*if and only if*) the path starting at q_0 which is labeled by u ends in an accept state.

Accept States

- How does an FA operate on strings?

Imagine an auxiliary tape containing the string.

The FA reads the tape from left to right with each new character causing the FA to go into another state.

When the string is completely read, the string is accepted depending on whether the FA's final state was an accept state.

- Definition: A string u is **accepted** by an automaton M iff (*if and only if*) the path starting at q_0 which is labeled by u ends in an accept state.
- This definition is somewhat **informal**. To really define what it means for a string to label a path, you need to break u up into its sequence of characters and apply δ repeatedly, keeping track of states.

Language

- Definition:

The **language** accepted by a finite automaton M is the set of all strings which are accepted by M . The language is denoted by $L(M)$.

We also say that M recognizes $L(M)$, or that M accepts $L(M)$.

- Think of all the possible ways of getting from the start to any accept state.

Language

- Definition:

The **language** accepted by a finite automaton M is the set of all strings which are accepted by M . The language is denoted by $L(M)$.

We also say that M recognizes $L(M)$, or that M accepts $L(M)$.

- Think of all the possible ways of getting from the start to any accept state.
- We will eventually see that not all languages can be described as the accepted language of some FA.
- A language L is called a **regular language** if there exists a FA M that recognizes the language L .

Designing Finite Automata

- This is essentially a creative process...
- “You are the automaton” method
 - Given a language (for which we must design an automaton).
 - Pretending to be automaton, you receive an input string.
 - You get to see the symbols in the string one by one.
 - After each symbol you must determine whether string seen so far is part of the language.
 - Like an automaton, you don’t see the end of the string, so you must always be ready to answer right away.
- Main point: What is crucial, what defines the language?!

Find the automata for...

- 1) $\Sigma = \{0,1\}$,
Language consists of all strings with odd number of ones.
- 2) $\Sigma = \{0,1\}$,
Language consists of all strings with substring "001",
for example 100101, but not 1010110101.

More examples in the book and in the exercises...

Definition of Regular Language

- Recall the definition of a regular language:

A language L is called a **regular language** if there exists a FA M that recognizes the language L .

- We would like to understand what types of languages are regular. Languages of this type are amenable to super-fast recognition.

Definition of Regular Language

- Recall the definition of a regular language:

A language L is called a **regular language** if there exists a FA M that recognizes the language L .

- We would like to understand what types of languages are regular. Languages of this type are amenable to super-fast recognition.
- Are the following languages regular?
 - Unary prime numbers: $\{ 11, 111, 11111, 1111111, 1111111111, \dots \}$
 $= \{ 1^2, 1^3, 1^5, 1^7, 1^{11}, 1^{13}, \dots \} = \{ 1^p \mid p \text{ is a prime number} \}$
 - Palindromic bit strings: $\{ \epsilon, 0, 1, 00, 11, 000, 010, 101, 111, \dots \}$

Finite Languages

- All the previous examples had the following property in common:
infinite cardinality
- Before looking at infinite languages, we should look at finite languages.

Finite Languages

- All the previous examples had the following property in common:
infinite cardinality
- Before looking at infinite languages, we should look at finite languages.
- Question:

Is the singleton language containing one string regular?
For example, is the language {banana} regular?

Languages of Cardinality 1

- Answer: Yes.

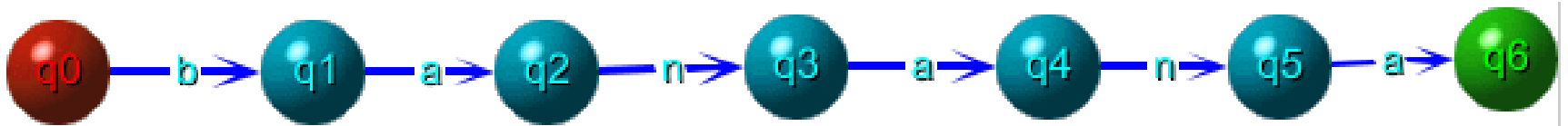

Languages of Cardinality 1

- Answer: Yes.

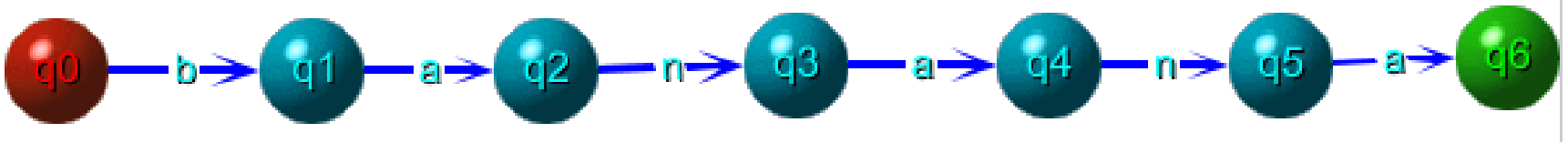

- Question: Huh? What's wrong with this automaton?!?
What if the automation is in state q_1 and reads a "b"?

Languages of Cardinality 1

- Answer: Yes.



- Question: Huh? What's wrong with this automaton?!?
What if the automation is in state q_1 and reads a "b"?

- Answer:

This is a first example of a **nondeterministic** FA. The difference between a deterministic FA (DFA) and a nondeterministic FA (NFA) is that every DFA state has one exiting transition arrow for each symbol of the alphabet.

Languages of Cardinality 1

- Answer: Yes.



- Question: Huh? What's wrong with this automaton?!?
What if the automation is in state q_1 and reads a "b"?

- Answer:

This is a first example of a **nondeterministic** FA. The difference between a deterministic FA (DFA) and a nondeterministic FA (NFA) is that every DFA state has one exiting transition arrow for each symbol of the alphabet.

- Question: Is there a way of fixing it and making it deterministic?

Arbitrary Finite Number of Finite Strings

- Theorem: All finite languages are regular.

Arbitrary Finite Number of Finite Strings

- Theorem: All finite languages are regular.
- Proof:

One can always construct a tree whose leaves are word-ending. Make word endings into accept states, add a fail sink-state and add links to the fail state to finish the construction.

Since there's only a finite number of finite strings, the automaton is finite.

Regular Operations

- You may have come across the regular operations when doing advanced searches utilizing programs such as **emacs**, **egrep**, **perl**, **python**, etc.
- There are four **basic operations** we will work with:
 - Union
 - Concatenation
 - Kleene-Star
 - Kleene-Plus (which can be defined using the other three)

Regular Operations – Summarizing Table

Operation	Symbol	UNIX version	Meaning
Union	U		Match one of the patterns
Concatenation	•	<i>implicit in UNIX</i>	Match patterns in sequence
Kleene-star	*	*	Match pattern 0 or more times
Kleene-plus	+	+	Match pattern 1 or more times

Regular Operations matters!

The screenshot shows the Glassdoor website interface. At the top, there is a green navigation bar with the Glassdoor logo and links for Jobs, Companies, Salaries, and Interviews. A search bar is located on the right side of this bar. Below the navigation bar is the profile header for Google, featuring the Google logo, the name "Google", and the website "www.google.com". A "See all Photos" button is visible in the top right corner of the profile header. Below the header, there are statistics for the company: 4.0k Reviews, 12k Salaries, and 4.6k Interviews. The "Interviews" category is highlighted with a blue underline. To the right of these statistics are buttons for "Follow" and "+ Add Interview". Below the statistics is a section titled "Interview Question" for an interview in Dublin, Co. Dublin (Ireland). The question text reads: "regular expression for IP address. Although I gave him answer, the interviewer asked me questions for nearly one hour on this topic". Below the question, there are links for "Answer" and "Add Tags". At the bottom left, there is a breadcrumb trail: "Interviews > SRE > Google". A small icon of a document with a checkmark is visible in the bottom right corner of the question section.

glassdoor Jobs Companies Salaries Interviews Search...

 **Google**
www.google.com Engaged Employer

 **4.0k** Reviews **12k** Salaries **4.6k** Interviews **Follow** **+ Add Interview**

Interview Question
Interview Dublin, Co. Dublin (Ireland)

"regular expression for IP address. Although I gave him answer, the interviewer asked me questions for nearly one hour on this topic"

Answer | Add Tags ▶ 

Interviews > SRE > Google

Regular operations: Union

- In UNIX, to search for all lines containing vowels in a text one could use the command
 - `egrep -i `a|e|i|o|u``
 - Here the pattern “*vowel*” is matched by any line containing a vowel.
 - A good way to define a pattern is as a set of strings, i.e. a language. The language for a given pattern is the set of all strings satisfying the predicate of the pattern.

Regular operations: Union

- In UNIX, to search for all lines containing vowels in a text one could use the command
 - `egrep -i `a|e|i|o|u``
 - Here the pattern “*vowel*” is matched by any line containing a vowel.
 - A good way to define a pattern is as a set of strings, i.e. a language. The language for a given pattern is the set of all strings satisfying the predicate of the pattern.
- In UNIX, a pattern is implicitly assumed to occur as a substring of the matched strings. In our course, however, a pattern needs to specify **the whole string**, not just a substring.

Regular operations: Union

- In UNIX, to search for all lines containing vowels in a text one could use the command
 - `egrep -i `a|e|i|o|u``
 - Here the pattern “*vowel*” is matched by any line containing a vowel.
 - A good way to define a pattern is as a set of strings, i.e. a language. The language for a given pattern is the set of all strings satisfying the predicate of the pattern.
- In UNIX, a pattern is implicitly assumed to occur as a substring of the matched strings. In our course, however, a pattern needs to specify **the whole string**, not just a substring.
- **Computability: Union is exactly what we expect.**
If you have patterns $A = \{\text{aardvark}\}$, $B = \{\text{bobcat}\}$, $C = \{\text{chimpanzee}\}$, the union of these is $A \cup B \cup C = \{\text{aardvark, bobcat, chimpanzee}\}$.

Regular operations: Concatenation

- To search for all consecutive double occurrences of vowels, use:
 - `egrep -i `(a|e|i|o|u)(a|e|i|o|u)``
 - Here the pattern “*vowel*” has been repeated. Parentheses have been introduced to specify where exactly in the pattern the concatenation is occurring.

Regular operations: Concatenation

- To search for all consecutive double occurrences of vowels, use:
 - `egrep -i `(a|e|i|o|u)(a|e|i|o|u)``
 - Here the pattern “*vowel*” has been repeated. Parentheses have been introduced to specify where exactly in the pattern the concatenation is occurring.
- Computability: Consider the previous result:
 $L = \{\text{aardvark, bobcat, chimpanzee}\}$.

When we concatenate L with itself we obtain:

$$L \bullet L = \{\text{aardvark, bobcat, chimpanzee}\} \bullet \{\text{aardvark, bobcat, chimpanzee}\} =$$

{aardvarkaardvark, aardvarkbobcat, aardvarkchimpanzee,
bobcataardvark, bobcatbobcat, bobcatchimpanzee,
chimpanzeeaardvark, chimpanzeebobcat, chimpanzeechimpanzee}

Regular operations: Kleene-*

- We continue the UNIX example: now search for lines consisting purely of vowels (including the empty line):
 - `egrep -i `^(a|e|i|o|u)*$``
 - Note: ^ and \$ are special symbols in UNIX regular expressions which respectively anchor the pattern at the *beginning* and *end* of a line. The trick above can be used to convert any Computability regular expression into an equivalent UNIX form.

Regular operations: Kleene-*

- We continue the UNIX example: now search for lines consisting purely of vowels (including the empty line):
 - `egrep -i `^(a|e|i|o|u)*$``
 - Note: `^` and `$` are special symbols in UNIX regular expressions which respectively anchor the pattern at the *beginning* and *end* of a line. The trick above can be used to convert any Computability regular expression into an equivalent UNIX form.
- **Computability:** Suppose we have a language $B = \{ba, na\}$.
Question: What is the language B^* ?

Regular operations: Kleene-*

- We continue the UNIX example: now search for lines consisting purely of vowels (including the empty line):
 - `egrep -i `^(a|e|i|o|u)*$``
 - Note: `^` and `$` are special symbols in UNIX regular expressions which respectively anchor the pattern at the *beginning* and *end* of a line. The trick above can be used to convert any Computability regular expression into an equivalent UNIX form.
- Computability: Suppose we have a language $B = \{ba, na\}$.
Question: What is the language B^* ?
- Answer: $B^* = \{ba, na\}^* = \{\epsilon, ba, na, baba, bana, naba, nana, bababa, babana, banaba, banana, nababa, nabana, nanaba, nanana, babababa, bababana, \dots\}$

Regular operations: Kleene-+

- Kleene-+ is just like Kleene-* except that the pattern is forced to occur *at least once*.
- UNIX: search for lines consisting purely of vowels (not including the empty line):
 - `egrep -i `^(a|e|i|o|u)+$``

Regular operations: Kleene-+

- Kleene-+ is just like Kleene-* except that the pattern is forced to occur *at least once*.
- UNIX: search for lines consisting purely of vowels (not including the empty line):

```
- egrep -i `^(a|e|i|o|u)+$`
```

- Computability:

Suppose we have a language $B = \{ba, na\}$.
What is B^+ and how does it differ from B^* ?

Regular operations: Kleene-+

- Kleene-+ is just like Kleene-* except that the pattern is forced to *occur at least once*.
- UNIX: search for lines consisting purely of vowels (not including the empty line):

```
- egrep -i `^(a|e|i|o|u)+$`
```

- Computability:

Suppose we have a language $B = \{ba, na\}$.

What is B^+ and how does it differ from B^* ?

$B^+ = \{ba, na\}^+ = \{ba, na, baba, bana, naba, nana, bababa, babana, banaba, banana, nababa, nabana, nanaba, nanana, babababa, bababana, \dots\}$

The only difference is the absence of ϵ

Closure of Regular Languages

- When applying regular operations to regular languages, regular languages result. That is, regular languages are **closed** under the operations of *union*, *concatenation*, and *Kleene-**.
- Goal: Show that regular languages are *closed* under regular operations. In particular, given regular languages L_1 and L_2 , show:
 1. $L_1 \cup L_2$ is regular,
 2. $L_1 \bullet L_2$ is regular,
 3. L_1^* is regular.
- No.'s 2 and 3 are deferred until we learn about NFA's.
- However, No. 1 can be achieved immediately.

Union Example

- Problem: Draw the FA for

$$L = \{x \in \{0,1\}^* \mid |x|=\text{even or } x \text{ ends with } 11\}$$

Let's start by drawing M_1 and M_2 ,
the automaton recognizing L_1 and L_2

- $L_1 = \{x \in \{0,1\}^* \mid x \text{ has even length}\}$

- $L_2 = \{x \in \{0,1\}^* \mid x \text{ ends with } 11 \}$

Cartesian Product Construction

- We want to construct a finite automaton M that recognizes any strings belonging to L_1 or L_2 .
- Idea: Build M such that it simulates *both* M_1 and M_2 simultaneously and accept if either of the automata accepts

Cartesian Product Construction

- We want to construct a finite automaton M that recognizes any strings belonging to L_1 or L_2 .
- Idea: Build M such that it simulates *both* M_1 and M_2 simultaneously and accept if either of the automata accepts
- Definition: The **Cartesian product** of two sets A and B , denoted by $A \times B$, is the set of all ordered pairs (a,b) where $a \in A$ and $b \in B$.

Formal Definition

- Given two automata

$$M_1 = (Q_1, \Sigma, \delta_1, q_1, F_1) \text{ and } M_2 = (Q_2, \Sigma, \delta_2, q_2, F_2)$$

- Define the **unioner** of M_1 and M_2 by:

$$M_U = (Q_1 \times Q_2, \Sigma, \delta_1 \times \delta_2, (q_1, q_2), F_U)$$

- where the accept state (q_1, q_2) is the combined start state of both automata

- where F_U is the set of ordered pairs in $Q_1 \times Q_2$ with at least one state an accept state. That is: $F_U = Q_1 \times F_2 \cup F_1 \times Q_2$

- where the transition function δ is defined as

$$\delta((q_1, q_2), j) = (\delta_1(q_1, j), \delta_2(q_2, j)) = \delta_1 \times \delta_2$$

Union Example: $L_1 \cup L_2$

- When using the **Cartesian Product Construction**:

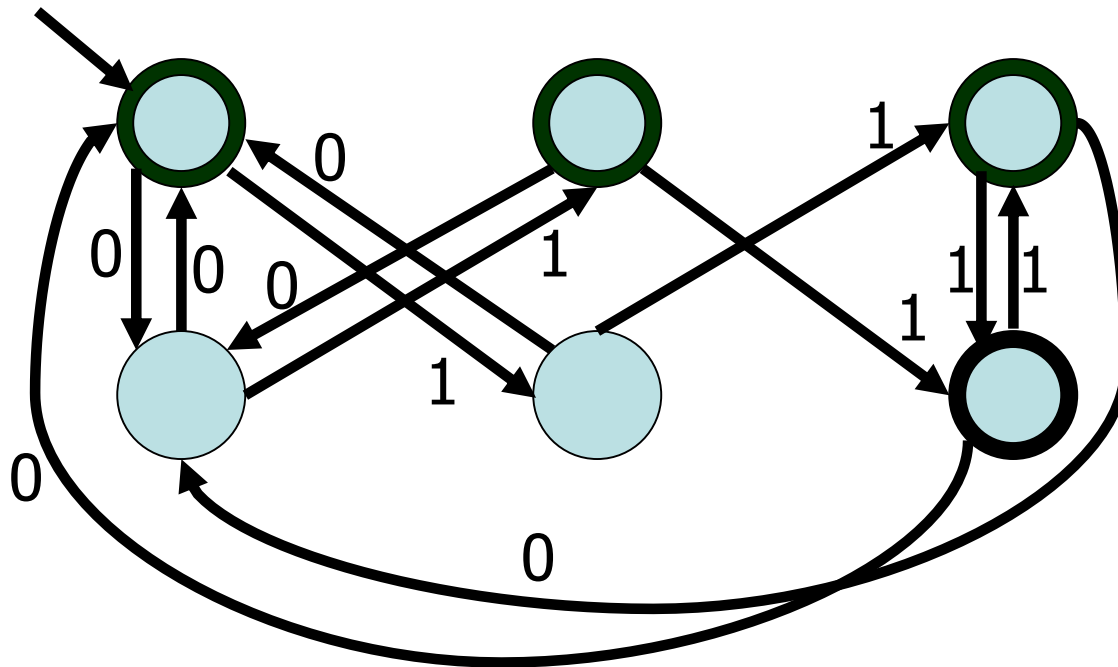

Other constructions: Intersector

- Other constructions are possible, for example an **intersector**:
- Accept only when both ending states are accept states. So the only difference is in the set of accept states. Formally the intersector of M_1 and M_2 is given by
$$M_{\cap} = (Q_1 \times Q_2, \Sigma, \delta_1 \times \delta_2, (q_{0,1}, q_{0,2}), F_{\cap}), \text{ where } F_{\cap} = F_1 \times F_2.$$

Other constructions: Intersector

- Other constructions are possible, for example an **intersector**:
- Accept only when both ending states are accept states. So the only difference is in the set of accept states. Formally the intersector of M_1 and M_2 is given by $M_{\cap} = (Q_1 \times Q_2, \Sigma, \delta_1 \times \delta_2, (q_{0,1}, q_{0,2}), F_{\cap})$, where $F_{\cap} = F_1 \times F_2$.

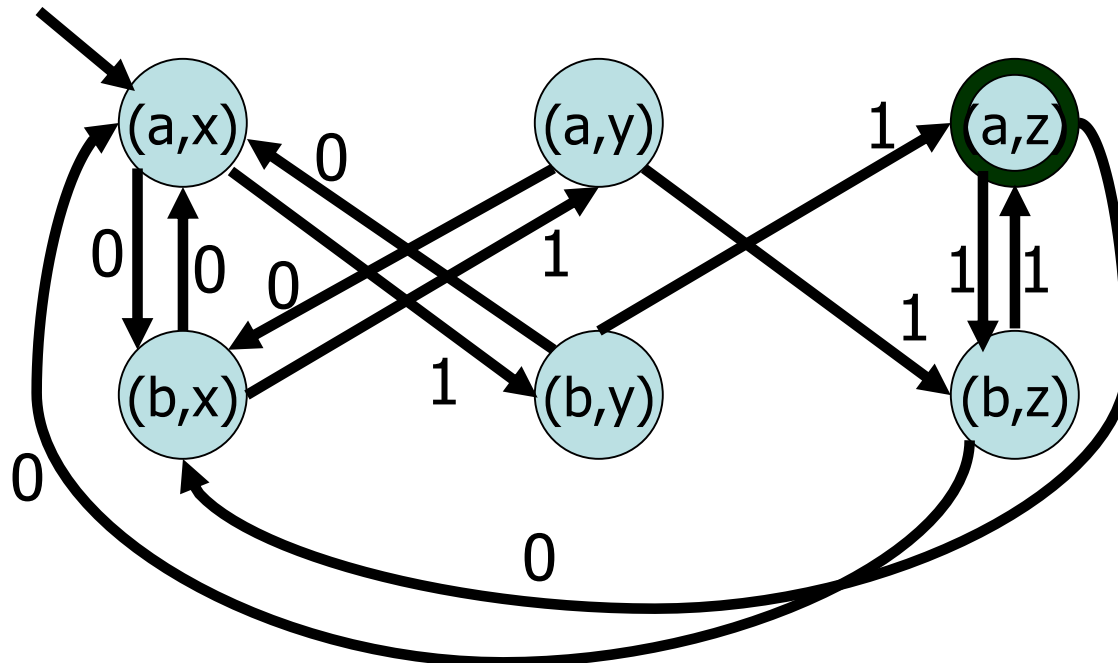

Other constructions: Difference

- The **difference** of two sets is defined by $A - B = \{x \in A \mid x \notin B\}$
- In other words, accept when first automaton accepts and second does not

$$M_- = (Q_1 \times Q_2, \Sigma, \delta_1 \times \delta_2, (q_{0,1}, q_{0,2}), F_-),$$

where $F_- = F_1 \times Q_2 - Q_1 \times F_2$

Other constructions: Difference

- The **difference** of two sets is defined by $A - B = \{x \in A \mid x \notin B\}$
- In other words, accept when first automaton accepts and second does not

$$M_- = (Q_1 \times Q_2, \Sigma, \delta_1 \times \delta_2, (q_{0,1}, q_{0,2}), F_-),$$

where $F_- = F_1 \times Q_2 - Q_1 \times F_2$

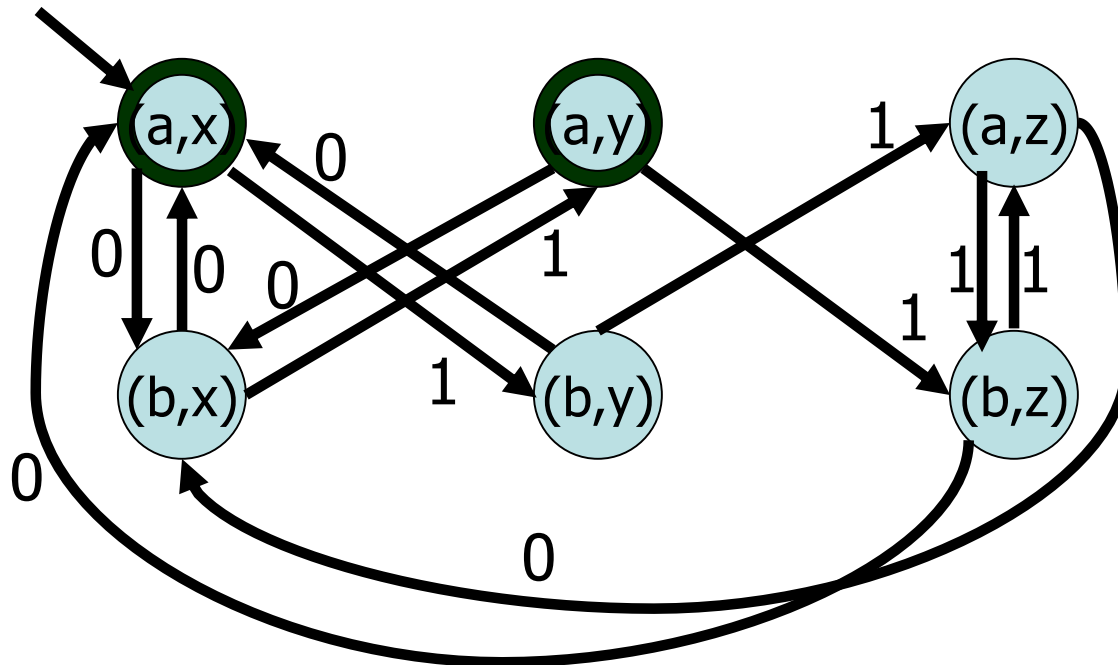

Other constructions: Symmetric difference

- The **symmetric difference** of two sets A, B is $A \oplus B = A \cup B - A \cap B$
- Accept when exactly one automaton accepts:

$$M_{\oplus} = (Q_1 \times Q_2, \Sigma, \delta_1 \times \delta_2, (q_{0,1}, q_{0,2}), F_{\oplus}), \text{ where } F_{\oplus} = F_U - F_{\cap}$$

Other constructions: Symmetric difference

- The **symmetric difference** of two sets A, B is $A \oplus B = A \cup B - A \cap B$
- Accept when exactly one automaton accepts:

$M_{\oplus} = (Q_1 \times Q_2, \Sigma, \delta_1 \times \delta_2, (q_{0,1}, q_{0,2}), F_{\oplus})$, where $F_{\oplus} = F_U - F_{\cap}$

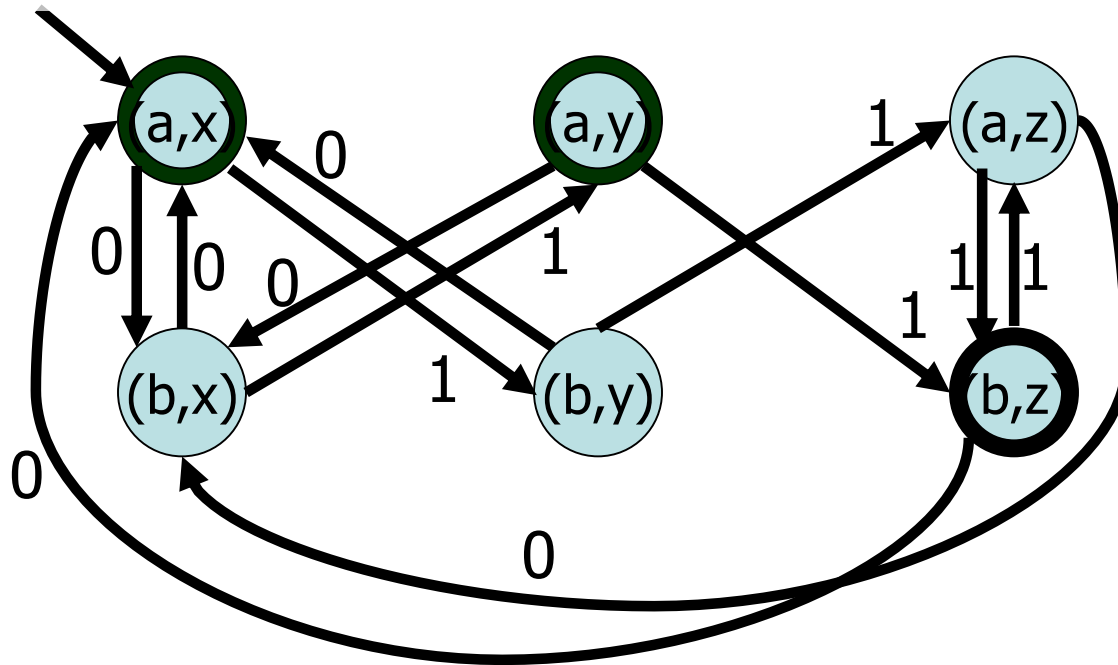

Complement

- How about the **complement**? The complement is only defined with respect to some universe.
- Given the alphabet Σ , the *default universe* is just the set of all possible strings Σ^* . Therefore, given a language L over Σ , i.e. $L \subseteq \Sigma^*$ the complement of L is $\Sigma^* - L$
- Note: Since we know how to compute set difference, and we know how to construct the automaton for Σ^* we can construct the automaton for \bar{L} .

Complement

- How about the **complement**? The complement is only defined with respect to some universe.
- Given the alphabet Σ , the *default universe* is just the set of all possible strings Σ^* . Therefore, given a language L over Σ , i.e. $L \subseteq \Sigma^*$ the complement of L is $\Sigma^* - L$
- Note: Since we know how to compute set difference, and we know how to construct the automaton for Σ^* we can construct the automaton for \bar{L} .
- Question: Is there a simpler construction for \bar{L} ?

Complement

- How about the **complement**? The complement is only defined with respect to some universe.
- Given the alphabet Σ , the *default universe* is just the set of all possible strings Σ^* . Therefore, given a language L over Σ , i.e. $L \subseteq \Sigma^*$ the complement of L is $\Sigma^* - L$
- Note: Since we know how to compute set difference, and we know how to construct the automaton for Σ^* we can construct the automaton for \bar{L} .
- Question: Is there a simpler construction for \bar{L} ?
- Answer: Just switch accept-states with non-accept states.

Complement Example

Original:

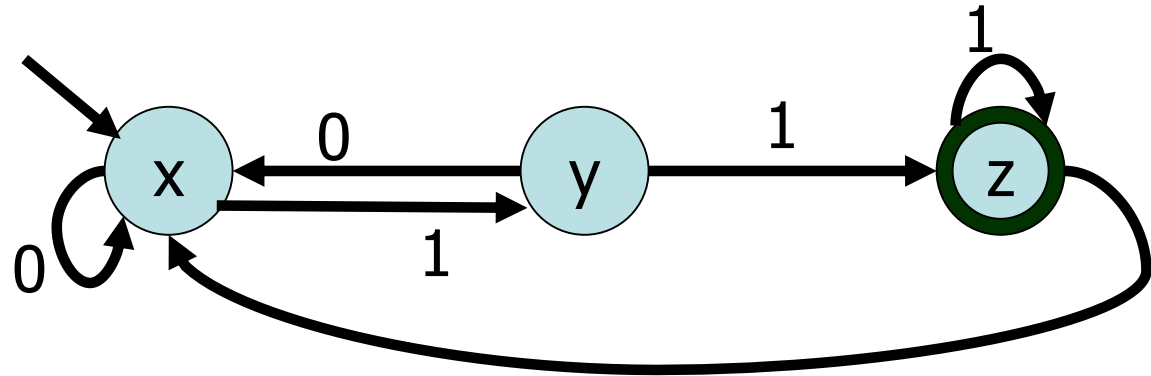

Complement:

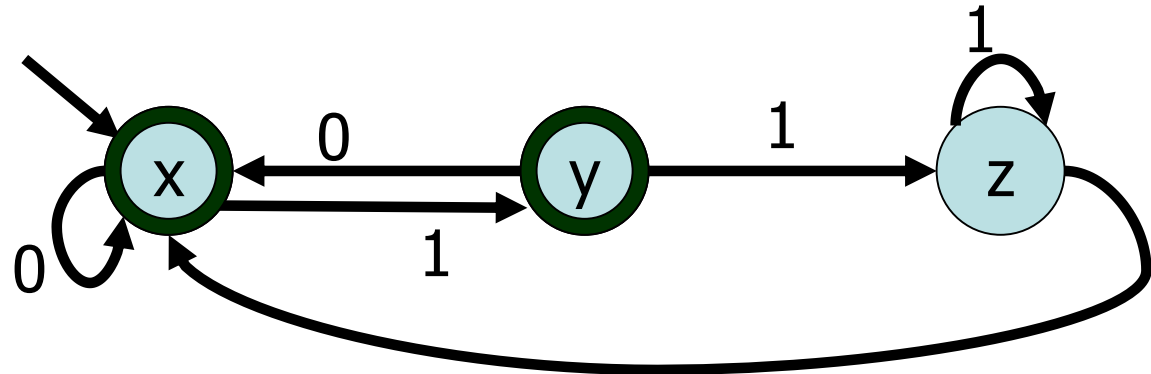

Boolean-Closure Summary

- We have shown **constructively** that regular languages are closed under boolean operations. I.e., given regular languages L_1 and L_2 we saw that:
 1. $L_1 \cup L_2$ is regular,
 2. $L_1 \cap L_2$ is regular,
 3. $L_1 - L_2$ is regular,
 4. $L_1 \oplus L_2$ is regular,
 5. $\overline{L_1}$ is regular.
- No. 2 to 4 also happen to be regular operations. We still need to show that regular languages are closed under concatenation and Kleene- $*$.
- Tough question: Can't we do a similar trick for concatenation?