



SpiderBat: Augmenting Wireless Sensor Networks with Distance and Angle Information

Georg Oberholzer, Philipp Sommer, Roger Wattenhofer



Location in Wireless Sensor Networks

- Context of sensor readings
 - <location, time, value>
- Leverage location information
 - Network layer: geographic routing
 - Physical layer: transmission power control
- Learn about the current node position
 - Nodes might be attached to moving objects

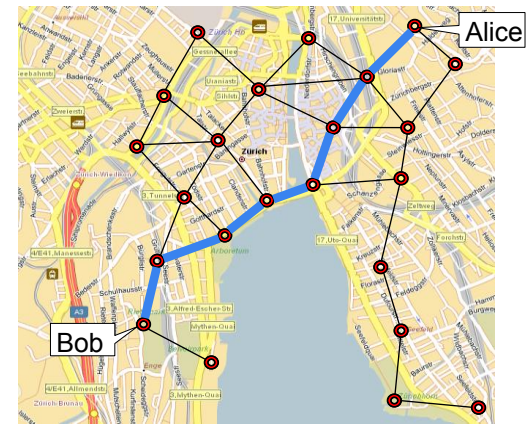

Learning the Position of Sensor Nodes

- Global Positioning System (GPS)

 - Not for indoor applications

 - Special hardware required

 - High power consumption



- Radio-based (connectivity/signal strength)

 - High node density required

 - Limited accuracy (multipath effects)

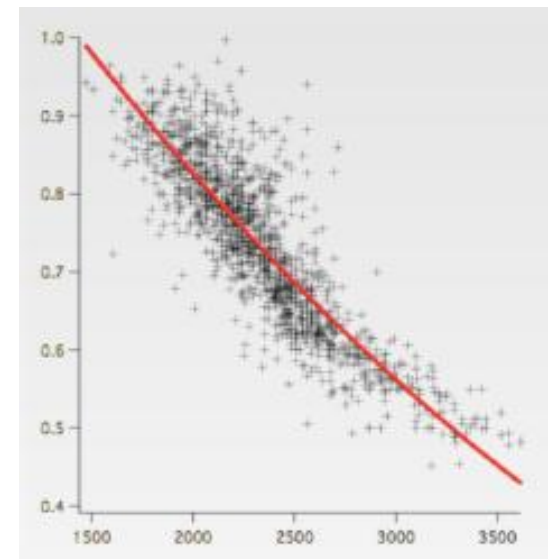

Positioning with Ultrasound

- Inspired by nature ...



20 – 120,000 Hz

- Human hearing range: 20 – 20,000 Hz

Ultrasound meets Sensor Networks

- High accuracy

Speed of sound $c = 343$ m/s

	TelosB/Tmote Sky	MicaZ/IRIS
Clock speed	32 kHz	1 MHz
Resolution	1.04 cm	0.343 mm

- Low complexity

Simple analog circuits for signal processing and peak detection

- Energy efficiency

Short pulses (e.g. 250 microseconds)

Duty-cycling ultrasound transmitter/receivers

Related Work

Cricket

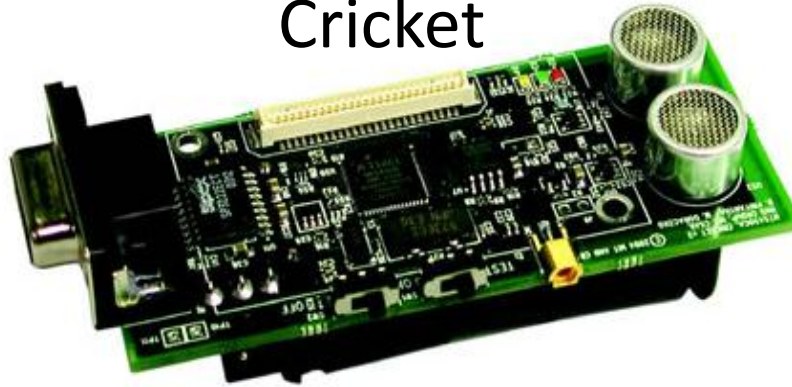

[Priyantha et al., 2000]

Medusa



[Savvides et al., 2001]

Calamari

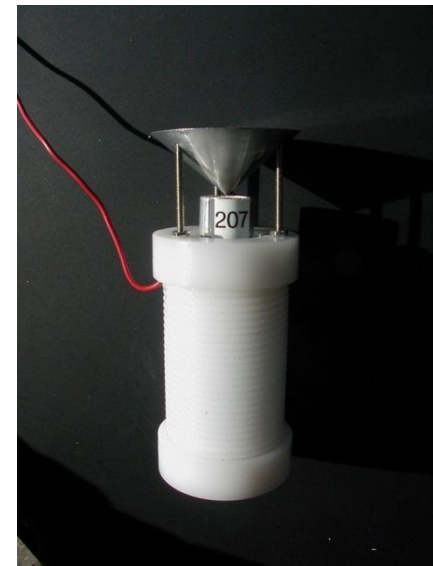

[Whitehouse et al., 2004]

Ultrasound Ranging

- Time difference of arrival (TDoA) between radio and ultrasound:
 - Radio packet wakes up ultrasound receivers
 - Ultrasound pulse is sent after a constant delay

$$c_{\text{radio}} \approx 2.99 \cdot 10^8 \frac{\text{m}}{\text{s}}$$

$$c_{\text{sound}} \approx 343.2 \frac{\text{m}}{\text{s}}$$

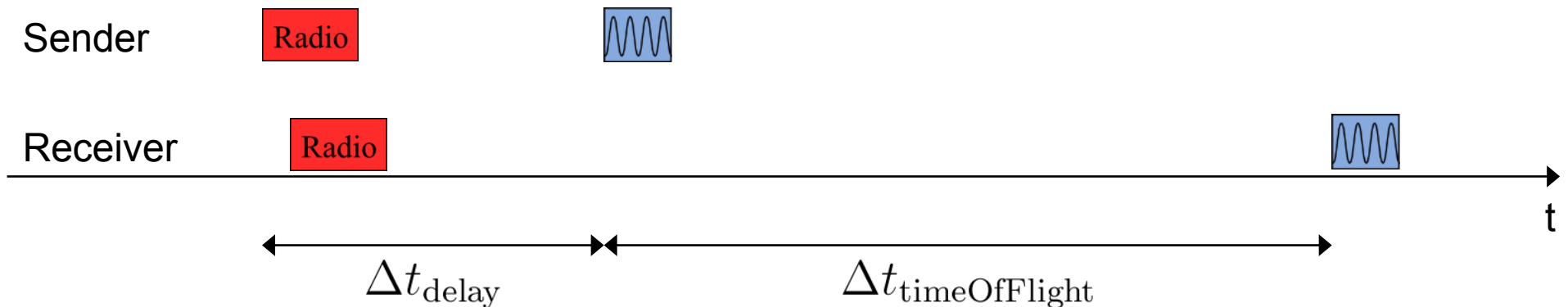

$$d = c_{\text{sound}} \cdot \Delta t_{\text{timeOfFlight}}$$

Distance based Positioning in Sensor Networks

- Determine position based on distances to anchor nodes (trilateration)

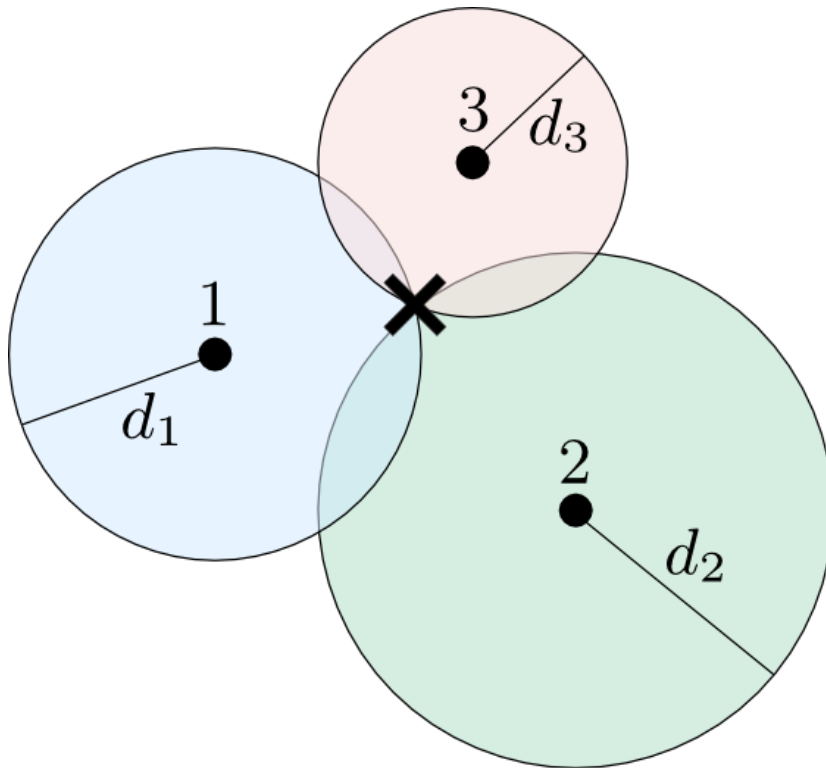

3 anchor nodes

Positioning in Sparse Networks

- How does angle information help to position nodes?

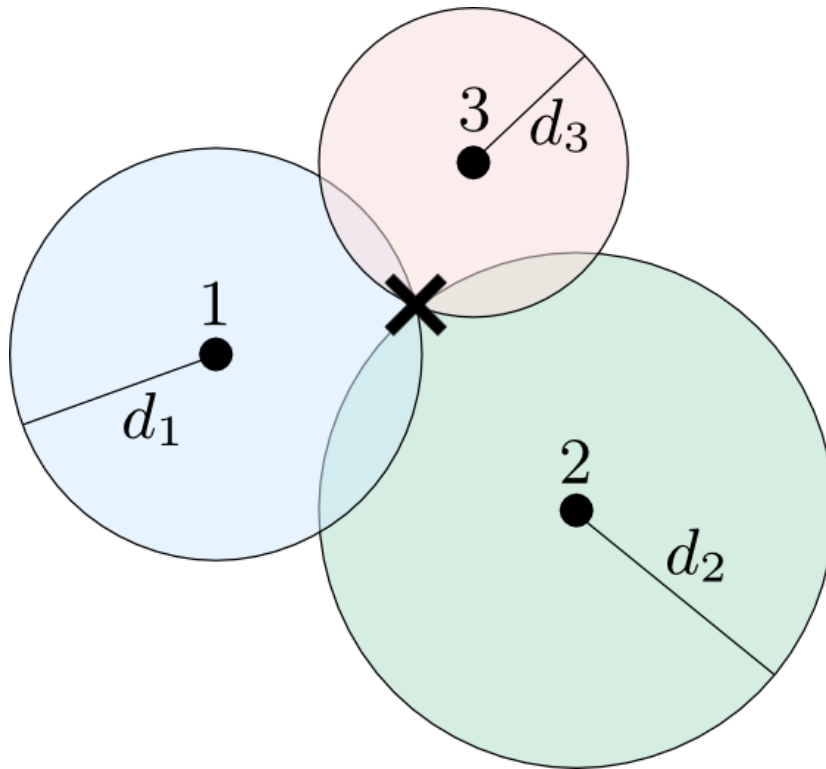

3 anchor nodes

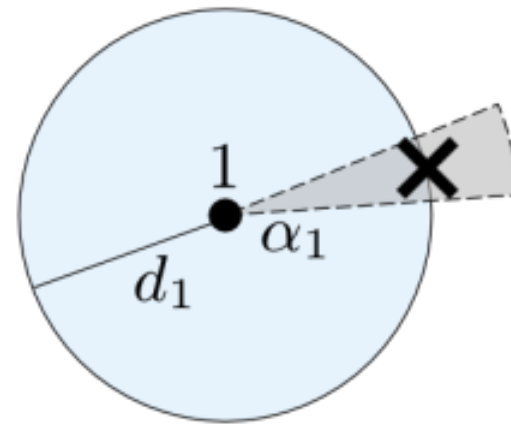

1 anchor node

The SpiderBat Ultrasound Platform

4x Ultrasound Receivers
@ 40 kHz

6.5 cm
(2.56 inches)

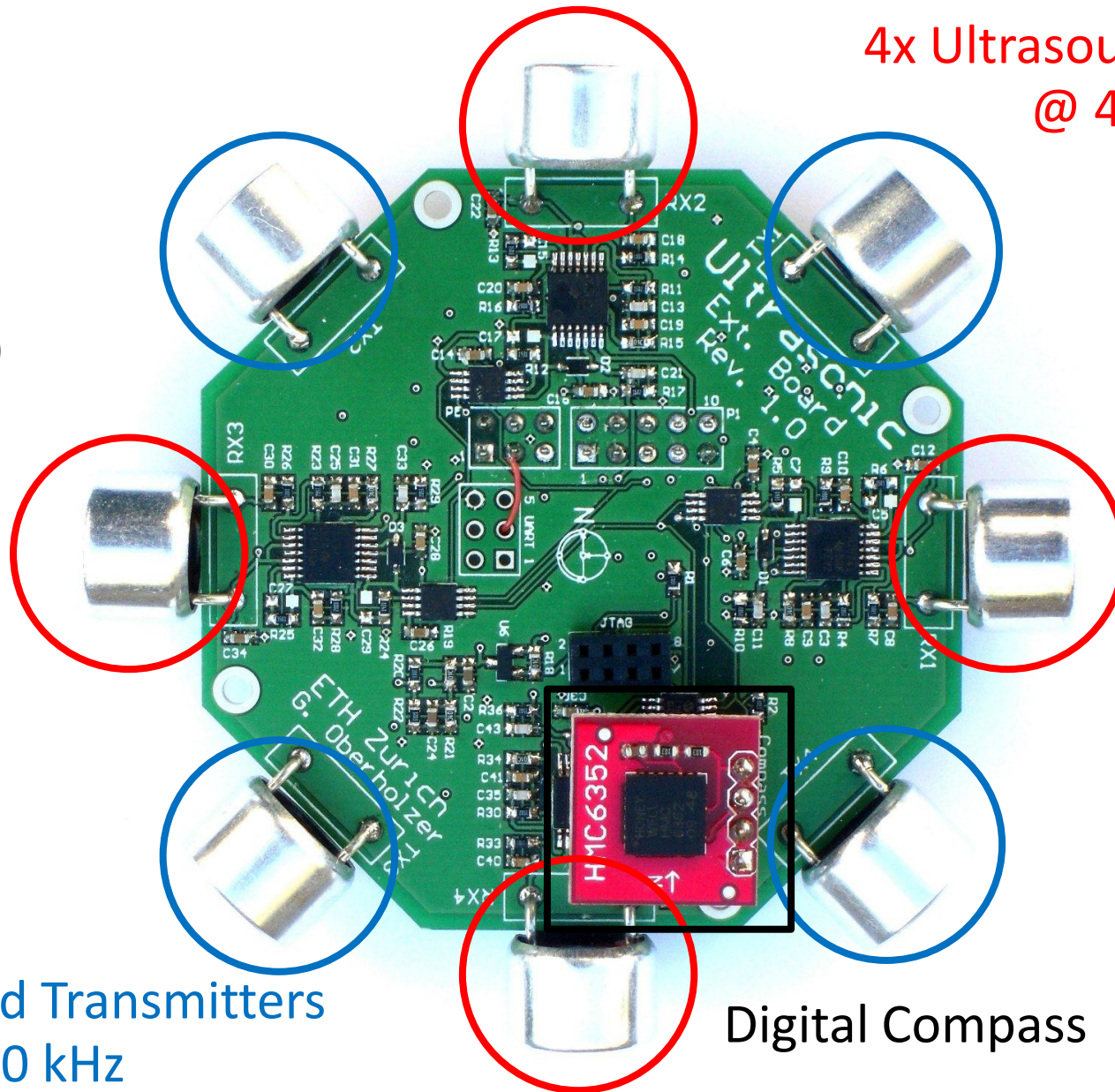

4x Ultrasound Transmitters
@ 40 kHz

Digital Compass

System Architecture

- SpiderBat is an extension board for wireless sensor nodes

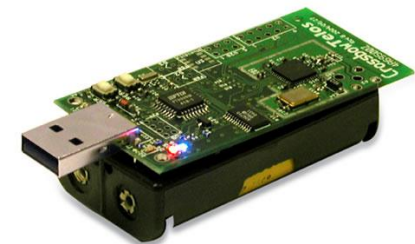
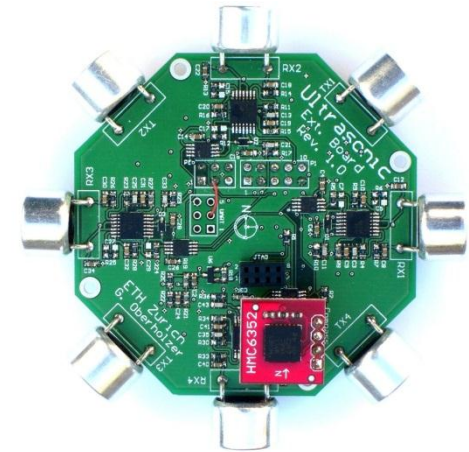
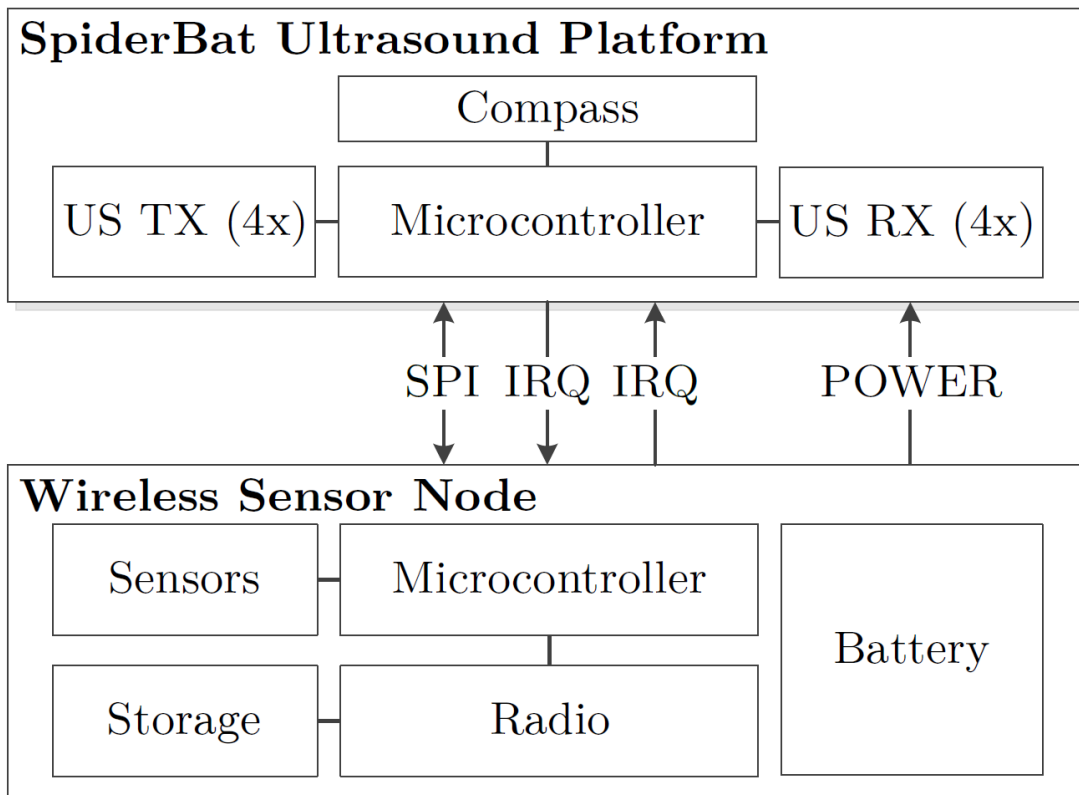

Ultrasound Receiver Circuits

- Three amplification stages with a total gain of 58-75 dB
- Each receiver provides two output signals:
 1. Digital comparator output generates an interrupt signal (RX_INT)
 2. Analog signal output (RX_ADC)

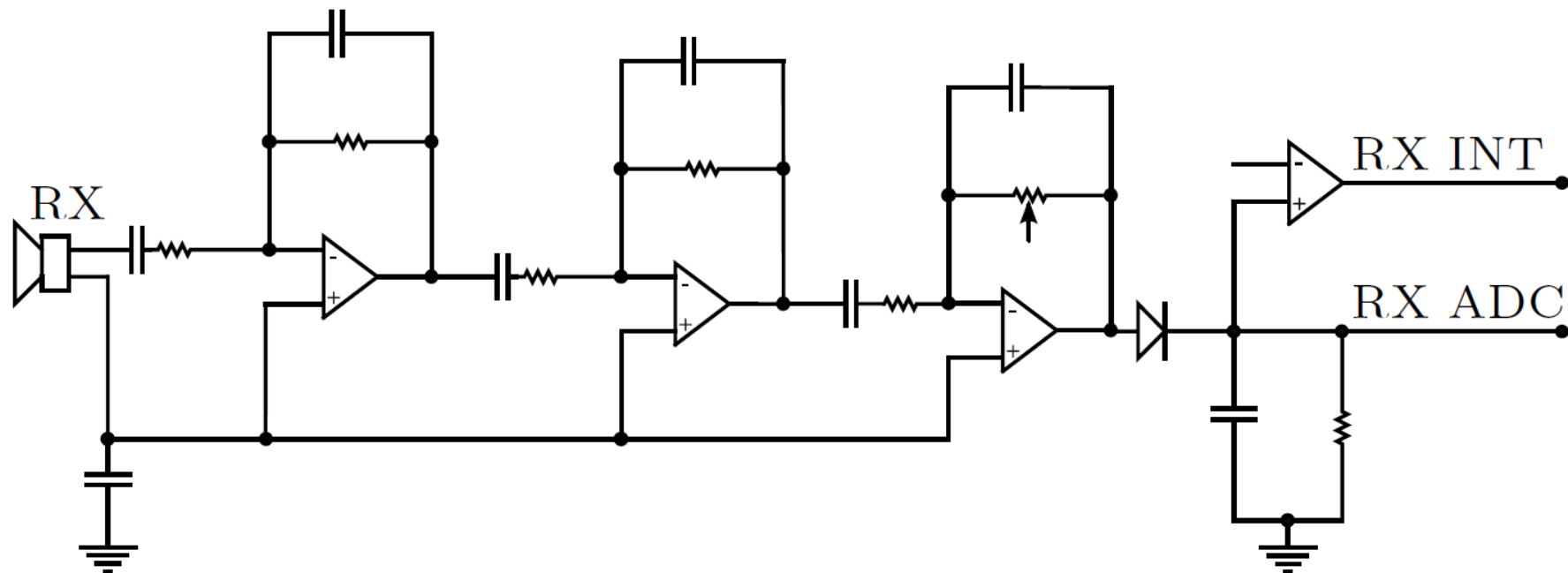

Experimental Evaluation

- Prototype Hardware

 - SpiderBat extension board

 - Atmel ZigBit900 (Atmega1281 MCU + RF212 radio)

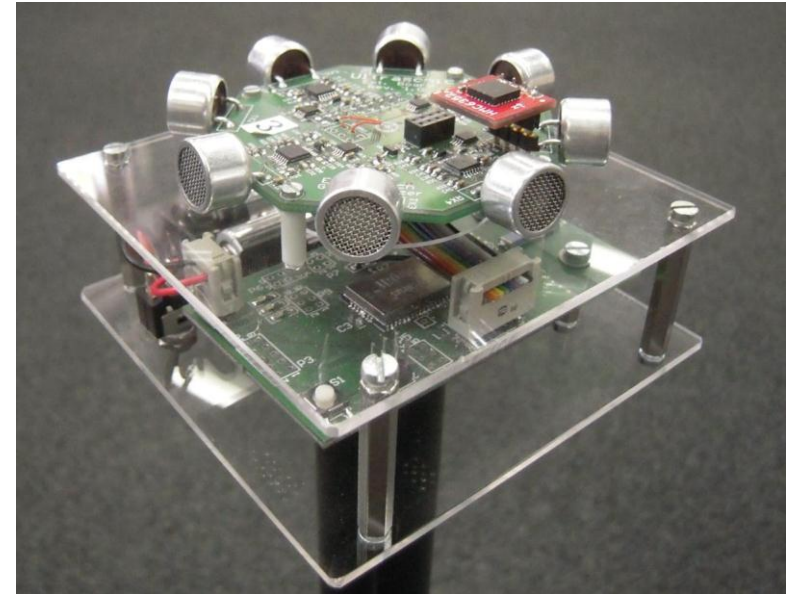

- Software

 - Ultrasound ranging application implemented in TinyOS 2.1

 - Distance/angle/compass information forwarded to a base station



Accuracy of Distance Measurements

- Measurement errors are in the order of a few millimeters

Std. dev of error is 5.39 mm (0.21 inch) at 14 m (45.9 feet)

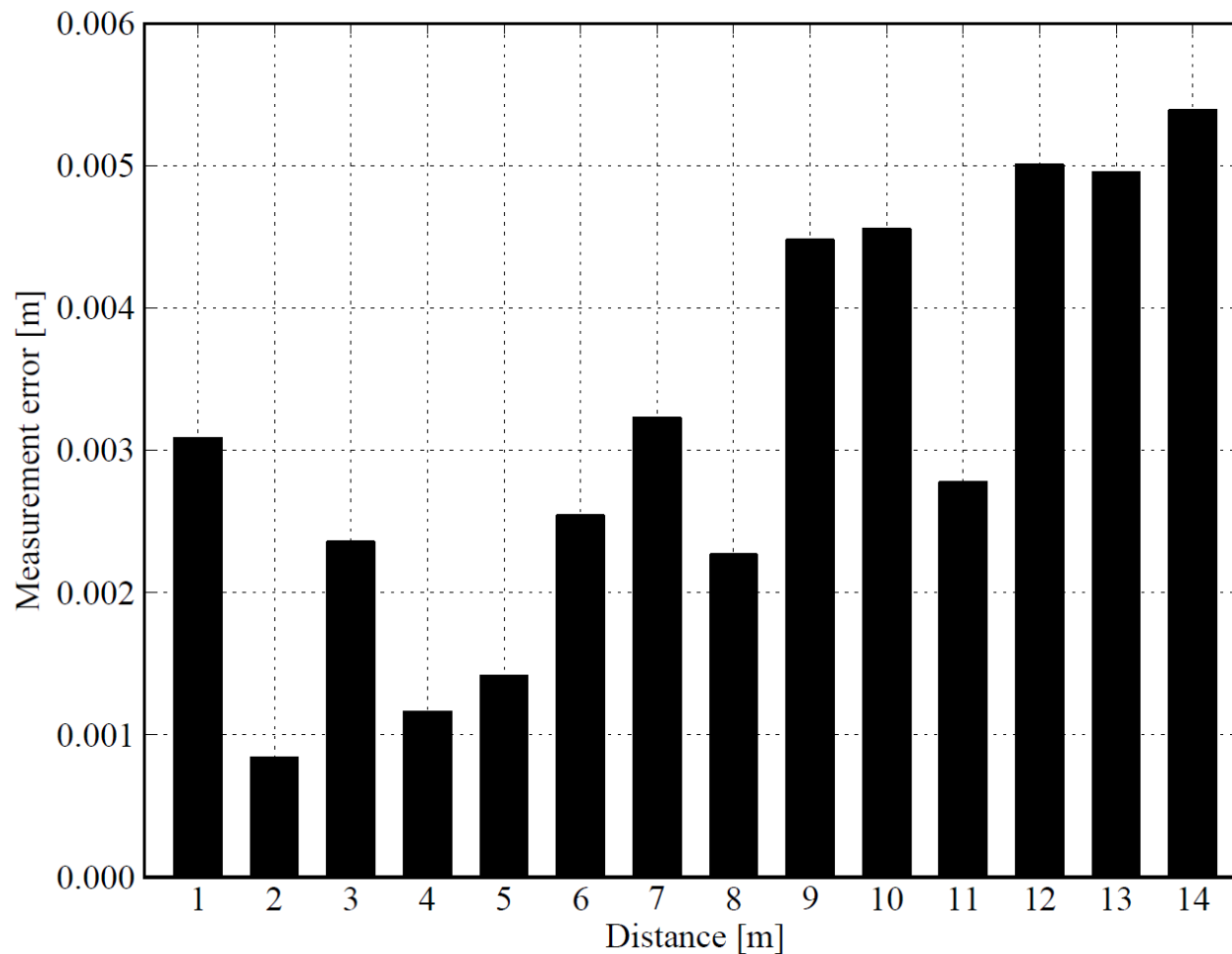

Angle-of-Arrival Measurements with SpiderBat

Receiver

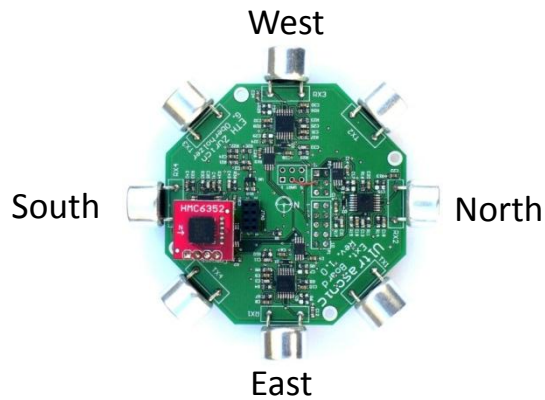

Sender

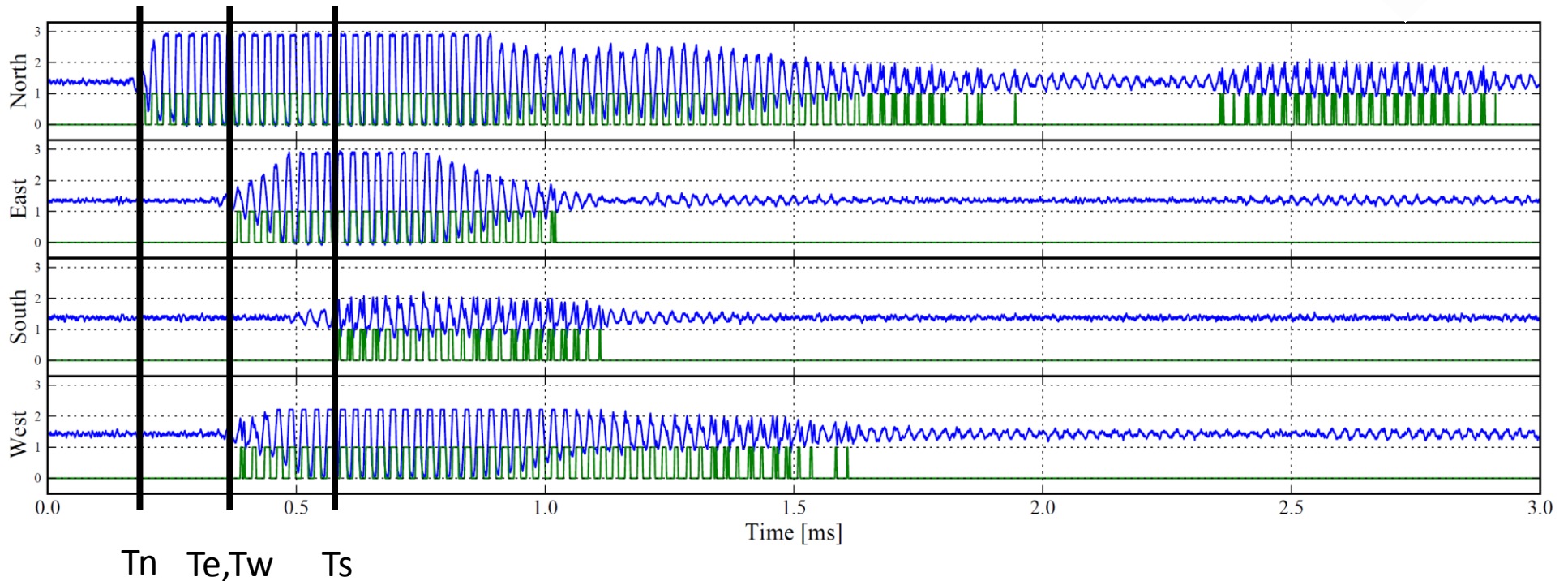
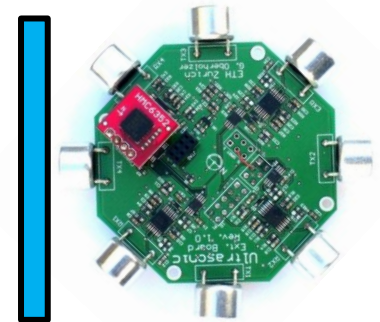

Angle-of-Arrival Estimation

- We can calculate the angle based on the TDoA at the receivers

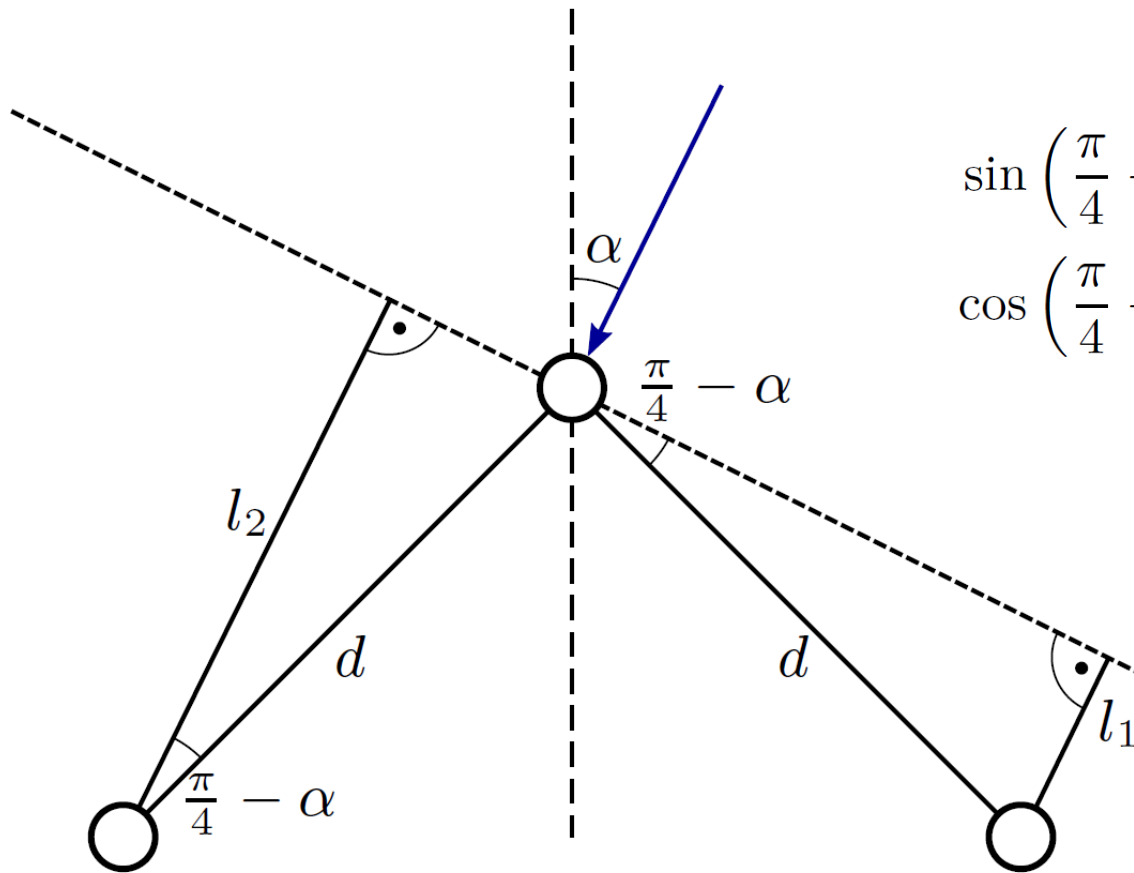

$$\sin\left(\frac{\pi}{4} - \alpha\right) = \frac{l_1}{d} = \frac{c \cdot \Delta t_1}{d}$$

$$\cos\left(\frac{\pi}{4} - \alpha\right) = \frac{l_2}{d} = \frac{c \cdot \Delta t_2}{d}$$

$$\alpha = \frac{\pi}{4} - \arctan\left(\frac{\Delta t_1}{\Delta t_2}\right)$$

Accuracy of Angle Measurements

- Estimation of the angle-of-arrival within a few degrees

Error is less than 5° for short distances between sender and receiver

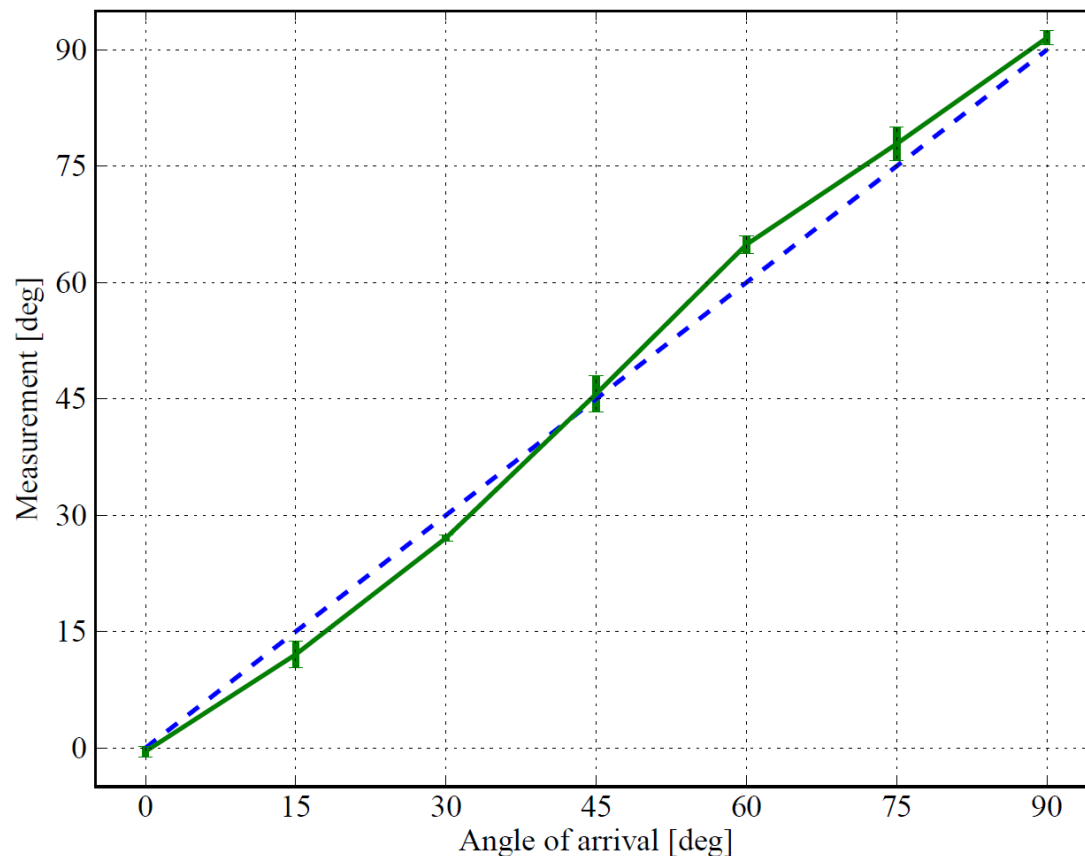

Indoor Experiments

- 4 nodes placed in a gym hall, single anchor node (Node 1)
- 200 measurements for each node

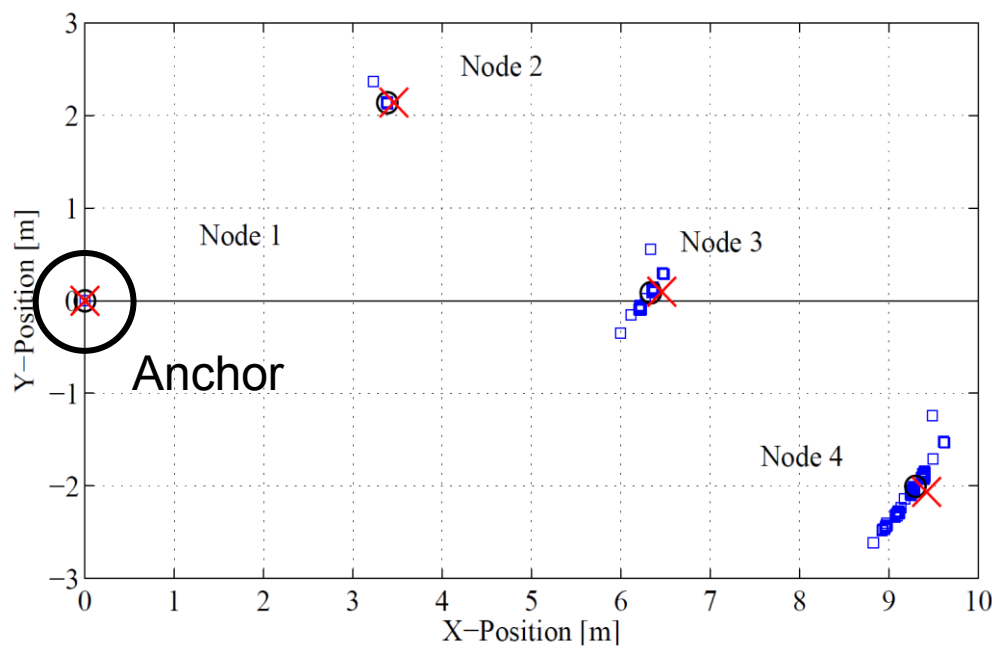

Step 1: Distance + angle to nearest neighbor

Std. dev. < 15.5 cm (6.1 inch)

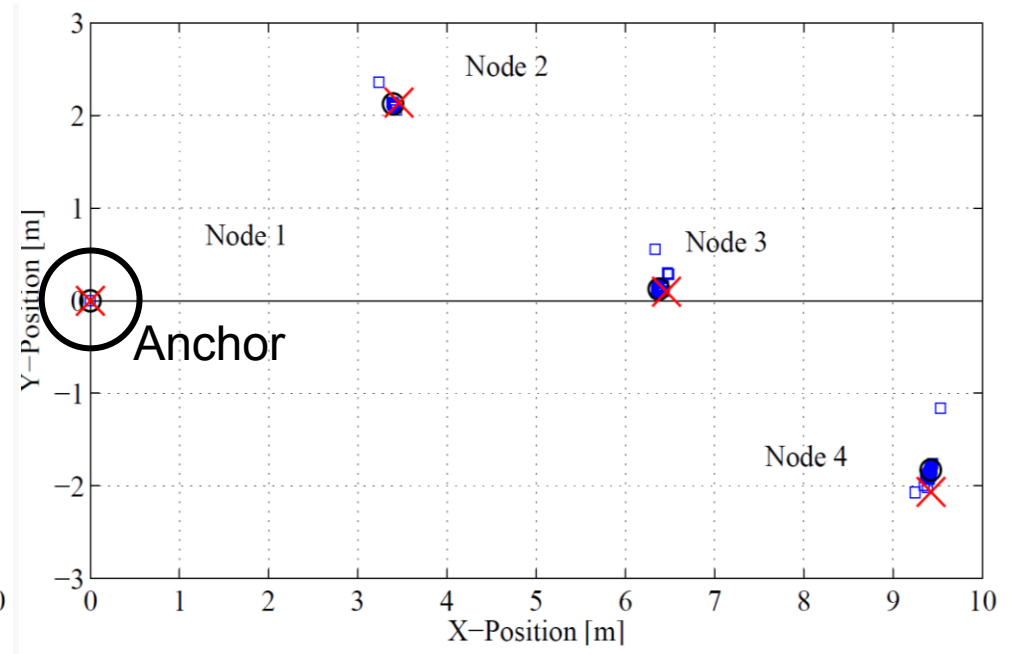

Step 2: Minimize distance errors
(method of least squares)

Std. dev. < 5.7 cm (2.2 inch)

Non Line-of-Sight Propagation

- What if the direct path between two nodes is obstructed?

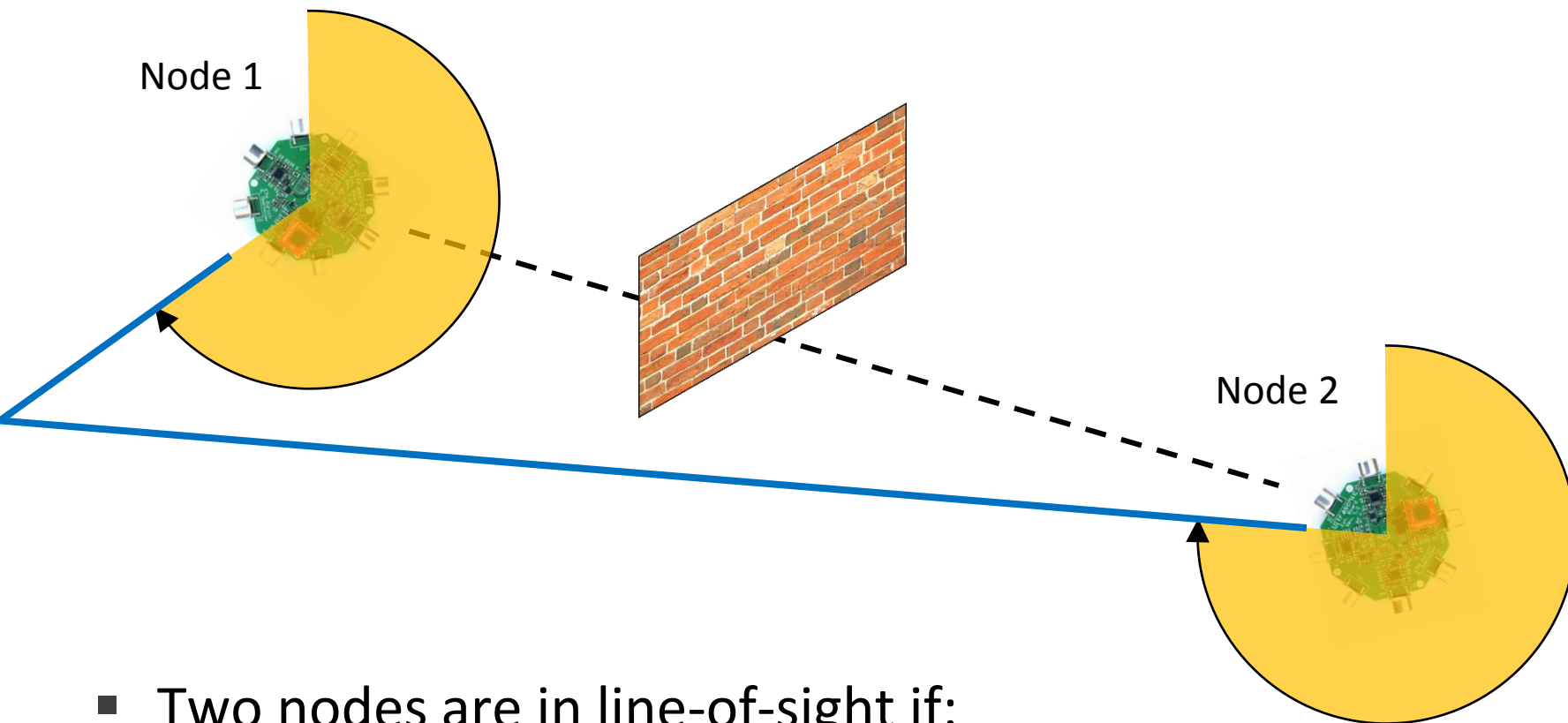

- Two nodes are in line-of-sight if:

$$\alpha_{\text{Node1}} = \alpha_{\text{Node2}} - \pi \pm \epsilon$$

Non Line-of-Sight Propagation

- We use the digital compass to get the node orientation

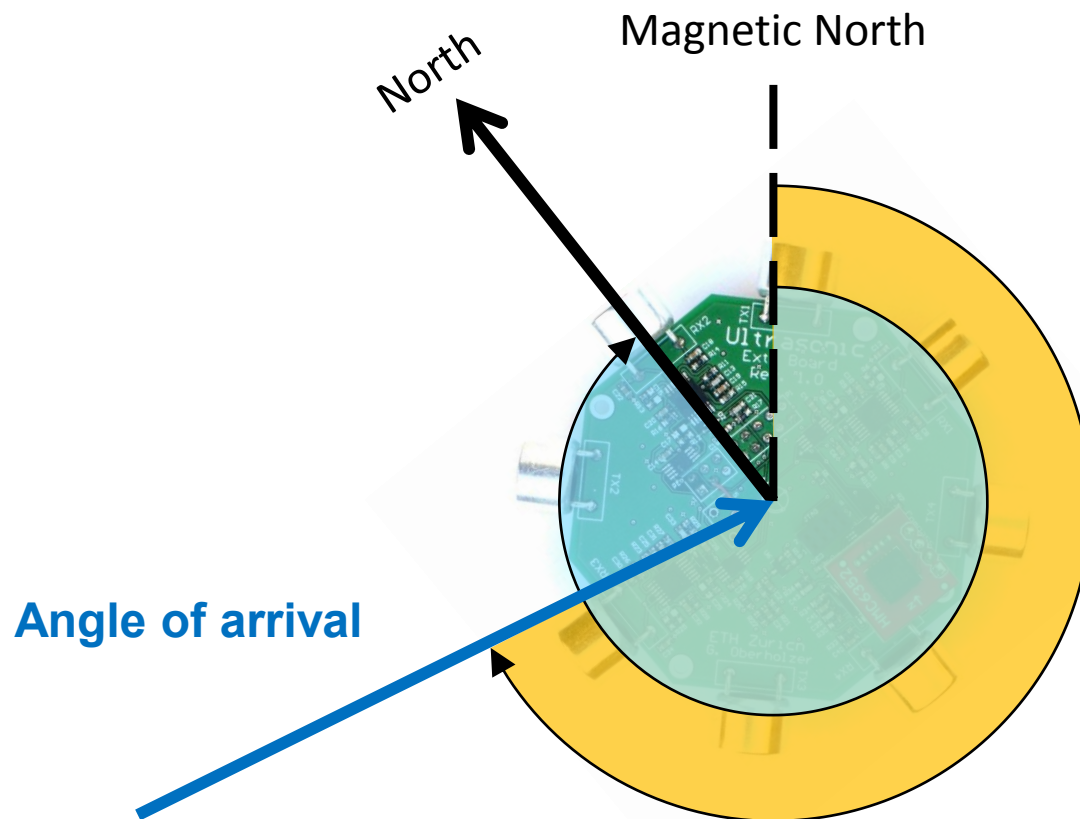

Honeywell HMC6352

We can use the digital compass to identify non-line of sight paths

Outlook: Learning about the Proximity of Nodes

- Sampling the received ultrasound signal

Idea: Identify reflection at nearby obstacles

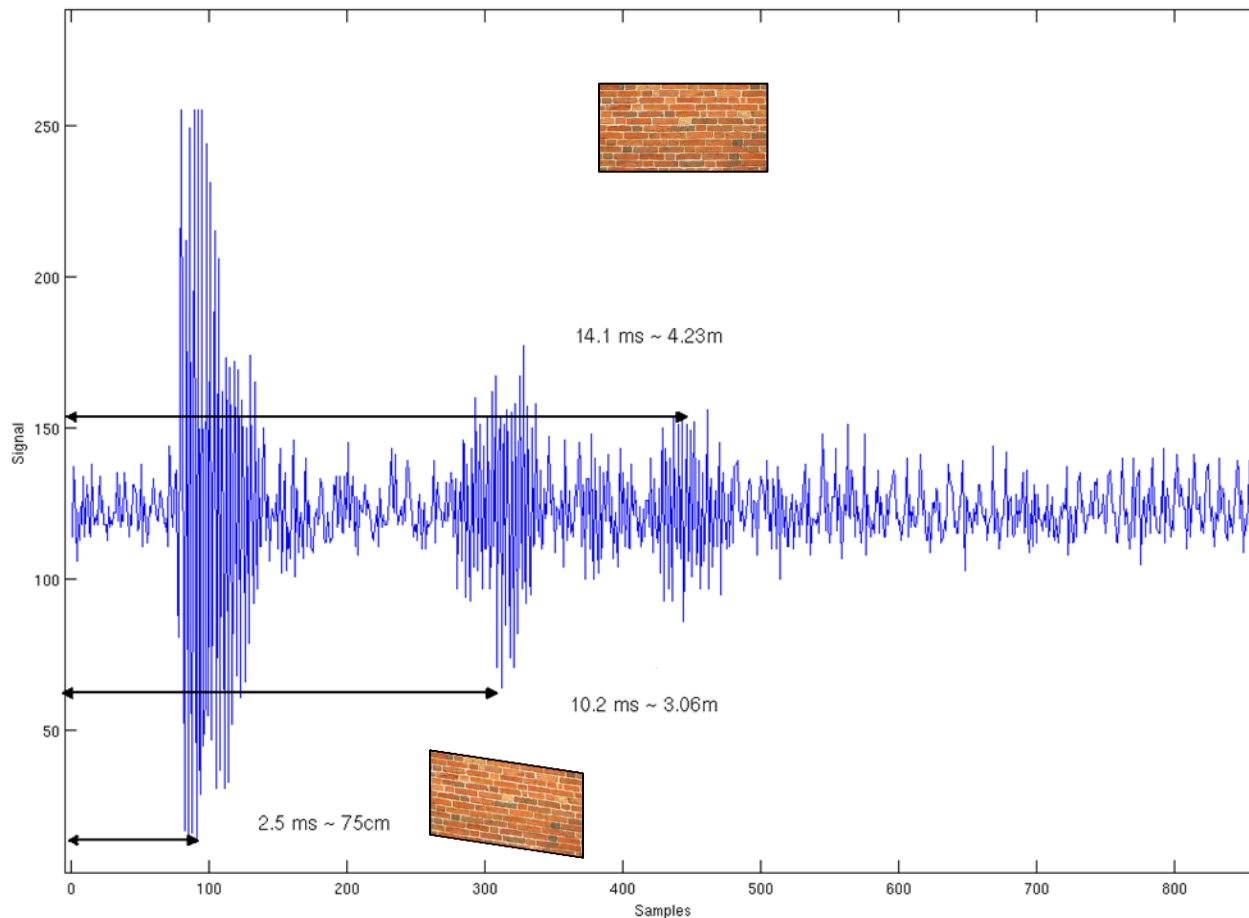

Conclusions

- SpiderBat platform

Ultrasound extension board for sensor nodes

Distance and **angle** measurements

Digital compass

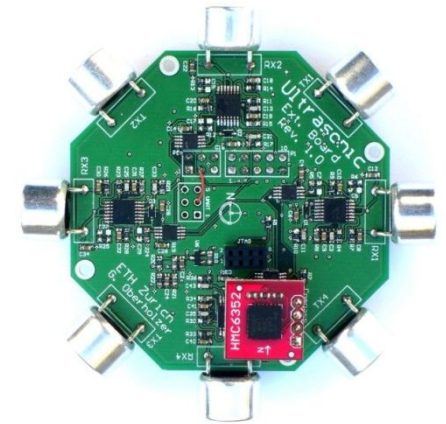

- Experiments

Std. dev. of localization error below 5.7 cm
(indoor setup)

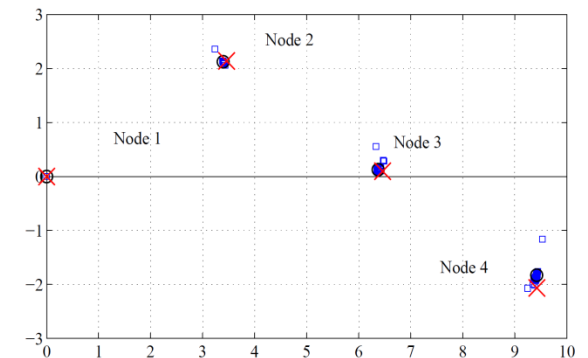

- Non-line of sight propagation

Detect obstacles between nodes

